

SAS to SAS/SATA RAID Subsystem

User Manual

Revision 1.2

Table of Contents

Preface	6
Before You Begin	7
Safety Guidelines.....	7
Controller Configurations.....	7
Packaging, Shipment and Delivery.....	7
Unpacking the Shipping Carton	8
Chapter 1 Product Introduction.....	9
1.1 Technical Specifications	11
1.2 RAID Concepts	13
1.3 Array Definition.....	18
1.3.1 Raid Set.....	18
1.3.2 Volume Set.....	18
1.4 High Availability.....	19
1.4.1 Creating Hot Spares.....	19
1.4.2 Hot-Swap Disk Drive Support	19
1.4.3 Hot-Swap Disk Rebuild	19
Chapter 2 Identifying Parts of the RAID Subsystem.....	20
2.1 Main Components.....	20
2.1.1 Front View.....	20
2.1.1.1 Disk Trays	21
2.1.1.2 Smart Panel	22
2.1.1.3 LCD IP Address in Dual Controller Mode	24
2.1.2 Rear View	25
2.1.3 Controller Module.....	26
2.1.3.1 Controller Module Panel.....	26
2.1.4 Power Supply / Fan Module (PSFM).....	28
2.1.4.1 PSFM Panel.....	28
Chapter 3 Getting Started with the Subsystem.....	30
3.1 Preparing the RAID Subsystem and Powering On	30
3.2 Powering On	30
3.3 Disk Drive Installation.....	31
3.3.1 Installing 3.5" SAS Disk Drive in a Disk Tray	31
3.3.2 Installing 2.5" Disk Drive in a Disk Tray.....	34

Chapter 4 RAID Configuration Utility Options	36
4.1 Configuration through Telnet.....	36
4.2 Configuration through the LCD Panel.....	41
4.2.1 Menu Diagram.....	42
4.3 Configuration through web browser-based proRAID Manager.....	49
Chapter 5 RAID Management.....	51
5.1 Quick Function.....	51
5.1.1 Quick Create.....	51
5.2 RAID Set Functions.....	53
5.2.1 Create RAID Set.....	53
5.2.2 Delete RAID Set.....	54
5.2.3 Expand RAID Set.....	55
5.2.4 Offline RAID Set.....	58
5.2.5 Rename RAID Set.....	59
5.2.6 Activate Incomplete RAID Set.....	60
5.2.7 Create Hot Spare.....	62
5.2.8 Delete Hot Spare.....	63
5.2.9 Rescue Raid Set.....	64
5.3 Volume Set Function.....	65
5.3.1 Create Volume Set.....	65
5.3.2 Create Raid 30/50/60.....	69
5.3.3 Delete Volume Set.....	70
5.3.4 Modify Volume Set.....	71
5.3.4.1 Volume Set Expansion.....	72
5.3.4.2 Volume Set Migration.....	73
5.3.5 Check Volume Set.....	74
5.3.6 Schedule Volume Check.....	76
5.3.7 Stop Volume Check.....	77
5.4 Security Functions.....	78
5.4.1 Create SED RAID Set.....	79
5.4.2 Delete SED RAID Set.....	81
5.4.3 Delete ISE RAID Set.....	82
5.4.4 Security Key Setup.....	83
5.4.4.1 Create Security Key.....	83
5.4.4.2 Modify Security Key.....	84
5.4.5 Import Security Key.....	86
5.4.6 Erase Failed Disk.....	87
5.4.7 RevertSP.....	87
5.4.8 SED Information.....	88

5.5	Physical Drive.....	91
5.5.1	Create Pass-Through Disk.....	91
5.5.2	Modify a Pass-Through Disk.....	92
5.5.3	Delete Pass-Through Disk.....	93
5.5.4	Clone Disk.....	93
5.5.4.1	Clone And Replace	95
5.5.4.2	Clone Only	95
5.5.5	Abort Cloning.....	95
5.5.6	Set Disk To Be Failed.....	96
5.5.7	Activate Failed Disk	97
5.5.8	Identify Enclosure.....	98
5.5.9	Identify Selected Drive.....	98
5.6	System Controls.....	99
5.6.1	System Configuration.....	99
5.6.2	Advanced Configuration	102
5.6.3	HDD Power Management	107
5.6.4	EtherNet Configuration	109
5.6.5	Alert By Mail Configuration.....	110
5.6.6	SNMP Configuration.....	111
5.6.7	NTP Configuration	112
5.6.8	View Events / Mute Beeper.....	113
5.6.9	Generate Test Event.....	114
5.6.10	Clear Event Buffer.....	114
5.6.11	Modify Password.....	115
5.6.12	Upgrade Firmware.....	115
5.6.13	Shutdown Controller.....	116
5.6.14	Restart Controller.....	116
5.7	Information Menu	117
5.7.1	RAID Set Hierarchy.....	117
5.7.1.1	Hdd Xfer Speed.....	118
5.7.2	SAS Chip Information.....	120
5.7.3	System Information	121
5.7.4	Hardware Monitor.....	122
Chapter 6	System Maintenance	125
6.1	Upgrading the RAID Controller's Cache Memory.....	125
6.1.1	Installing Memory Module.....	125
6.2	Upgrading the RAID Controller's Firmware.....	126
6.3	Upgrading the Expander Firmware	133
6.4	Replacing Subsystem Components	135

6.4.1	Replacing Controller Module.....	135
6.4.1.1	Replacing Controller Module with Controller Blanking Plate.....	135
6.4.2	Replacing Power Supply Fan Module.....	136
6.4.2.1	Replacing Power Supply Fan Module with Plate Cover.....	137

Preface

About this manual

This manual provides information regarding the hardware features, installation and configuration of the **SAS-to-SAS RAID subsystem**. This document also describes how to use the storage management software. Information contained in the manual has been reviewed for accuracy, but not for product warranty because of the various environment/OS/settings. Information and specifications will be changed without further notice.

This manual uses section numbering for every topic being discussed for easy and convenient way of finding information in accordance with the user's needs. The following icons are being used for some details and information to be considered in going through with this manual:

**NOTES:**

These are notes that contain useful information and tips that the user must give attention to in going through with the subsystem operation.

**IMPORTANT!**

These are the important information that the user must remember.

**WARNING!**

These are the warnings that the user must follow to avoid unnecessary errors and bodily injury during hardware and software operation of the subsystem.

**CAUTION:**

These are the cautions that user must be aware of to prevent damage to the subsystem and/or its components.

Copyright

No part of this publication may be reproduced, stored in a retrieval system, or transmitted in any form or by any means, electronic, mechanical, photocopying, recording or otherwise, without the prior written consent.

Trademarks

All products and trade names used in this document are trademarks or registered trademarks of their respective owners.

Changes

The material in this document is for information only and is subject to change without notice.

Before You Begin

Before going through with this manual, you should read and focus on the following safety guidelines. Notes about the subsystem's controller configuration and the product packaging and delivery are also included here.

Safety Guidelines

To provide reasonable protection against any harm on the part of the user and to obtain maximum performance, user is advised to be aware of the following safety guidelines particularly in handling hardware components:

Upon receiving of the product:

- ❖ Place the product in its proper location.
- ❖ Do not try to lift it by yourself alone. Two or more persons are needed to remove or lift the product to its packaging. To avoid unnecessary dropping out, make sure that somebody is around for immediate assistance.
- ❖ It should be handled with care to avoid dropping that may cause damage to the product. Always use the correct lifting procedures.

Upon installing of the product:

- ❖ Ambient temperature is very important for the installation site. It must not exceed 30°C. Due to seasonal climate changes; regulate the installation site temperature making it not to exceed the allowed ambient temperature.
- ❖ Before plugging-in any power cords, cables and connectors, make sure that the power switches are turned off. Disconnect first any power connection if the power supply module is being removed from the enclosure.
- ❖ Outlets must be accessible to the equipment.
- ❖ All external connections should be made using shielded cables and as much as possible should not be performed by bare hand. Using anti-static hand gloves is recommended.
- ❖ In installing each component, secure all the mounting screws and locks. Make sure that all screws are fully tightened. Follow correctly all the listed procedures in this manual for reliable performance.

Controller Configurations

This RAID subsystem supports both single controller and dual controller configurations. The single controller can be configured depending on the user's requirements. On the other side, these controllers can be both configured and be active to increase system efficiency and to improve performance.

This manual will discuss both single and dual controller configuration.

Packaging, Shipment and Delivery

- ❖ Before removing the subsystem from the shipping carton, you should visually inspect the physical condition of the shipping carton.
- ❖ Unpack and verify that the contents of the shipping carton are complete and in good condition.
- ❖ Exterior damage to the shipping carton may indicate that the contents of the carton are damaged.
- ❖ If any damage is found, do not remove the components; contact the dealer where you purchased the subsystem for further instructions.

Unpacking the Shipping Carton

The shipping package contains the following:

	<p>RAID Subsystem Unit</p>
	<p>Two (2) power cords</p>
	<p>One (1) external SAS cable for single RAID controller Note: Two SAS cables for dual RAID controllers</p>
	<p>One (1) RJ45 Ethernet cable for single RAID controller Note: Two Ethernet cables for dual RAID controllers</p>
	<p>One (1) external serial cable RJ11-to-DB9 for single RAID controller Note: Two serial cables for dual RAID controllers</p>
	<p>One(1) Controller Blanking Plate Note: For dual RAID controller</p>
	<p>One(1) PSFM Plate Cover</p>
	<p>User Manual</p>

NOTE: If any damage is found, contact the dealer or vendor for assistance.

Chapter 1 Product Introduction



The 12 bays RAID Subsystem

The RAID subsystem features 12Gb SAS host performance to increase system efficiency and performance. It features high capacity expansion, with 12 hot-swappable SAS3/SATA3 hard disk drive bays in a 19-inch 2U rackmount unit, scaling to a maximum storage capacity in the terabyte range. The subsystem also supports dual controllers which provide better fault tolerance and higher reliability of system operation.

Controller Redundancy

- Dual-active RAID controller with cache mirroring through dedicated high speed bus
- Automatic synchronization of firmware version in the dual-active mode
- Redundant controller operation with active/active and failover/failback function
- Redundant flash image for controller availability
- Management port seamless take-over

High availability

- DataBolt™ Bandwidth Optimizer for balance faster host and slower SAS or SATA devices
- RAID level 0, 1,10(1E), 3, 5, 6, 30, 50, 60, 00, 100, Single Disk and JBOD

Unparalleled Drive Support

- Support for native 4K and 512 byte sector SAS and SATA devices
- Support HDD firmware update
- SSD automatic monitor clone (AMC) support
- S.M.A.R.T. support

Energy Saving

- Low power consumption & Low heat production
- Support intelligent power management to save energy and extend service life

RAID Management

- Access terminal menu by telnet via a LAN port
- API library for customer to write its own monitor utility
- Field-upgradeable firmware in flash ROM
- Firmware-embedded manager via RS-232 port
- Firmware-embedded Web Browser-based RAID manager allows local or remote management and configuration
- SAP management utility to easily manage multiple RAID units in the network

1.1 Technical Specifications

RAID controller	12Gb SAS – 12Gb SAS
Controller	Single or Redundant
Host Interface	Two / Four 4x mini SAS HD (12Gb/s) (SFF-8644)
Disk Interface	12Gb/s SAS, 6Gb/s SATA HDD/SSD
SAS expansion	One / Two 12Gb/s SAS (SFF-8644)
Capacity	
Direct attached	12 Disks
Expansion	Up to 256 Disks
Processor type	1.2GHz Dual Core RAID-On-Chip processor
Cache memory	2GB ~ 8GB / 4GB ~ 16GB DDR3-1866 ECC SDRAM
Management Port Support	2 x RJ11 Serial Ports; 1 x RJ45 Ethernet Port
Battery Backup Module(BBM)	Optional
Flash-based Backup module (FBM)	Optional
RAID Features	
RAID level	0, 1,10(1E), 3, 5, 6, 30, 50, 60, 00, 100, Single Disk and JBOD
LUNs	Up to 128
Hot Spare	Global and Dedicated
Stripe Size	Up to 1024KB
Cache writing approaches	Write-through or write-back
Online Rebuild	Yes
Automatic drive insertion/removal detection	Yes
Multiple RAID selection	Yes
Online Array roaming	Yes
Online RAID level / stripe size migration	Yes
Online capacity expansion	Yes
Online volume set growth	Yes
SNMP manager	Yes

E-mail Notification	Yes
Instant availability and background initialization	Yes
HDD Xfer Speed Test	Yes
Real time clock support	Yes
RAID clock Synchronization	Yes (Using NTP)
Multiple pairs SSD/HDD disk clone	Yes
Multi-Path I/O (MPIO) Support	Yes
Platform	Rackmount
Form Factor	2U
# of hot swap trays	12
Tray Lock	Yes
Disk status indicator	Access / Fail LED
Backplane	SAS3 Single BP
# of PS/Fan modules	400W x 2 w/PFC
# of fans	2
Power Requirements	AC 90V ~ 264V Full Range 8A~4A, 47Hz~63Hz
Environmental	
Relative Humidity	10% ~ 85% Non-condensing
Operating Temperature	10°C ~ 40°C (50°F ~ 104°F)
Physical Dimension	590(L) x 482 (W) x 88(H) mm
Weight (Without Disk)	18.2 / 19.7 Kg

Note: Specifications are subject to change without notice. All company and product names are trademarks of their respective owners.

1.2 RAID Concepts

RAID Fundamentals

The basic idea of RAID (Redundant Array of Independent Disks) is to combine multiple inexpensive disk drives into an array of disk drives to obtain performance, capacity and reliability that exceeds that of a single large drive. The array of drives appears to the host computer as a single logical drive.

Five types of array architectures, RAID 1 through RAID 5, were originally defined; each provides disk fault-tolerance with different compromises in features and performance. In addition to these five redundant array architectures, it has become popular to refer to a non-redundant array of disk drives as a RAID 0 arrays.

Disk Striping

Fundamental to RAID technology is striping. This is a method of combining multiple drives into one logical storage unit. Striping partitions the storage space of each drive into stripes, which can be as small as one sector (512 bytes) or as large as several megabytes. These stripes are then interleaved in a rotating sequence, so that the combined space is composed alternately of stripes from each drive. The specific type of operating environment determines whether large or small stripes should be used.

Most operating systems today support concurrent disk I/O operations across multiple drives. However, in order to maximize throughput for the disk subsystem, the I/O load must be balanced across all the drives so that each drive can be kept busy as much as possible. In a multiple drive system without striping, the disk I/O load is never perfectly balanced. Some drives will contain data files that are frequently accessed and some drives will rarely be accessed.

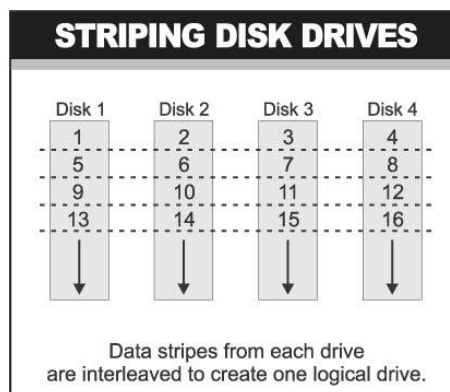

By striping the drives in the array with stripes large enough so that each record falls entirely within one stripe, most records can be evenly distributed across all drives. This keeps all drives in the array busy during heavy load situations. This situation allows all drives to work concurrently on different I/O operations, and thus maximize the number of simultaneous I/O operations that can be performed by the array.

Definition of RAID Levels

RAID 0 is typically defined as a group of striped disk drives without parity or data redundancy. RAID 0 arrays can be configured with large stripes for multi-user environments or small stripes for single-user systems that access long sequential records. RAID 0 arrays deliver the best data storage efficiency and performance of any array type. The disadvantage is that if one drive in a RAID 0 array fails, the entire array fails.

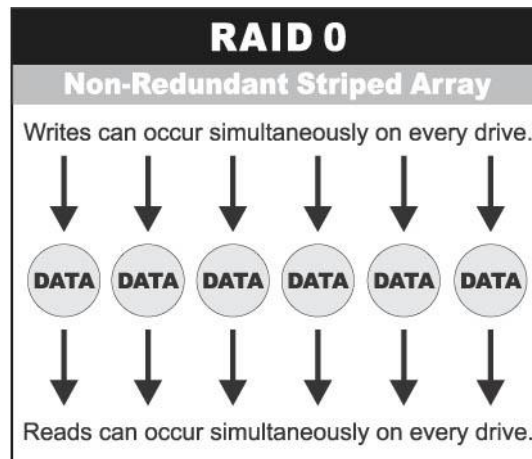

RAID 1, also known as disk mirroring, is simply a pair of disk drives that store duplicate data but appear to the computer as a single drive. Although striping is not used within a single mirrored drive pair, multiple RAID 1 arrays can be striped together to create a single large array consisting of pairs of mirrored drives. All writes must go to both drives of a mirrored pair so that the information on the drives is kept identical. However, each individual drive can perform simultaneous, independent read operations. Mirroring thus doubles the read performance of a single non-mirrored drive and while the write performance is unchanged. RAID 1 delivers the best performance of any redundant array type. In addition, there is less performance degradation during drive failure than in RAID 5 arrays.

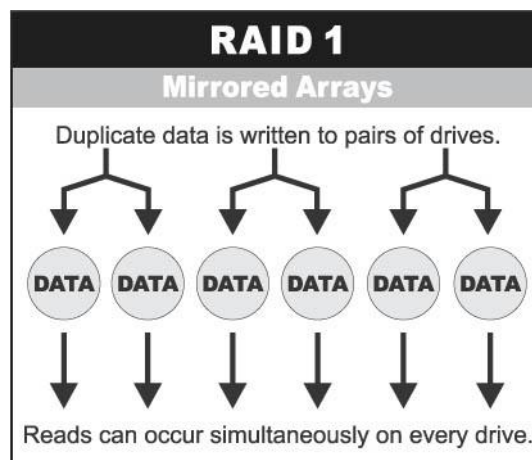

RAID 3 sector-stripes data across groups of drives, but one drive in the group is dedicated for storing parity information. RAID 3 relies on the embedded ECC in each sector for error detection. In the case of drive failure, data recovery is accomplished by calculating the exclusive OR (XOR) of the information recorded on the remaining drives. Records typically span all drives, which optimizes the disk transfer rate. Because each I/O request accesses every drive in the array, RAID 3 arrays can satisfy only one I/O request at a time. RAID 3 delivers the best performance for single-user, single-tasking environments with long records. Synchronized-spindle drives are required for RAID 3 arrays in order to avoid performance degradation with short records. RAID 5 arrays with small stripes can yield similar performance to RAID 3 arrays.

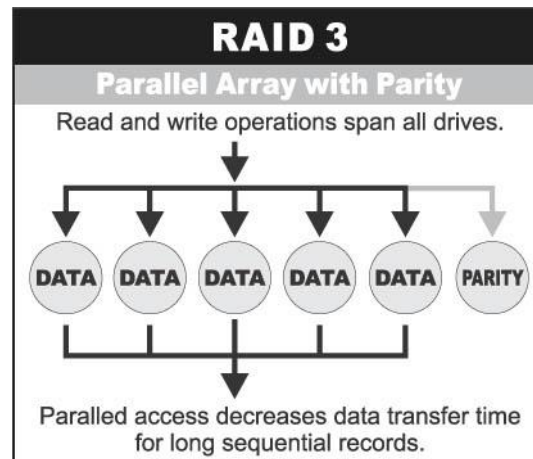

Under **RAID 5** parity information is distributed across all the drives. Since there is no dedicated parity drive, all drives contain data and read operations can be overlapped on every drive in the array. Write operations will typically access one data drive and one parity drive. However, because different records store their parity on different drives, write operations can usually be overlapped.

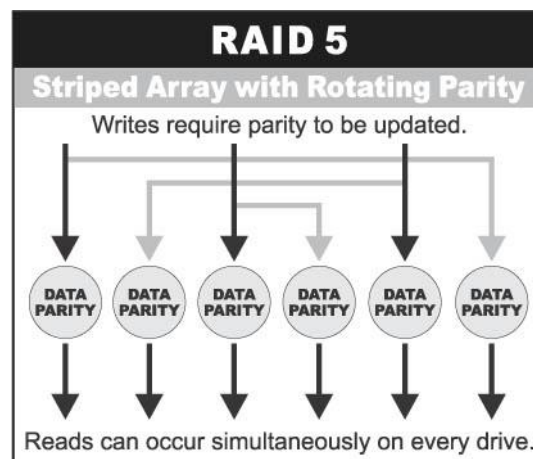

Dual-level RAID achieves a balance between the increased data availability inherent in RAID 1, RAID 3, RAID 5, or RAID 6 and the increased read performance inherent in disk striping (RAID 0). These arrays are sometimes referred to as RAID 10 (1E), RAID 30, RAID 50 or RAID 60.

RAID 6 is similar to RAID 5 in that data protection is achieved by writing parity information to the physical drives in the array. With RAID 6, however, **two** sets of parity data are used. These two sets are different, and each set occupies a capacity equivalent to that of one of the constituent drives. The main advantage of RAID 6 is High data availability – any two drives can fail without loss of critical data.

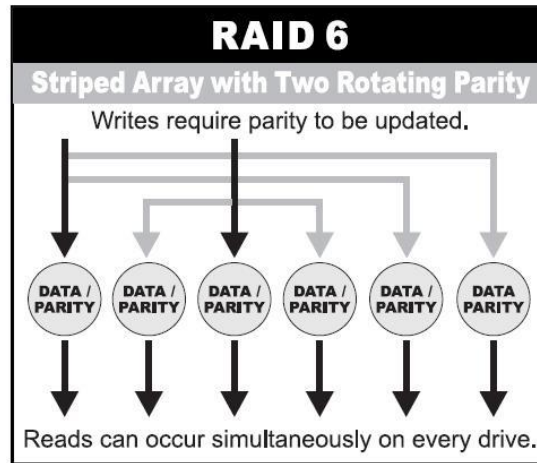

In summary:

- RAID 0 is the fastest and most efficient array type but offers no fault-tolerance. RAID 0 requires a minimum of one drive.
- RAID 1 is the best choice for performance-critical, fault-tolerant environments. RAID 1 is the only choice for fault-tolerance if no more than two drives are used.
- RAID 3 can be used to speed up data transfer and provide fault-tolerance in single-user environments that access long sequential records. However, RAID 3 does not allow overlapping of multiple I/O operations and requires synchronized-spindle drives to avoid performance degradation with short records. RAID 5 with a small stripe size offers similar performance.
- RAID 5 combines efficient, fault-tolerant data storage with good performance characteristics. However, write performance and performance during drive failure is slower than with RAID 1. Rebuild operations also require more time than with RAID 1 because parity information is also reconstructed. At least three drives are required for RAID 5 arrays.
- RAID 6 is essentially an extension of RAID level 5 which allows for additional fault tolerance by using a second independent distributed parity scheme (two-dimensional parity). Data is striped on a block level across a set of drives, just like in RAID 5, and a second set of parity is calculated and written across all the drives; RAID 6 provides for an extremely high data fault tolerance and can sustain multiple simultaneous drive failures. It is a perfect solution for mission critical applications.

RAID Management

The subsystem can implement several different levels of RAID technology. RAID levels supported by the subsystem are shown below.

RAID Level	Description	Min. Drives
0	Block striping is provide, which yields higher performance than with individual drives. There is no redundancy.	1
1	Drives are paired and mirrored. All data is 100% duplicated on an equivalent drive. Fully redundant.	2
3	Data is striped across several physical drives. Parity protection is used for data redundancy.	3
5	Data is striped across several physical drives. Parity protection is used for data redundancy.	3
6	Data is striped across several physical drives. Parity protection is used for data redundancy. Requires N+2 drives to implement because of two-dimensional parity scheme.	3
10(1E)	Combination of RAID levels 1 and 0. This level provides striping and redundancy through mirroring. RAID 10 requires the use of an <u>even number</u> of disk drives to achieve data protection, while RAID 1E (Enhanced Mirroring) uses an <u>odd number of drives</u> .	3
30	Combination of RAID levels 0 and 3. This level is best implemented on two RAID 3 disk arrays with data striped across both disk arrays.	6
50	RAID 50 provides the features of both RAID 0 and RAID 5. RAID 50 includes both parity and disk striping across multiple drives. RAID 50 is best implemented on two RAID 5 disk arrays with data striped across both disk arrays.	6
60	RAID 60 combines both RAID 6 and RAID 0 features. Data is striped across disks as in RAID 0, and it uses double distributed parity as in RAID 6. RAID 60 provides data reliability, good overall performance and supports larger volume sizes. RAID 60 also provides very high reliability because data is still available even if multiple disk drives fail (two in each disk array).	6
00	Two levels of block-level striping. There is no redundancy. Maximum 32 disks per Raid Set. If you need to create Raid Set over 32 disks, use RAID 00.	6
100	Combination of RAID levels 10 and 0. Mirroring without parity, and two levels of block-level striping.	6

1.3 Array Definition

1.3.1 Raid Set

A Raid Set is a group of disk drives containing one or more logical volumes called Volume Sets. It is not possible to have multiple Raid Sets on the same disk drives.

A Volume Set must be created either on an existing Raid Set or on a group of available individual disk drives (disk drives that are not yet a part of a Raid Set). If there are existing Raid Sets with available raw capacity, new Volume Set can be created. New Volume Set can also be created on an existing Raid Set without free raw capacity by expanding the Raid Set using available disk drive(s) which is/are not yet Raid Set member. If disk drives of different capacity are grouped together in a Raid Set, then the capacity of the smallest disk will become the effective capacity of all the disks in the Raid Set.

1.3.2 Volume Set

A Volume Set is seen by the host system as a single logical device. It is organized in a RAID level with one or more physical disks. RAID level refers to the level of data performance and protection of a Volume Set. A Volume Set capacity can consume all or a portion of the raw capacity available in a Raid Set. Multiple Volume Sets can exist on a group of disks in a Raid Set. Additional Volume Sets created in a specified Raid Set will reside on all the physical disks in the Raid Set. Thus each Volume Set on the Raid Set will have its data spread evenly across all the disks in the Raid Set. Volume Sets of different RAID levels may coexist on the same Raid Set.

In the illustration below, Volume 1 can be assigned a RAID 5 level while Volume 0 might be assigned a RAID 10 level.

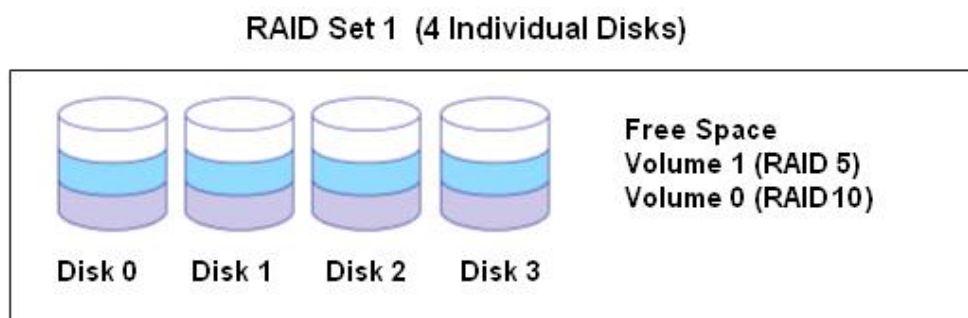

1.4 High Availability

1.4.1 Creating Hot Spares

A hot spare drive is an unused online available drive, which is ready to replace a failed disk drive. In a RAID level 1, 10, 3, 5, 6, 30, 50, 60 or 100 Raid Set, any unused online available drive installed but not belonging to a Raid Set can be defined as a hot spare drive. Hot spares permit you to replace failed drives without powering down the system. When the RAID subsystem detects a drive failure, the system will do automatic and transparent rebuild using the hot spare drives. The Raid Set will be reconfigured and rebuilt in the background while the RAID subsystem continues to handle system request. During the automatic rebuild process, system activity will continue as normal, however, the system performance and fault tolerance will be affected.



IMPORTANT: The hot spare must have at least the same or more capacity as the drive it replaces.

1.4.2 Hot-Swap Disk Drive Support

The RAID subsystem has built-in protection circuit to support the replacement of SATA II hard disk drives without having to shut down or reboot the system. The removable hard drive tray can deliver “hot swappable” fault-tolerant RAID solution at a price much less than the cost of conventional SCSI hard disk RAID subsystems. This feature is provided in the RAID subsystem for advance fault tolerant RAID protection and “online” drive replacement.

1.4.3 Hot-Swap Disk Rebuild

The Hot-Swap feature can be used to rebuild Raid Sets with data redundancy such as RAID level 1, 10, 3, 5, 6, 30, 50, 60 and 100. If a hot spare is not available, the failed disk drive must be replaced with a new disk drive so that the data on the failed drive can be rebuilt. If a hot spare is available, the rebuild starts automatically when a drive fails. The RAID subsystem automatically and transparently rebuilds failed drives in the background with user-definable rebuild rates. The RAID subsystem will automatically continue the rebuild process if the subsystem is shut down or powered off abnormally during a reconstruction process.

Chapter 2 Identifying Parts of the RAID Subsystem

2.1 Main Components

2.1.1 Front View

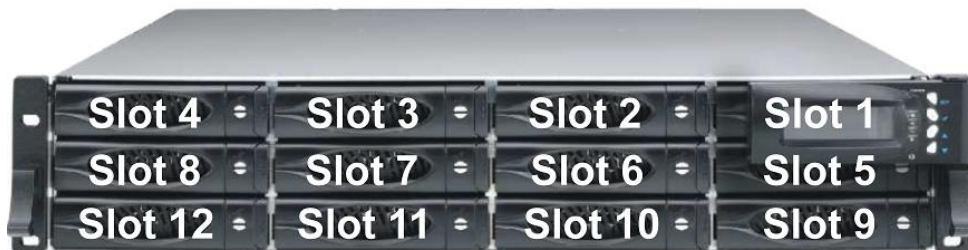

2.1.1.1 Disk Trays



HDD Status Indicator

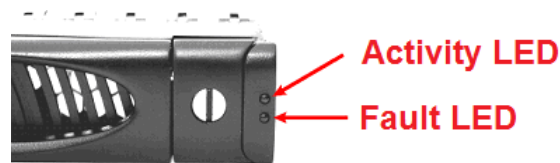

Part	Function
HDD Activity LED	This LED will blink blue when the hard drive is being accessed.
HDD Fault LED	Green LED indicates power is on and hard drive status is good for this slot. If there is no hard drive, the LED is red. If hard drive defected in this slot or the hard drive is failure, the LED is blinking red.

Lock Indicator

Every Disk Tray is lockable and is fitted with a lock indicator to indicate whether or not the tray is locked into the chassis or not. Each tray is also fitted with an ergonomic handle for easy tray removal.

When the Lock Groove is horizontal, this indicates that the Disk Tray is locked. When the Lock Groove is vertical, then the Disk Tray is unlocked.

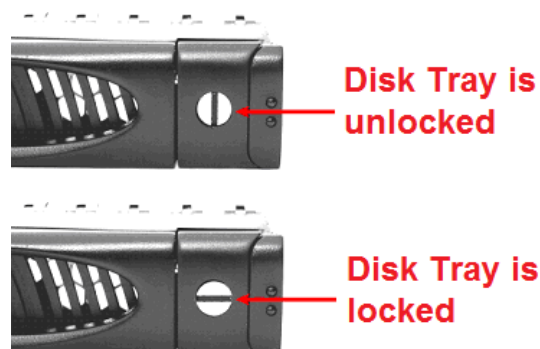

2.1.1.2 Smart Panel



Smart Function Keys

PARTS	FUNCTION
Up and Down Arrow buttons ▲ ▼	<p>Use the Up or Down arrow keys to go through the information on the LCD screen. This is also used to move between each menu when you configure the subsystem.</p> <p>NOTE: When the Down Arrow button ▼ is pressed 3 times, the LCD control will shift to the other RAID controller (in redundant controller mode) and the other RAID controller's IP address will be shown in LCD.</p>
Select button ▼	This is used to enter the option you have selected.
Exit button EXIT	<p>Press this button to return to the previous menu.</p> <p>NOTE: This button can also be used to reset the alarm beeper.</p>

Environment Status LEDs

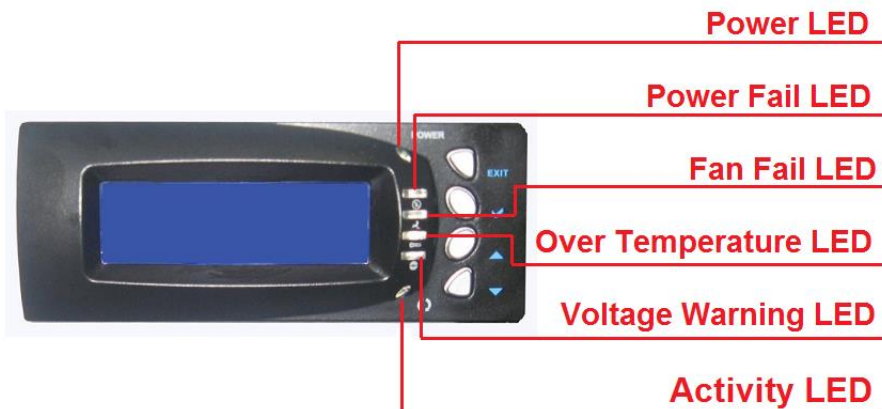

Parts	Function
Power LED	Green LED indicates power is ON.
Power Fail LED	If a redundant power supply unit fails, this LED will turn to RED and alarm will sound.
Fan Fail LED	When a fan fails or the fan's rotational speed is below 700RPM, this LED will turn red and an alarm will sound.
Over Temperature LED	If temperature irregularities in the system occurs (HDD slot temperature over 65°C, Controller temperature over 80°C, CPU Temperature over 90°C), this LED will turn RED and alarm will sound.
Voltage Warning LED	An alarm will sound warning of a voltage abnormality and this LED will turn red.
Activity LED	This LED will blink blue when the RAID subsystem is busy or active.

2.1.1.3 LCD IP Address in Dual Controller Mode

In dual controller mode, the RAID subsystem has 2 IP addresses which can be accessed separately.

By default, the IP address of Controller 1 is shown.

To view the IP address of Controller 2, press the "Down Arrow" ▼ button in the front panel three (3) times.

When the IP address of Controller 1 is shown, there is no blinking rectangular character at the end of the IP address.

When the IP address of Controller 2 is shown, there is a blinking rectangular character at the end of the IP address.

When the IP address has a link (connected to network), there is an "*" at the end of the IP address. When there is no link, there is no "*".

Controller 1 IP Address (No rectangular character)



Controller 1 has Link



Controller 1 has no Link

Controller 2 IP Address (With rectangular character blinking)



Controller 2 has Link



Controller 2 has no Link

2.1.2 Rear View

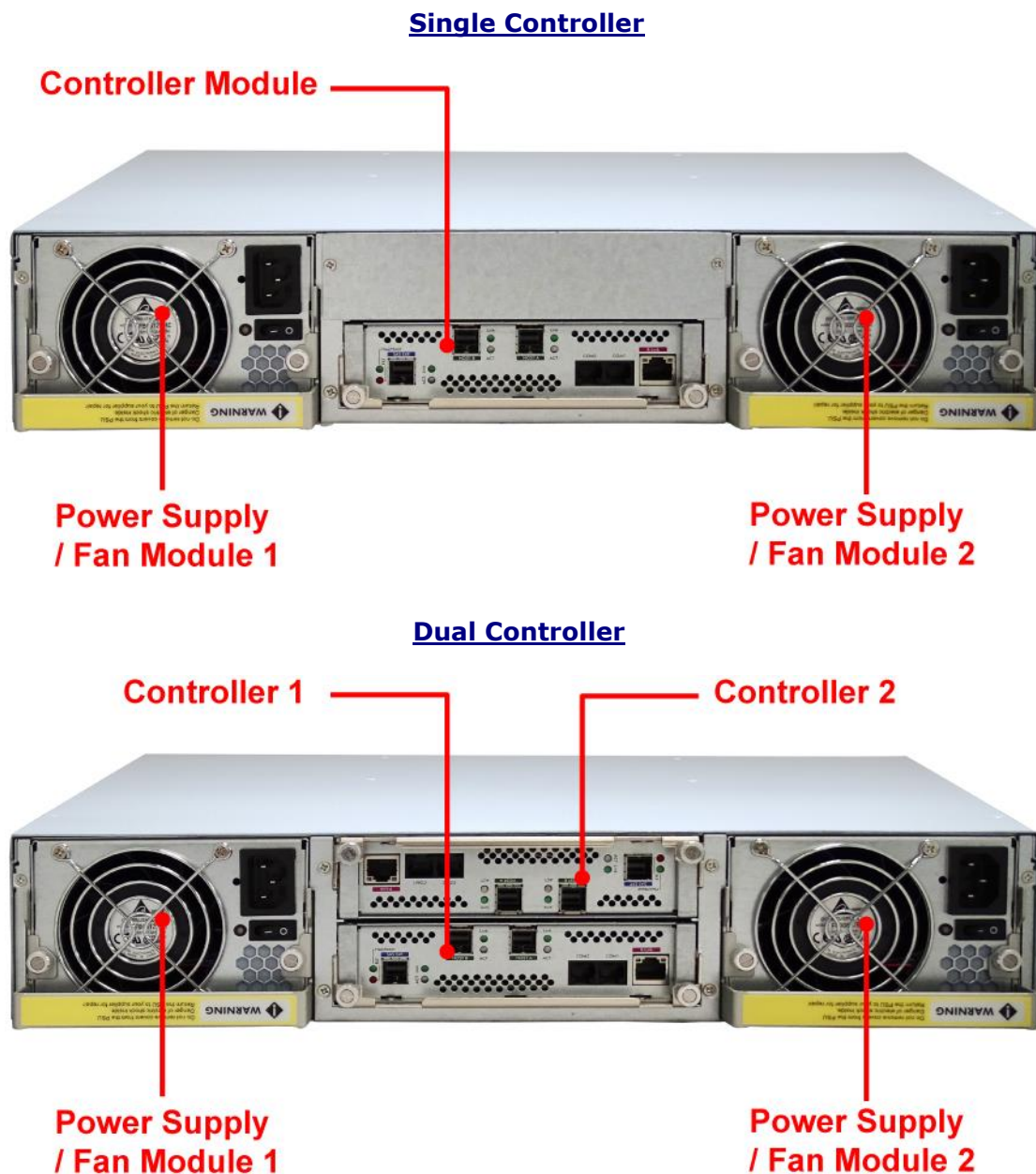

Controller Module – The subsystem has single or dual controller modules.

Power Supply / Fan Module #1, #2 – Two power supply / fan modules are located at the rear of the subsystem.

If the power supply fails to function, the  Power Fail LED will turn red and an alarm will sound. An error message will also appear on the LCD screen warning of power failure.

The fan in a power supply fan module is powered independently. When a power supply fails, the fan will still be working and provides airflow inside the enclosure.

2.1.3 Controller Module



RAID Controller Module

2.1.3.1 Controller Module Panel

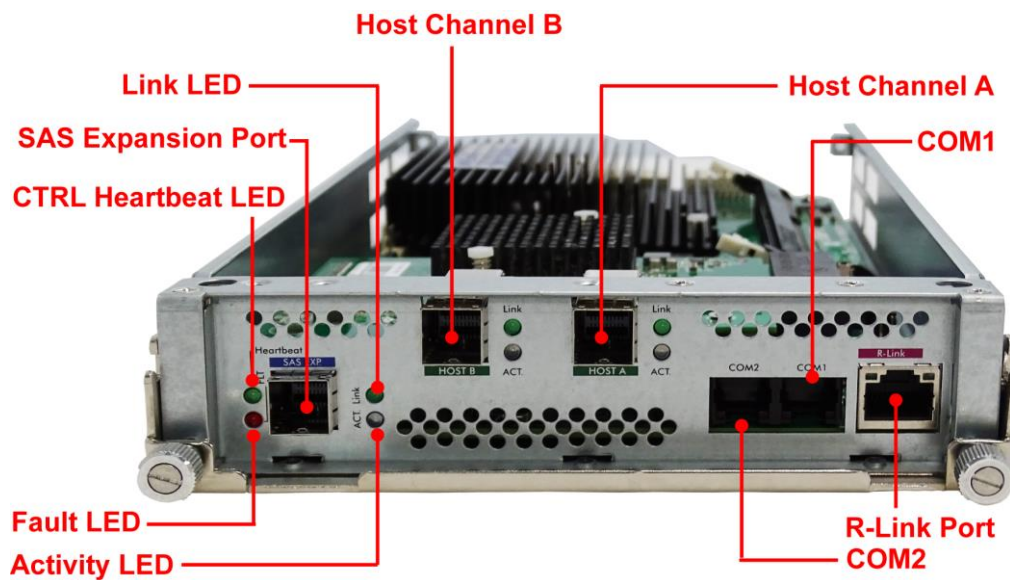

Note: Only one host cable is included in the package. Additional host cables are optional and can be purchased separately for upgrade.

Part	Description
Host Channel A, B	Two host channels (A and B) are available and can be use to connect to SAS HBA on the Host system, or to connect to SAS switch.
SAS Expansion Port	Use for expansion; connect to the SAS In Port of a JBOD subsystem.
COM2	RJ-11 port; Use to connect to CLI (command line interface) for example to upgrade expander firmware. See section 6.3 <i>Upgrading the Expander Firmware</i> .
COM1	RJ-11 port; Use to check controller debug messages
R-Link Port	10/100/1000 Ethernet RJ-45 port; Use to manage the RAID subsystem via network and web browser.

Indicator LED	Color	Description
Link LED	Green	Indicates Host Channel has connected or linked.
	Blue	Indicates the Host Channel is busy and being accessed.
Activity LED	Green	Indicates expander has connected or linked.
	Blue	Indicates the expander is busy and being accessed.
Fault LED	Blink RED	Indicates that controller has failed.
CTRL Heartbeat LED	Blink Green	Indicates that controller is working fine.
	Solid Green	Indicates that controller is hung.

2.1.4 Power Supply / Fan Module (PSFM)

The RAID subsystem contains **two 400W Power Supply / Fan Modules**. All the Power Supply / Fan Modules (PSFM) are inserted into the rear of the chassis.



2.1.4.1 PSFM Panel



The panel of the Power Supply/Fan Module contains: the Power On/Off Switch, the AC Inlet Plug, and a Power On/Fail Indicator showing the Power Status LED, indicating ready or fail.

Each fan within a PSFM is powered independently of the power supply within the same PSFM. So if the power supply of a PSFM fails, the fan associated with that PSFM will continue to operate and cool the enclosure.

When the power cord connected from main power source is inserted to the AC Power Inlet, the power status LED becomes **RED**. When the switch of the PSFM is turned on, the LED will turn **GREEN**. When the Power On/Fail LED is **GREEN**, the PSFM is functioning normally.



NOTE: Each PSFM has one Power Supply and one Fan. PSFM 1 has Power#1 and Fan#1, and PSFM 2 has Power#2 and Fan#2. When the Power Supply of a PSFM fails, the PSFM need not be removed from the slot if replacement is not yet available. The fan will still work and provide necessary airflow inside the enclosure.

In replacing the failed PSFM, refer to Appendix section of this manual.



NOTE: After replacing the Power Supply Fan Module and turning on the Power On/Off Switch of the PSFM, the Power Supply will not power on immediately. The Fan in the PSFM will spin-up until the RPM becomes stable. When Fan RPM is already stable, the RAID controller will then power on the Power Supply. This process takes more or less 30 seconds. This safety measure helps prevent possible Power Supply overheating when the Fan cannot work.

Chapter 3 Getting Started with the Subsystem

3.1 Preparing the RAID Subsystem and Powering On

1. Place the RAID subsystem in its proper place.
2. Connect the SAS cable(s) to the SAS Host Channel(s).
3. Attach network cable to the R-Link port. Connect the other end to your network hub or switch.

3.2 Powering On

1. Plug in the power cords into the AC Power Input Socket located at the rear of the subsystem.

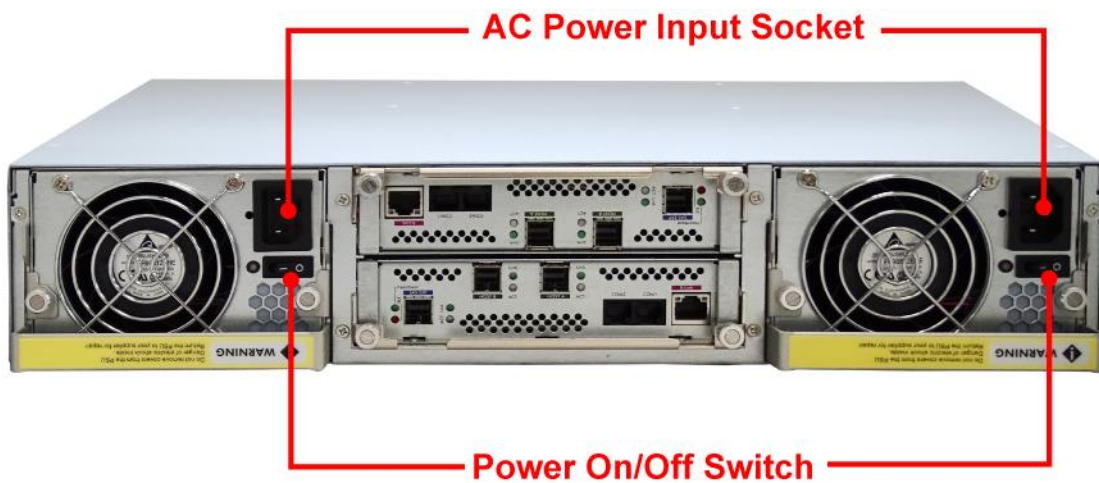

NOTE: The subsystem is equipped with redundant, full range power supplies with PFC (power factor correction). The system will automatically select voltage.

2. Turn on each Power On/Off Switch to power on the subsystem.
3. The Power LED on the front Panel will turn green.

3.3 Disk Drive Installation

This section describes the physical locations of the hard drives supported by the subsystem and give instructions on installing a hard drive. The subsystem supports hot-swapping allowing you to install or replace a hard drive while the subsystem is running.

3.3.1 Installing 3.5" SAS Disk Drive in a Disk Tray



NOTE: These steps are the same when installing SATA disk drive in Single Controller Mode.

1. Unlock the Disk Trays using a flat-head screw driver by rotating the Lock Groove.

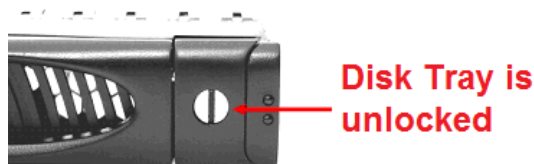

2. Press the Tray Open button and the Disk Tray handle will flip open.



3. Pull out an empty disk tray.



- Place the hard drive in the disk tray. Turn the disk tray upside down. Align the four screw holes of the SAS disk drive in the four Hole A of the disk tray. To secure the disk drive into the disk tray, tighten four screws on these holes of the disk tray. Note in the picture below where the screws should be placed in the disk tray holes.



NOTE: The mounting hole locations of the new 6-disk are different from the existing drives.

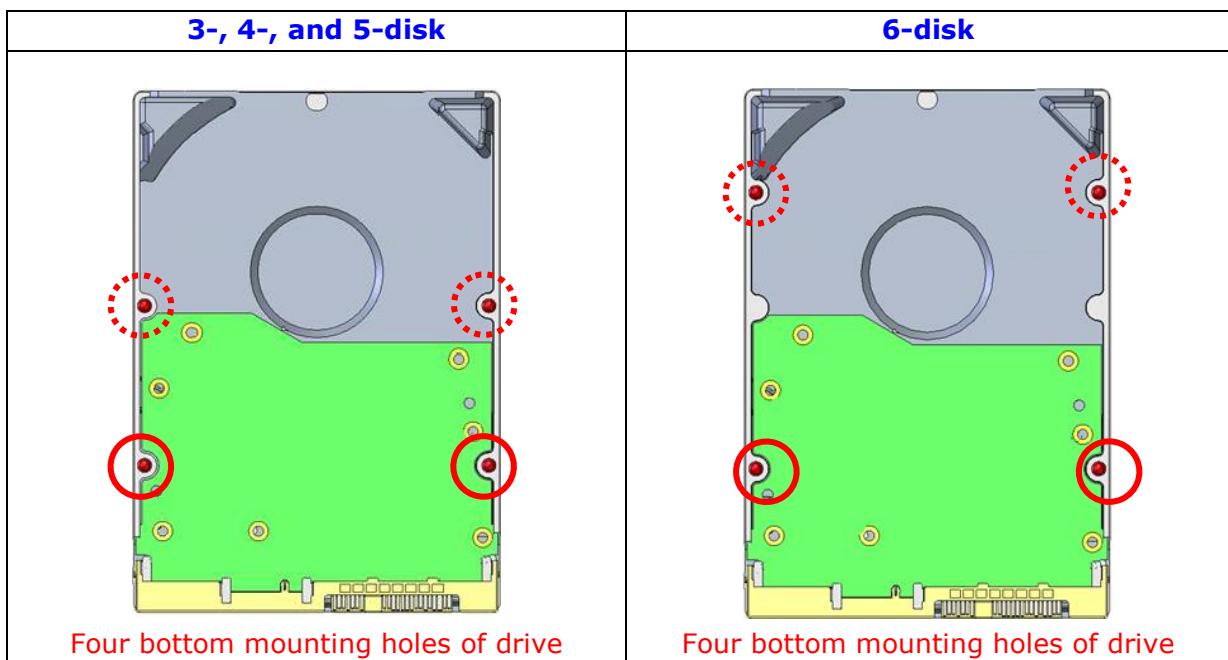

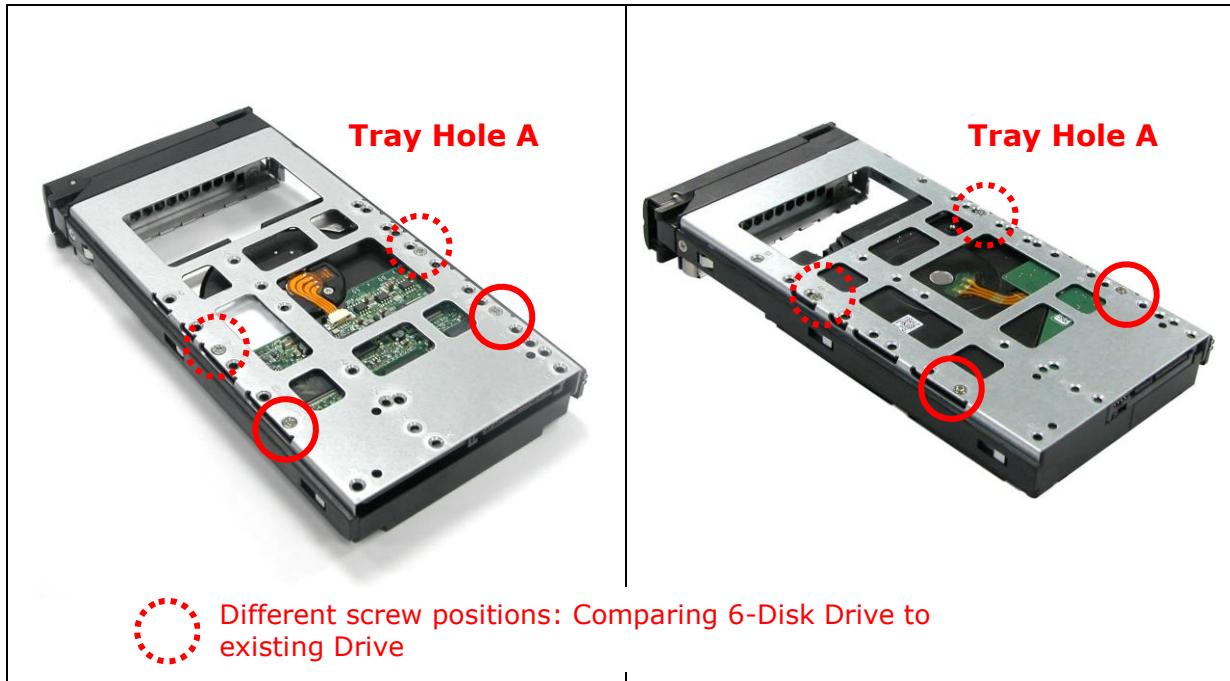

NOTE: All the disk tray holes are labelled accordingly.

5. Slide the tray into a slot.
6. Press the lever in until you hear the latch click into place. The HDD Fault LED will turn green when the subsystem is powered on and HDD is good.
7. If necessary, lock the Disk Tray by turning the Lock Groove.

3.3.2 Installing 2.5" Disk Drive in a Disk Tray

1. Remove an empty disk tray from the subsystem.



2. Place the disk drive in the disk tray. Turn the disk tray upside down. Align the four screw holes of the disk drive in the four *Hole w* of the disk tray. To secure the disk drive into the disk tray, tighten four screws on these holes of the disk tray. Note in the picture below where the screws should be placed in the disk tray holes.



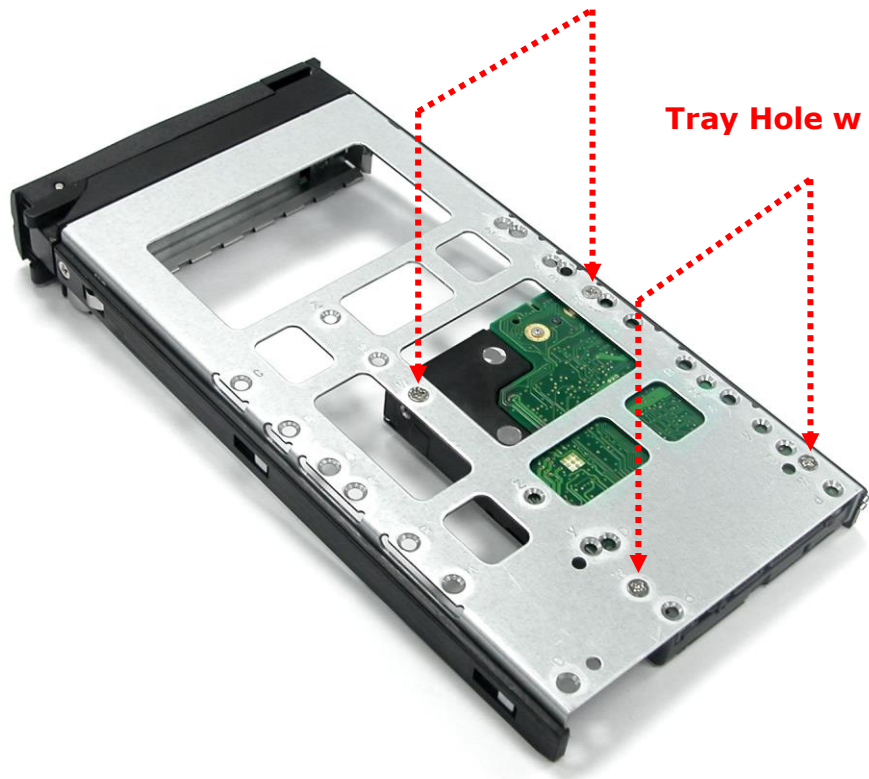

NOTE: All the disk tray holes are labelled accordingly.

3. Slide the tray into a slot.
4. Press the lever in until you hear the latch click into place. The HDD Fault LED will turn green when the subsystem is powered on and HDD is good.

Chapter 4 RAID Configuration Utility Options

Configuration Methods

There are three methods of configuring the RAID controller:

- a. Front panel touch-control buttons
- b. Web browser-based remote RAID management via the R-Link Ethernet port
- c. Telnet connection via the R-Link Ethernet port



NOTE: The RAID subsystem allows you to access using only one method at a time. You cannot use more than one method at the same time.

4.1 Configuration through Telnet



NOTE: This example uses CRT terminal emulation program. You can also use Windows Hyper terminal as another option.

1. To connect to RAID subsystem using Telnet, open Terminal Emulation program (example, CRT 6.1) and start new session, and select Telnet protocol. Click "Next".

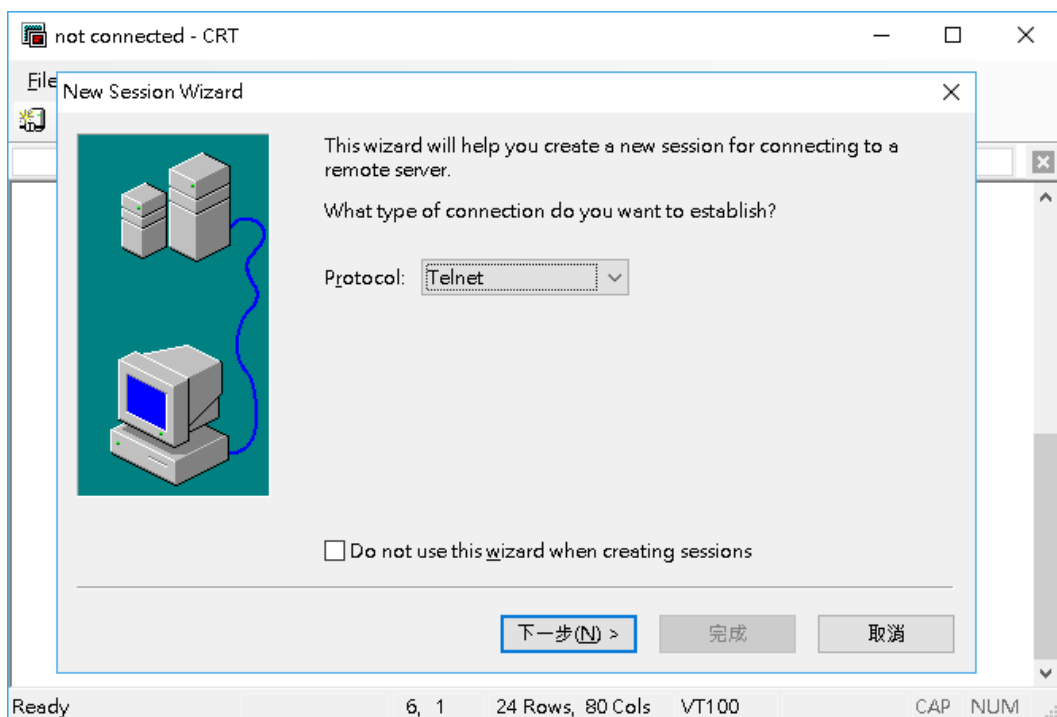

2. Enter the RAID subsystem's IP address. Make sure the PC running the terminal emulation program can connect to the RAID subsystem's IP address. Click "Next".

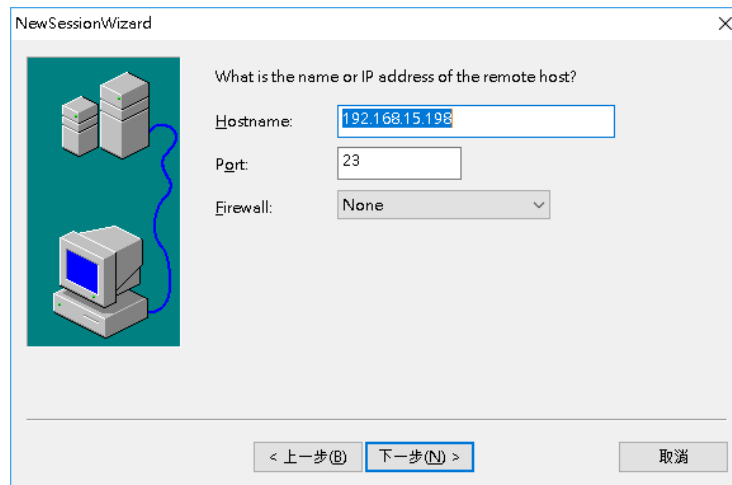

3. Rename the Session name if necessary. Click "Finish".

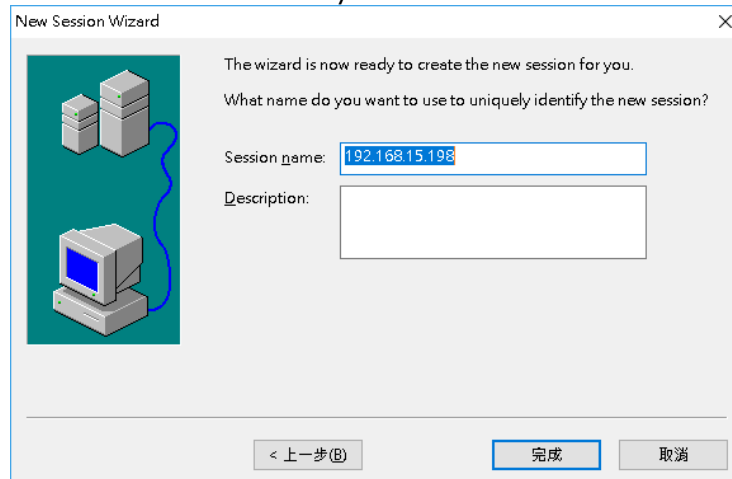

4. Select the Session name and click "Connect".

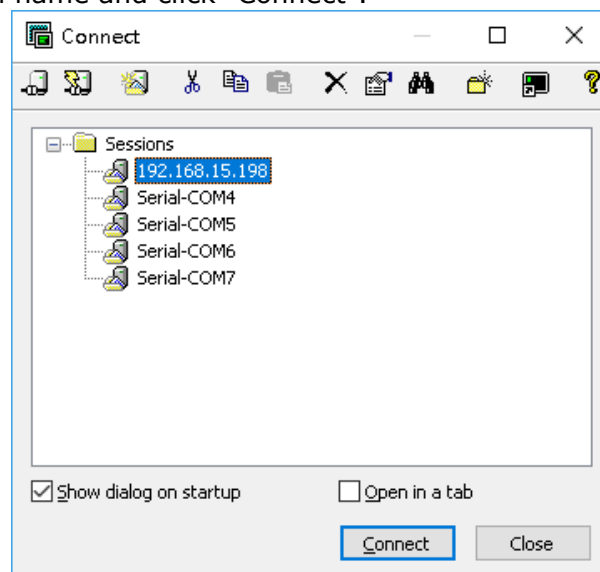

5. After successful connection, the Main Menu will be displayed. Select a menu and the Password box will be shown. Enter password (default is 00000000) to login.

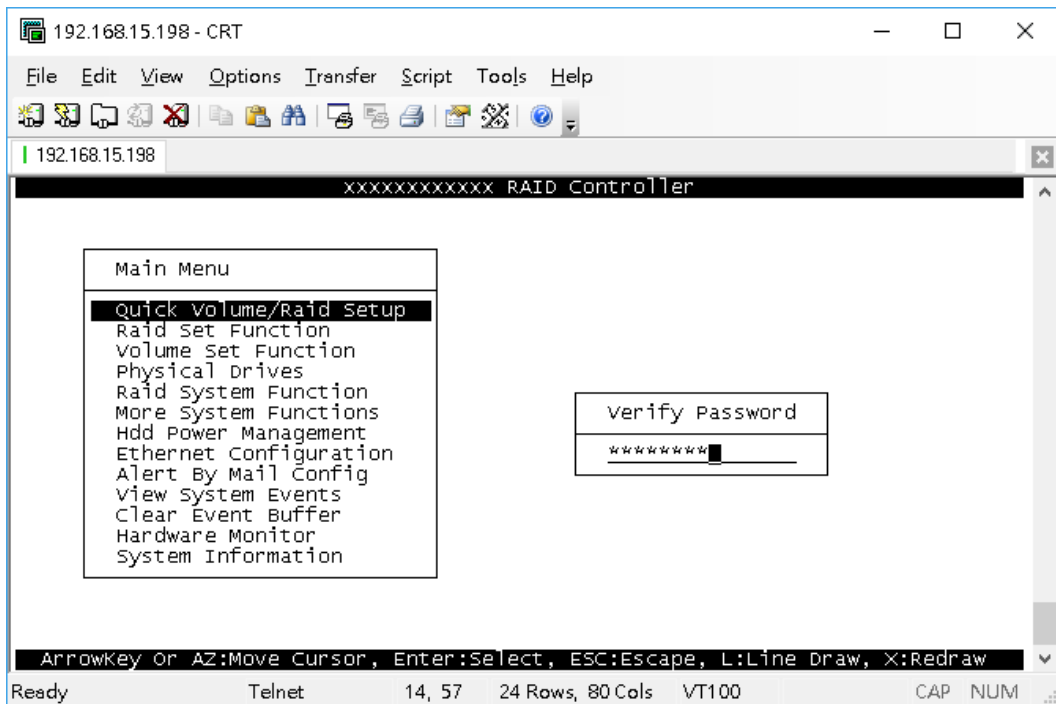

Keyboard Function Key Definitions

- "A" key - to move to the line above
- "Z" key - to move to the next line
- "Enter" key - Submit selection function
- "ESC" key - Return to previous screen
- "L" key - Line draw
- "X" key - Redraw

Main Menu

The main menu shows all function that enables the customer to execute actions by clicking on the appropriate link.

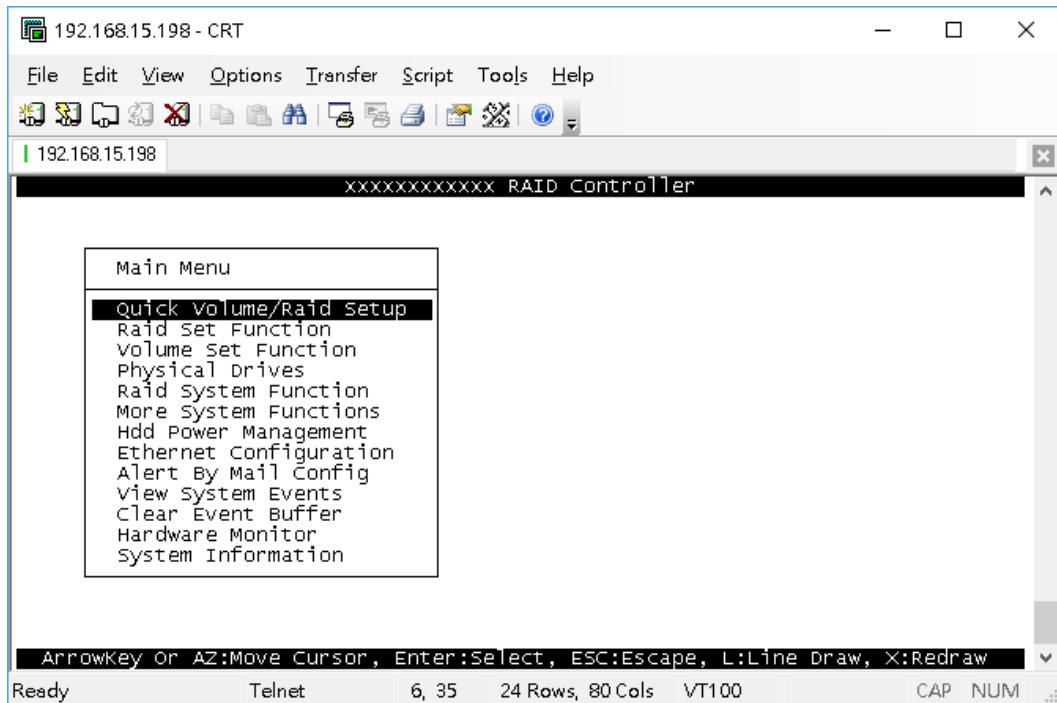

NOTE: The password option allows user to set or clear the RAID subsystem's password protection feature. Once the password has been set, the user can only monitor and configure the RAID subsystem by providing the correct password. The password is used to protect the RAID subsystem from unauthorized access. The controller will check the password only when entering the Main menu from the initial screen. The RAID subsystem will automatically go back to the initial screen when it does not receive any command in twenty seconds. The RAID subsystem's factory default password is set to 00000000.

VT100 terminal configuration Utility Main Menu Options

Select an option and the related information or submenu items display beneath it. The submenus for each item are shown in Section 4.2.1. The configuration utility main menu options are:

Option	Description
Quick Volume And Raid Set Setup	Create a RAID configuration which consists of all physical disks installed
Raid Set Functions	Create a customized Raid Set
Volume Set Functions	Create a customized Volume Set
Physical Drive Functions	View individual disk information
Raid System Functions	Setting the Raid system configurations
More System Functions	Setting the Raid system configurations
Hdd Power Management	Setting the HDD power management configurations
Ethernet Configuration	Setting the Ethernet configurations
Alert By Mail Config	Set the Event Notification functions
Views System Events	Record all system events in the buffer
Clear Event Buffer	Clear all event buffer information
Hardware Monitor	Show all system environment status
System Information	View the controller information



4.2 Configuration through the LCD Panel

All configurations can be performed through the LCD Display front panel function keys, except for the "Firmware update". The LCD provides a system of screens with areas for information, status indication, or menus. The LCD screen displays menu items or other information up to two lines at a time. The RAID controller's factory default password is set to **00000000**.

Function Key Definitions

The four function keys at side of the front panel perform the following functions:



Parts	Function
Up and Down Arrow buttons 	Use the Up or Down arrow keys to go through the information on the LCD screen. This is also used to move between each menu when you configure the subsystem.
Select button 	This is used to enter the option you have selected.
Exit button EXIT	Press this button to return to the previous menu. NOTE: This button can also be used to reset the alarm beeper.

4.2.1 Menu Diagram

The following menu diagram is a summary of the various configurations and setting functions that can be accessed through telnet.

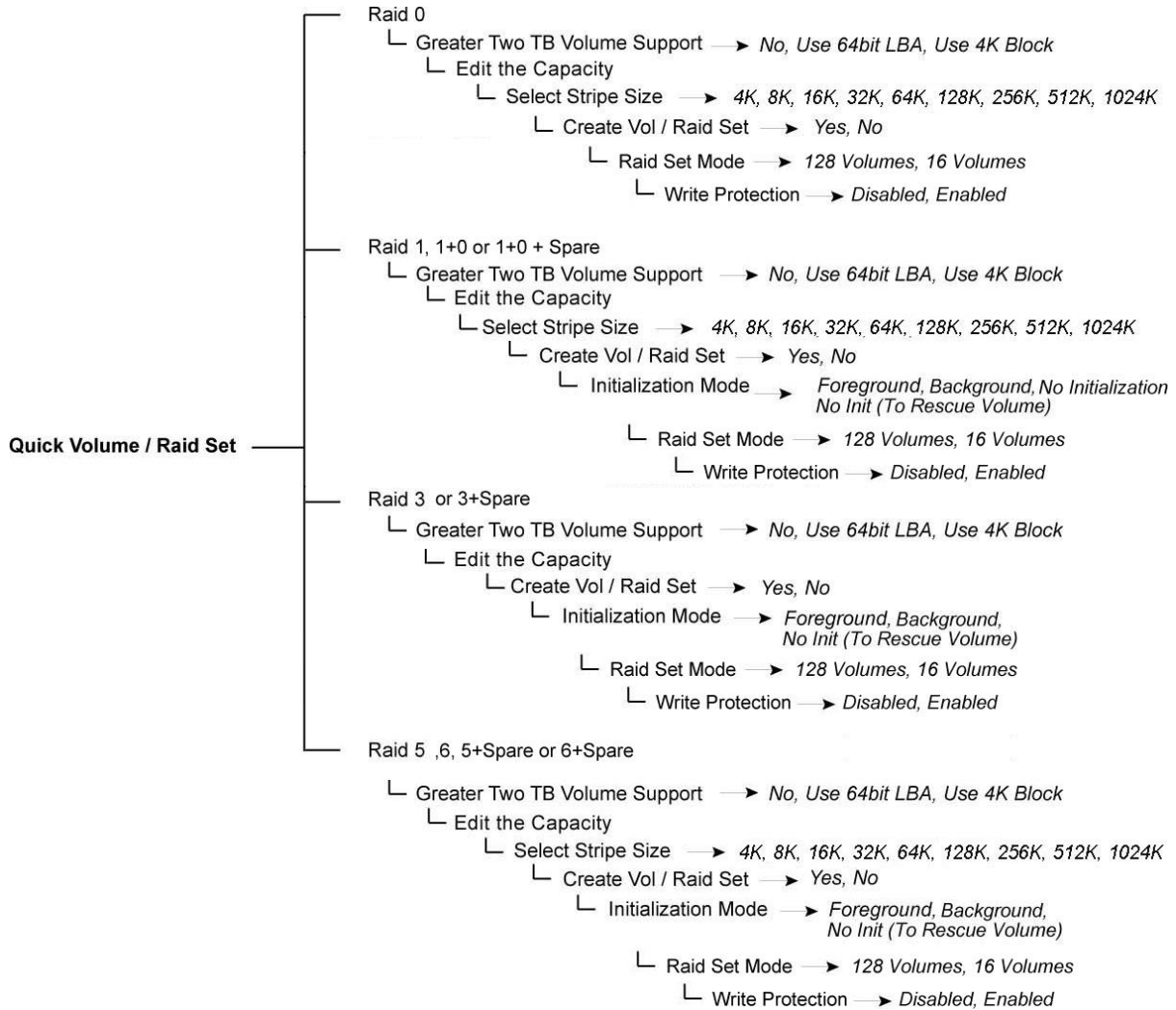

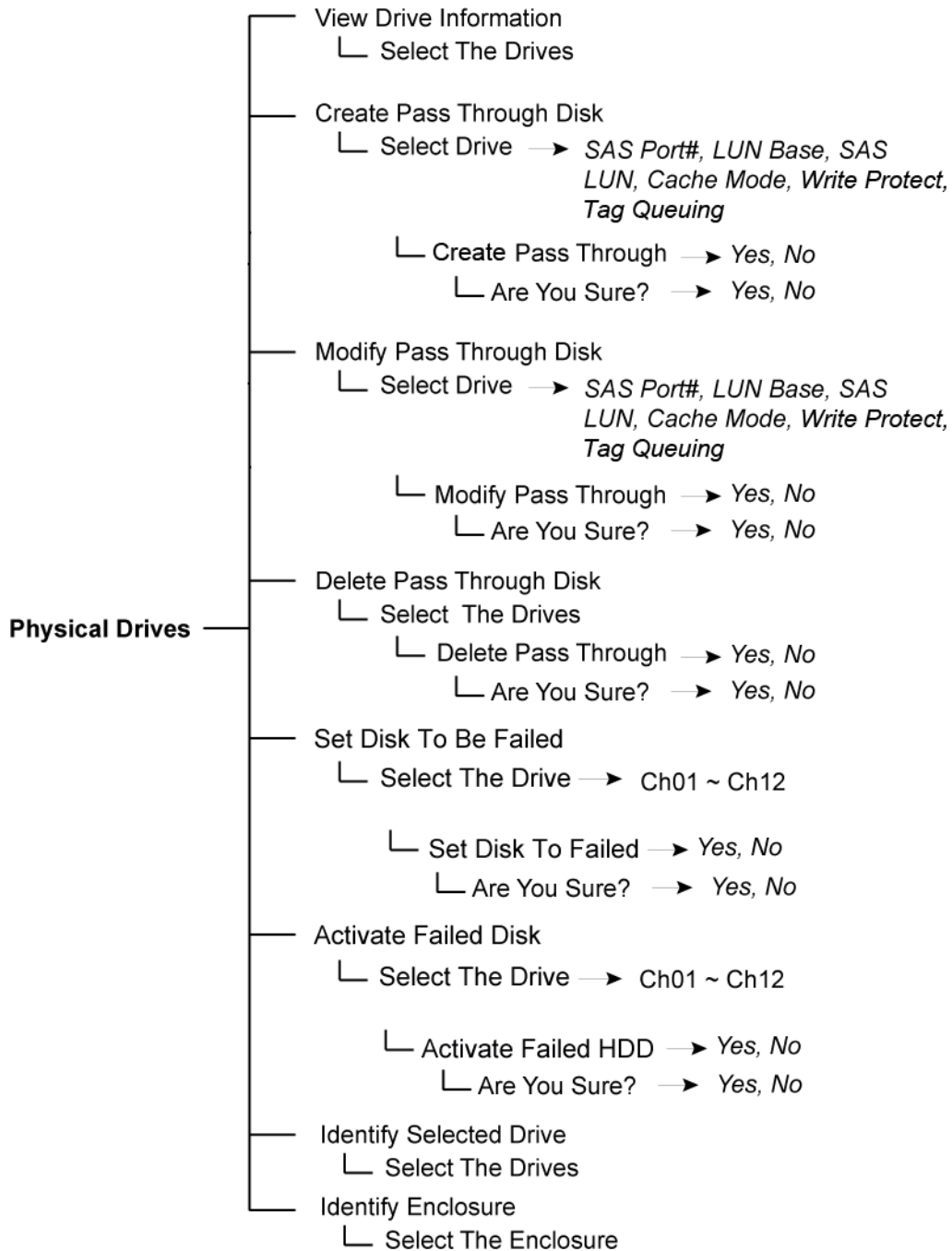

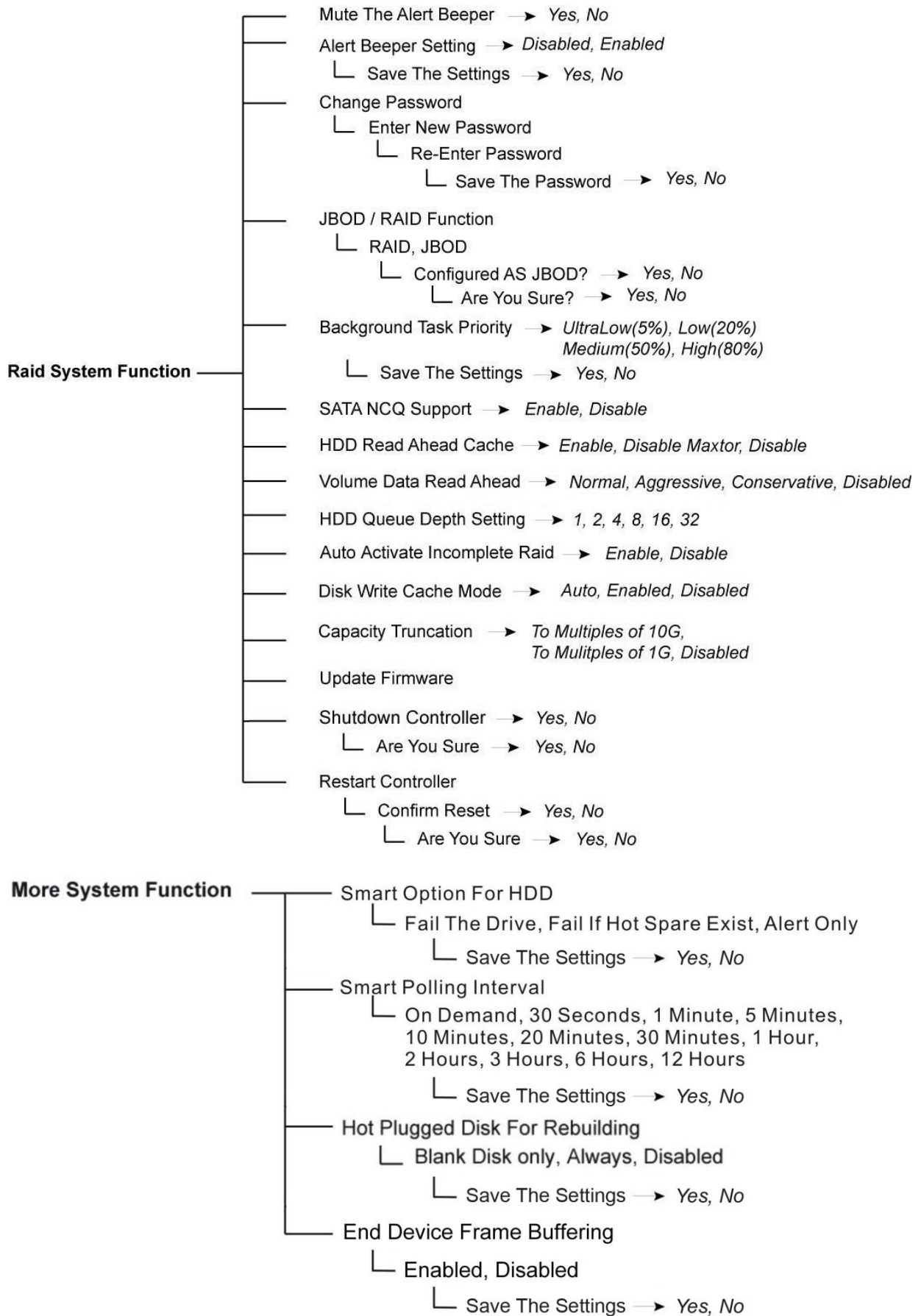

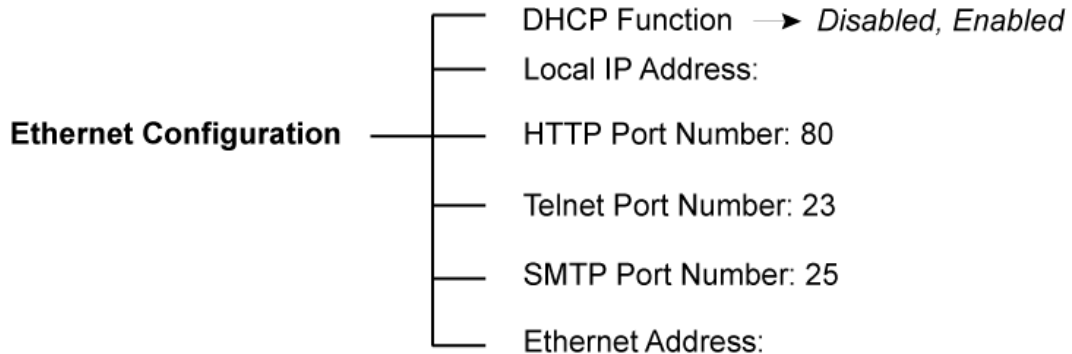
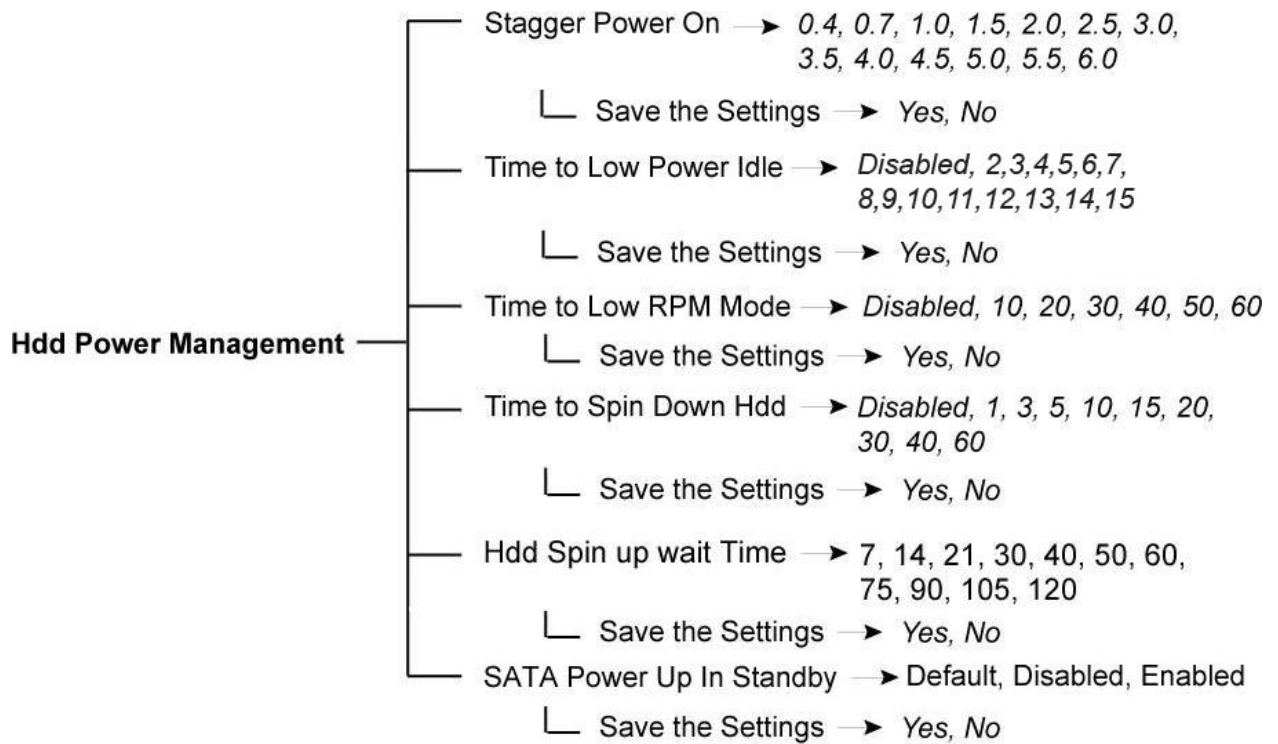

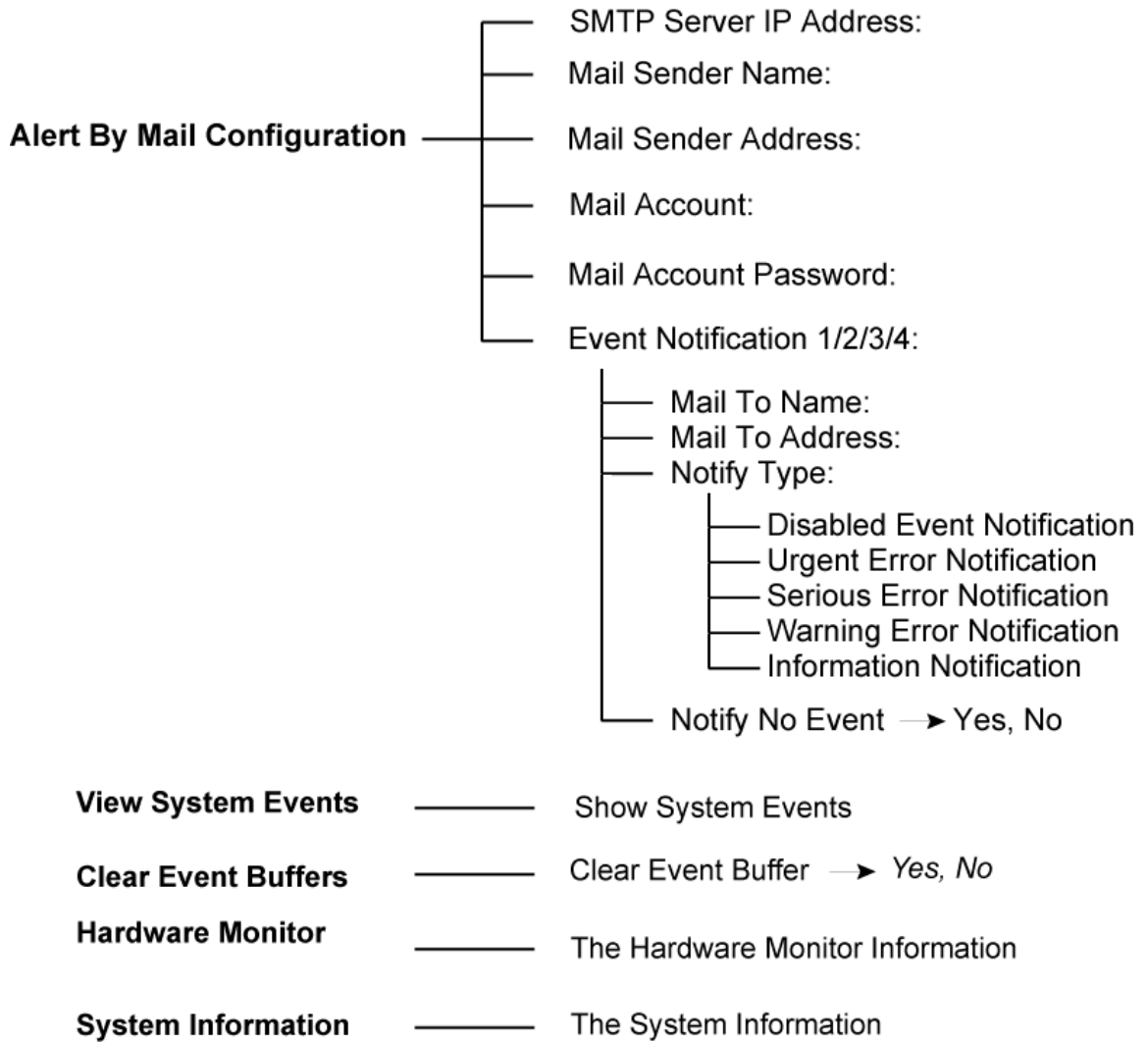

4.3 Configuration through web browser-based proRAID Manager

The RAID subsystem can be remotely configured via R-Link port with proRAID Manager, a web browser-based application. The proRAID Manager can be used to manage all available functions of the RAID controller.

To configure the RAID subsystem from a remote machine, you need to know its IP Address. Launch your web browser from remote machine and enter in the address bar: **http://[IP Address]**.



IMPORTANT! The default IP address of Controller R-Link Port is 192.168.1.100 and subnet mask is 255.255.255.0. DHCP client function is also enabled by default. You can reconfigure the IP Address or disable the DHCP client function through the LCD front panel or terminal "Ethernet Configuration" menu.



NOTE: If DHCP client function is enabled but a DHCP server is unavailable and the IP address is changed, a Controller Restart is necessary. If the DHCP client function is disabled and the IP address is changed, Controller Restart is not needed.

Note that you may need to be logged in as administrator with local admin rights on the remote machine to remotely configure the RAID subsystem. The RAID subsystem controller default User Name is "admin" and the Password is "00000000".

|open all|close all|

- 🔍 Raid System Console
- 📁 Quick Function
- 📁 RAID Set Functions
- 📁 Volume Set Functions
- 📁 Security Functions
- 📁 Physical Drives
- 📁 System Controls
- 📁 Information

■ RaidSet Hierarchy				
RAID Set	Devices	Volume Set(Ch/Lun)	Volume State	Capacity
Raid Set # 000	E#1Slot#1	Volume--VOL#000(0/0,N0_0)	Normal	8000.0GB
	E#1Slot#2			
	E#1Slot#3			
	E#1Slot#4			
	E#1Slot#5			
	E#1Slot#6			
	E#1Slot#7			
	E#1Slot#8			

■ Enclosure# 1 : SAS RAID Subsystem V1.0			
Device	Usage	Capacity	Model
Slot#1(12)	Raid Set # 000	1000.2GB	Hitachi HDE721010SLA330
Slot#2(14)	Raid Set # 000	1000.2GB	Hitachi HDE721010SLA330
Slot#3(19)	Raid Set # 000	1000.2GB	Hitachi HDE721010SLA330
Slot#4(1A)	Raid Set # 000	1000.2GB	Hitachi HDE721010SLA330
Slot#5(15)	Raid Set # 000	1000.2GB	Hitachi HDE721010SLA330
Slot#6(16)	Raid Set # 000	1000.2GB	Hitachi HDE721010SLA330
Slot#7(17)	Raid Set # 000	1000.2GB	Hitachi HDE721010SLA330
Slot#8(18)	Raid Set # 000	1000.2GB	Hitachi HDE721010SLA330
Slot#9	N.A.	N.A.	N.A.
Slot#10	N.A.	N.A.	N.A.

Main Menu

The main menu shows all available function that user can execute by clicking on the appropriate hyperlink.

Individual Category	Description
Quick Function	Create a RAID configuration, which consists of all physical disks installed. The Volume Set Capacity, Raid Level, and Stripe Size can be modified during setup.
Raid Set Functions	Create customized Raid Sets.
Volume Set Functions	Create customized Volume Sets and allow modification of parameters of existing Volume Sets parameter.
Security Functions	Protect Drives with Self-Encrypting Drives (SED) and secure data from unauthorized access or modification.
Physical Drive	Create pass through disks and allow modification of parameters of existing pass through drives. This also provides a function to identify a disk drive.
System Control	For setting the RAID system configurations.
Information	To view the controller and hardware monitor information. The Raid Set hierarchy can also be viewed through the Raid Set Hierarchy item.

Chapter 5 RAID Management

5.1 Quick Function

5.1.1 Quick Create

The number of physical drives in the RAID subsystem determines the RAID levels that can be implemented with the Raid Set. This feature allows user to create a Raid Set associated with exactly one Volume Set. User can change the Raid Level, Capacity, Volume Initialization Mode and Stripe Size. A hot spare can also be created depending upon the existing configuration.

If the Volume Set size is over 2TB, an option "Greater Two TB Volume Support" will be automatically provided in the screen as shown in the example below. There are three options to select: "No", "64bit LBA", and "4K Block").

Quick Create Raid/Volume Set	
Total Number Of Disks	8
Select Raid Level	Raid 5 + Spare
Maximum Capacity Allowed	3000 GB
Select Capacity	3000 GB
Greater Two TB Volume Support	No
Volume Initialization Mode	Foreground Initialization
Select Stripe Size	64 KBytes
RaidSet Mode	Max 128 Volumes
<input type="checkbox"/> Confirm The Operation	
Submit Reset	

Greater Two TB Volume Support:

No: Volume Set capacity is set to maximum 2TB.

64bit LBA: This option use 16 bytes CDB instead of 10 bytes. The maximum volume capacity up to 512TB. For any hard disk drives working in the 4K native mode in the Raid set, the volume set directly sets and exposes 4KB sector size to the operating system. This option works on different OS which supports 16 bytes CDB. Such as: Windows 2003 with SP1 or later / Linux kernel 2.6.x or later.

4K Block: Use this option for Windows OS such as Windows 2000, 2003, or XP. The maximum Volume Set size is 16TB. Just use the Volume as "Basic Disk". Volume can't be used as "Dynamic Disk"; also can't be used in 512Bytes block service program.

Tick on the **Confirm The Operation** option and click on the **Submit** button in the Quick Create screen. The Raid Set and Volume Set will start to initialize.

You can use **RaidSet Hierarchy** feature to view the Volume Set information (Refer to Section 5.6.1).



NOTE: In Quick Create your Raid Set is automatically configured based on the number of disks in your system. Use the Raid Set Function and Volume Set Function if you prefer to customize the Raid Set and Volume Set.



NOTE: In Quick Create, the RAID Level options 30, 50, and 60 are not available. If you need to create Volume Set with RAID Level 30, 50, or 60, use the Create RAID Set function and Create Raid 30/50/60.

5.2 RAID Set Functions

Use the Raid Set Function and Volume Set Function if you prefer to create customized Raid Sets and Volume Sets. User can manually configure and take full control of the Raid Set settings, but it will take a little longer to setup than the Quick Create configuration. Select the Raid Set Function to manually configure the Raid Set for the first time or to delete existing Raid Set and reconfigure a Raid Set.

5.2.1 Create RAID Set

■ Select The Drives For RAID Set		
■ Enclosure#1 : SAS RAID Subsystem V1.0		
<input type="checkbox"/>	Slot#1	500.1GB ATA WDC WD5003ABYX-0
<input type="checkbox"/>	Slot#2	500.1GB ATA WDC WD5003ABYX-0
<input type="checkbox"/>	Slot#3	500.1GB ATA WDC WD5003ABYX-0
<input type="checkbox"/>	Slot#4	500.1GB ATA WDC WD5003ABYX-0
<input type="checkbox"/>	Slot#5	1000.2GB ATA WDC WD10EADS-00M
<input type="checkbox"/>	Slot#6	1000.2GB ATA WDC WD10EADS-00M
<input type="checkbox"/>	Slot#7	1000.2GB ATA WDC WD10EADS-00M
<input type="checkbox"/>	Slot#8	1000.2GB ATA WDC WD10EADS-00P

Raid Set Name: Raid Set # 000
 RaidSet Mode: Max 128 Volumes

Confirm The Operation
 Submit Reset

To create a Raid Set, click on the **Create RAID Set** link. A "Select The Drives For RAID Set" screen is displayed showing the disk drives in the system. Tick the box of each disk drive that will be included in Raid Set to be created. Enter the preferred Raid Set Name (1 to 16 alphanumeric characters) to define a unique identifier for the Raid Set. The default Raid Set name will always appear as **Raid Set # xxx**.

Raid Set Name: Raid Set # 000
 RaidSet Mode: Max 128 Volumes

Confirm The Operation
 Submit Reset

128 volumes is the default mode for SAS RAID controller, the 16 volumes mode is used for support roaming this raidset to SATA RAID controllers. The SATA RAID controller is designed to support up to 16 volumes only. You have to use "Max 16 volumes" on the raidset mode if you plan to roam this raidset between SAS RAID controller and SATA RAID controller.

Tick on the **Confirm The Operation** option and click on the **Submit** button in the screen.

5.2.2 Delete RAID Set

To delete a Raid Set, click on the **Delete RAID Set** link. A "Select The RAID SET To Delete" screen is displayed showing all Raid Sets existing in the system. Select the Raid Set you want to delete in the Select column.

Tick on the **Confirm The Operation** and click on the **Submit** button to process with deletion.

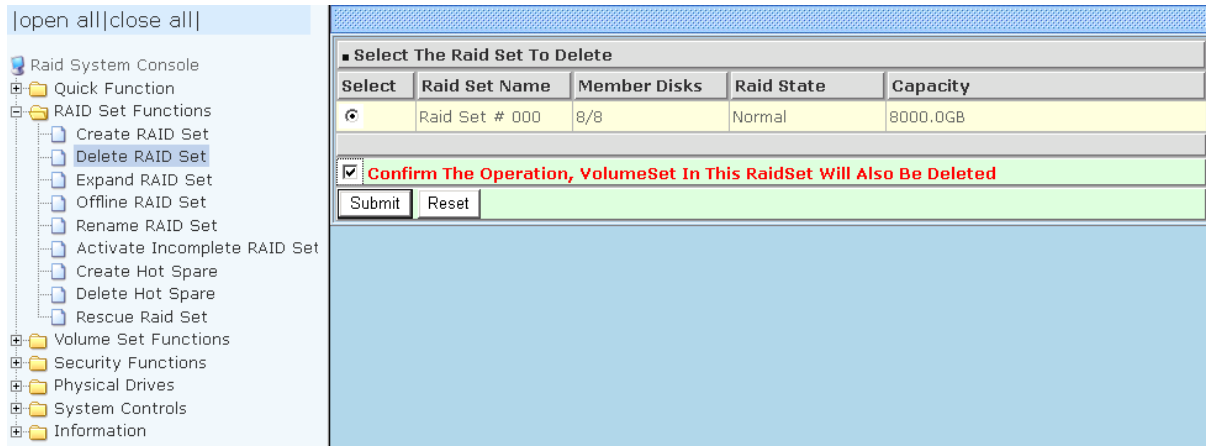

RAID System Console

- Quick Function
- RAID Set Functions
 - Create RAID Set
 - Delete RAID Set
 - Expand RAID Set
 - Offline RAID Set
 - Rename RAID Set
 - Activate Incomplete RAID Set
 - Create Hot Spare
 - Delete Hot Spare
 - Rescue Raid Set
- Volume Set Functions
- Security Functions
- Physical Drives
- System Controls
- Information

Select The Raid Set To Delete

Select	Raid Set Name	Member Disks	Raid State	Capacity
<input checked="" type="radio"/>	Raid Set # 000	8/8	Normal	8000.0GB

Confirm The Operation, VolumeSet In This RaidSet Will Also Be Deleted

Submit Reset



NOTE: You cannot delete a Raid Set containing a Raid 30/50/60 Volume Set. You must delete the Raid 30/50/60 Volume Set first.

5.2.3 Expand RAID Set

Use this option to expand a Raid Set, when one or more disk drives is/are added to the system. This function is active when at least one drive is available.

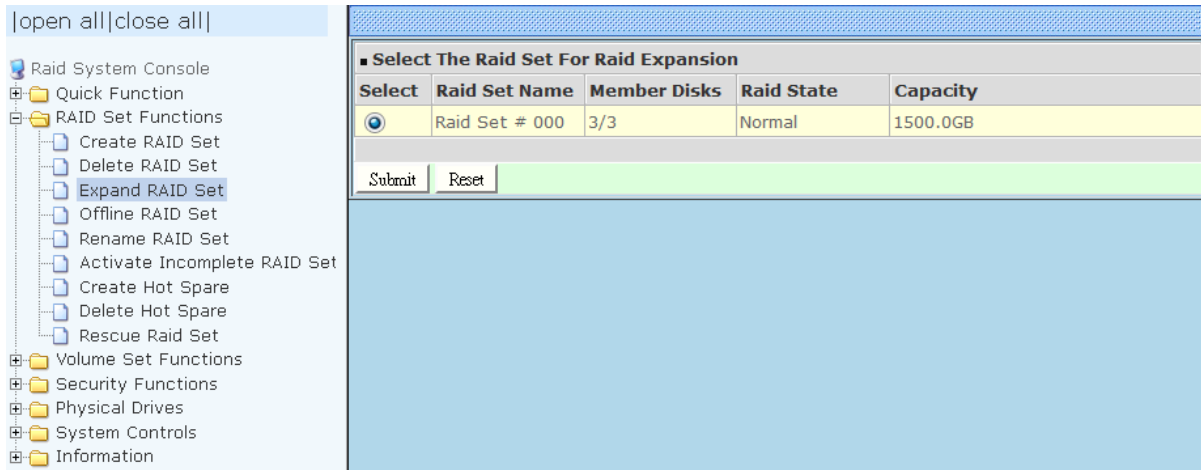

Select	Raid Set Name	Member Disks	Raid State	Capacity
<input checked="" type="radio"/>	Raid Set # 000	3/3	Normal	1500.0GB

To expand a Raid Set, click on the **Expand RAID Set** link. Select the Raid Set which you want to expand.

Tick on the available disk(s) and check **Confirm The Operation**. Click on the **Submit** button to add the selected disk(s) to the Raid Set.



NOTE: Once the Expand Raid Set process has started, user cannot stop it. The process must be completed.



NOTE: If a disk drive fails during Raid Set expansion and a hot spare is available, an auto rebuild operation will occur after the Raid Set expansion is completed.



NOTE: A Raid Set cannot be expanded if it contains a Raid 30/50/60 Volume Set.

|open all|close all|

- Raid System Console
 - Quick Function
 - RAID Set Functions
 - Create RAID Set
 - Delete RAID Set
 - Expand RAID Set
 - Offline RAID Set
 - Rename RAID Set
 - Activate Incomplete RAID Set
 - Create Hot Spare
 - Delete Hot Spare
 - Rescue Raid Set
 - Volume Set Functions
 - Security Functions
 - Physical Drives
 - System Controls
 - Information

■ RAID Expansion on : Raid Set # 000 ; Member Disks : 3

■ Enclosure#1 : SAS RAID Subsystem V1.0

<input checked="" type="checkbox"/>	Slot#4	500.1GB	ATA WDC WD5003ABYX-0
<input type="checkbox"/>	Slot#5	1000.2GB	ATA WDC WD10EADS-00M
<input type="checkbox"/>	Slot#6	1000.2GB	ATA WDC WD10EADS-00M
<input type="checkbox"/>	Slot#7	1000.2GB	ATA WDC WD10EADS-00M
<input type="checkbox"/>	Slot#8	1000.2GB	ATA WDC WD10EADS-00P

Confirm The Operation

Submit Reset

|open all|close all|

- Raid System Console
 - Quick Function
 - RAID Set Functions
 - Create RAID Set
 - Delete RAID Set
 - Expand RAID Set
 - Offline RAID Set
 - Rename RAID Set
 - Activate Incomplete RAID Set
 - Create Hot Spare
 - Delete Hot Spare
 - Rescue Raid Set
 - Volume Set Functions
 - Security Functions
 - Physical Drives
 - System Controls
 - Information

■ Raid Set # 000 : Total Disks = 4, Disks Before Expansion = 3

Volume Name	Raid Level	Stripe Size
Volume---VOL#000	Raid 5	64 KBytes

Change The Volume Attribute During Raid Expansion ?

YES NO Reset

Migration occurs when a disk is added to a Raid Set. Migrating status is displayed in the Raid Set status area of the Raid Set information. Migrating status is also displayed in the Volume Set status area of the Volume Set Information for all Volume Sets under the Raid Set which is migrating.

|open all|close all|

- Raid System Console
 - Quick Function
 - RAID Set Functions
 - Volume Set Functions
 - Security Functions
 - Physical Drives
 - System Controls
 - Information
 - RAID Set Hierarchy
 - SAS Chip Information
 - System Information
 - Hardware Monitor

Stop Auto Refresh

■ RaidSet Hierarchy

RAID Set	Devices	Volume Set(Ch/Lun)	Volume State	Capacity
Raid Set # 000	E#1Slot#1	Volume---VOL#000(0&4/0,N0.0)	Migrating(7.1%)	1000.0GB
	E#1Slot#2			
	E#1Slot#3			
	E#1Slot#4			

■ Enclosure#1 : SAS RAID Subsystem V1.0

Device	Usage	Capacity	Model
Slot#1(A)	Raid Set # 000	500.1GB	ATA WDC WD5003ABYX-0
Slot#2(B)	Raid Set # 000	500.1GB	ATA WDC WD5003ABYX-0
Slot#3(10)	Raid Set # 000	500.1GB	ATA WDC WD5003ABYX-0
Slot#4(11)	Raid Set # 000	500.1GB	ATA WDC WD5003ABYX-0
Slot#5(C)	Free	1000.2GB	ATA WDC WD10EADS-00M
Slot#6(D)	Free	1000.2GB	ATA WDC WD10EADS-00M
Slot#7(E)	Free	1000.2GB	ATA WDC WD10EADS-00M
Slot#8(F)	Free	1000.2GB	ATA WDC WD10EADS-00P
Slot#9	N.A.	N.A.	N.A.



NOTE: Cannot expand Raid Set when contains Raid30/50/60 volume.

|open all|close all|

- Raid System Console
 - Quick Function
 - RAID Set Functions
 - Create RAID Set
 - Delete RAID Set
 - Expand RAID Set
 - Offline RAID Set
 - Rename RAID Set
 - Activate Incomplete RAID Set
 - Create Hot Spare
 - Delete Hot Spare
 - Rescue Raid Set
 - Volume Set Functions
 - Security Functions
 - Physical Drives
 - System Controls
 - Information

Controller Response

Cannot Expand RaidSet Contains Raid30/50/60 Volume

5.2.4 Offline RAID Set

If user wants to offline (and move) a Raid Set while the system is powered on, use the Offline Raid Set function. After completing the function, the HDD state of RAID Set member drives will change to "Offlined" Mode and the HDD Status LEDs will be blinking RED.

To offline a Raid Set, click on the **Offline RAID Set** link. A "Select The RAID SET To Offline" screen is displayed showing all existing Raid Sets in the subsystem. Select the Raid Set which you want to offline in the Select column.

Tick on the **Confirm The Operation**, and then click on the **Submit** button.

Select	Raid Set Name	Member Disks	Raid State	Capacity
<input checked="" type="radio"/>	Raid Set # 000	6/6	Normal	6000.0GB

Confirm The Operation, VolumeSet In This RaidSet Will Also Be Offlined

Submit Reset

RAID Set	Devices	Volume Set(Ch/Lun)	Volume State	Capacity
Enclosure# 1 : SAS RAID Subsystem V1.0				
Device	Usage	Capacity	Model	
Slot#1(12)	Offlined	1000.2GB	Hitachi HDE721010SLA330	
Slot#2(14)	Offlined	1000.2GB	Hitachi HDE721010SLA330	
Slot#3(19)	Offlined	1000.2GB	Hitachi HDE721010SLA330	
Slot#4(1A)	Offlined	1000.2GB	Hitachi HDE721010SLA330	
Slot#5(15)	Offlined	1000.2GB	Hitachi HDE721010SLA330	
Slot#6(16)	Offlined	1000.2GB	Hitachi HDE721010SLA330	
Slot#7(17)	Free	1000.2GB	Hitachi HDE721010SLA330	
Slot#8(18)	Free	1000.2GB	Hitachi HDE721010SLA330	
Slot#9	N.A.	N.A.	N.A.	
Slot#10	N.A.	N.A.	N.A.	

5.2.5 Rename RAID Set

Use this function to rename a RAID Set. Select the **"Rename RAID Set"** under the RAID Set Functions, and then select the RAID Set to rename and click **"Submit"**.

The screenshot shows the RAID System Console interface. On the left is a tree view with 'Rename RAID Set' selected. The main window displays a dialog box titled 'Select The Raid Set To Rename' with a table of RAID sets.

Select	Raid Set Name	Member Disks	Raid State	Capacity
<input checked="" type="checkbox"/>	Raid Set # 000	6/6	Normal	6000.0GB

Below the table are 'Submit' and 'Reset' buttons.

Enter the new name for the RAID Set. Tick the **"Confirm The Operation"** and click **"Submit"**.

The screenshot shows the RAID System Console interface. On the left is a tree view with 'Rename RAID Set' selected. The main window displays a dialog box titled 'Enter The RaidSet Name' with input fields for RAID set details.

Raid Set Name	<input type="text" value="Raid Set #000"/>
Member Disks	6
Min Member Disk Size	1000.0GB

Below the table is a checkbox labeled 'Confirm The Operation' which is currently unchecked. Below the checkbox are 'Submit' and 'Reset' buttons.

5.2.6 Activate Incomplete RAID Set

When Raid Set State is "**Normal**", this means there is no failed disk drive.

■ Raid Set Information	
Raid Set Name	Raid Set # 000
Member Disks	10
Total Raw Capacity	3200.0GB
Free Raw Capacity	756.7GB
Min Member Disk Size	320.0GB
Raid Set Power State	Operating
Raid Set State	Normal

When does "Incomplete" Raid Set State Happens?

If the RAID subsystem is powered off and one disk drive is removed or has failed in power off state, and when the subsystem is powered on, the Raid Set State will change to "**Incomplete**".

■ Raid Set Information	
Raid Set Name	Raid Set # 000
Member Disks	10
Total Raw Capacity	3200.0GB
Free Raw Capacity	3200.0GB
Min Member Disk Size	320.0GB
Raid Set Power State	Operating
Raid Set State	Incomplete

The Volume Set(s) associated with the Raid Set will not be visible and the failed or removed disk will be shown as "**Missing**". At the same time, the subsystem will not detect the Volume Set(s); hence the volume(s) is/are not accessible.

■ RaidSet Hierarchy				
RAID Set	Devices	Volume Set(Ch/Lun)	Volume State	Capacity
Raid Set # 000	E#1SLOT 01			
	E#1SLOT 02			
	Missing			
	E#1SLOT 04			
	E#1SLOT 05			
	E#1SLOT 06			
	E#1SLOT 07			
	E#1SLOT 08			
	E#1SLOT 09			
	E#1SLOT 10			

When can the “Activate Incomplete RAID Set” function be used?

In order to access the Volume Set and corresponding data, use the **Activate Incomplete RAID Set** function to activate the Raid Set. After selecting this function, the Raid State will change to “**Degraded**” state.

To activate the incomplete the Raid Set, click on the **Activate Incomplete RAID Set** link. A “Select The Raid Set To Activate” screen is displayed showing all existing Raid Sets in the subsystem. Select the Raid Set with “**Incomplete**” state which you want to activate in the Select column.

|open all|close all|

- Raid System Console
 - Quick Function
 - RAID Set Functions
 - Create RAID Set
 - Delete RAID Set
 - Expand RAID Set
 - Offline RAID Set
 - Rename RAID Set
 - Activate Incomplete RAID Set**
 - Create Hot Spare
 - Delete Hot Spare
 - Rescue Raid Set
 - Volume Set Functions
 - Security Functions
 - Physical Drives
 - System Controls
 - Information

■ Select The Raid Set To Activate

Select	Raid Set Name	Member Disks	Raid State	Capacity
<input checked="" type="radio"/>	Raid Set # 000	9/10	Incomplete	3200.0GB

Click on the **Submit** button to activate the Raid Set. The Volume Set(s) associated with the Raid Set will become accessible in “**Degraded**” mode.

|open all|close all|

- Raid System Console
 - Quick Function
 - RAID Set Functions
 - Volume Set Functions
 - Security Functions
 - Physical Drives
 - System Controls
 - Information
 - RAID Set Hierarchy**
 - SAS Chip Information
 - System Information
 - Hardware Monitor

■ RAID Set Hierarchy

RAID Set	Devices	Volume Set(Ch/Lun)	Volume State	Capacity
Raid Set # 000	E#1Slot#1	Volume---VOL#000(0/0,N0.0)	Degraded	2199.0GB
	E#1Slot#2			
	E#1Slot#3			
	E#1Slot#4			
	E#1Slot#5			
	Failed			

■ Enclosure#1 : SAS RAID Subsystem V1.0

Device	Usage	Capacity	Model
Slot#1(12)	Raid Set # 000	1000.2GB	Hitachi HDE721010SLA330
Slot#2(14)	Raid Set # 000	1000.2GB	Hitachi HDE721010SLA330
Slot#3(18)	Raid Set # 000	1000.2GB	Hitachi HDE721010SLA330
Slot#4(19)	Raid Set # 000	1000.2GB	Hitachi HDE721010SLA330
Slot#5(15)	Raid Set # 000	1000.2GB	Hitachi HDE721010SLA330



NOTE: The “Activate Incomplete RAID Set” function is only used when Raid Set State is “Incomplete”. It cannot be used when Raid Set configuration is lost. In case Raid Set configuration is lost, contact your vendor for support.

5.2.7 Create Hot Spare

The Create Hot Spare option gives you the ability to define a global hot spare.

When you choose the **Create Hot Spare** option in the Raid Set Function, all unused (non Raid Set member) disk drives in the subsystem appear. Select the target disk drive by clicking on the appropriate check box. Select the Hot Spare Type. Tick on the **Confirm The Operation** and click on the **Submit** button to create hot spare drive(s).

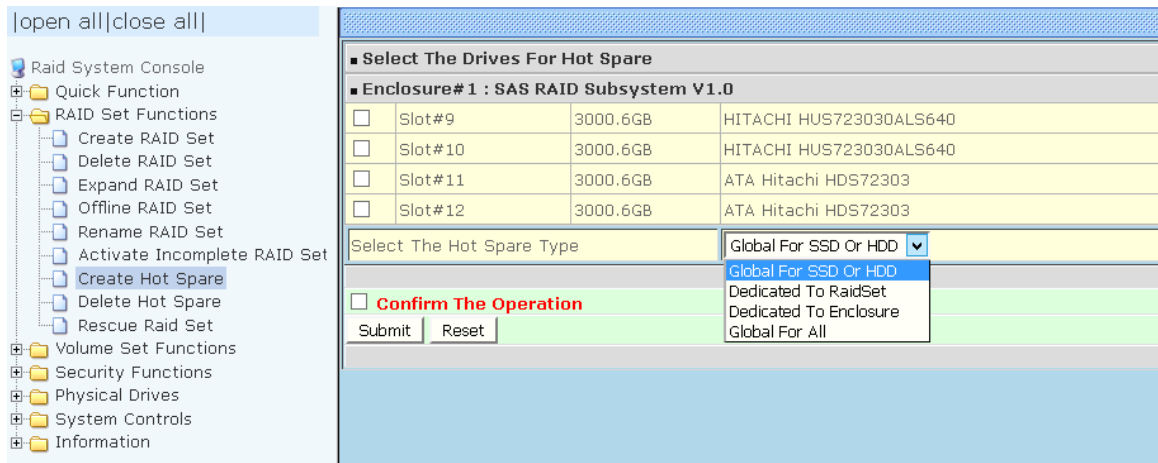

Hot Spare Type	Description
Global For SSD or HDD	If you are mixing SSD and HDD in a system, the Hot Spare SSD is a hot spare only to the SSD. This is to prevent possible drops in performance due to HDD using.
Global Hot Spare	The Hot Spare disk is a hot spare on all enclosures connected in daisy chain. It can replace any failed disk in any enclosure.
Dedicated to RaidSet	The Hot Spare disk is a hot spare dedicated only to the RaidSet where it is assigned. It can replace any failed disk in the RaidSet where it is assigned.
Dedicated to Enclosure	The Hot Spare disk is a hot spare dedicated only to the enclosure where it is located. It can replace any failed disk on the enclosure where it is located. NOTE: When the Raid Set status is in Degraded state, this option will not work.



NOTE: The capacity of the hot spare disk(s) must be equal to or greater than the smallest hard disk size in the subsystem so that it/they can replace any failed disk drive.



NOTE: The Hot Spare Type can also be viewed by clicking on RAID Set Hierarchy in the Information menu.

The hot spare type will be indicated in the "Model" area of the "RAID Set Hierarchy" screen. Select the **RAID Set Hierarchy** link from the **Information** menu to display the RAID Set Hierarchy screen.

open all|close all|

- Raid System Console
- Quick Function
- RAID Set Functions
- Volume Set Functions
- Security Functions
- Physical Drives
- System Controls
- Information
 - RAID Set Hierarchy**
 - SAS Chip Information
 - System Information
 - Hardware Monitor

■ RAID Set Hierarchy				
RAID Set	Devices	Volume Set(Ch/Lun)	Volume State	Capacity
Raid Set # 000	E#1Slot#1	Volume---VOL#000(08-4/0,N00,0)	Normal	300.0GB
	E#1Slot#2			
	E#1Slot#3			

■ Enclosure# 1 : SAS RAID Subsystem V1.0			
Device	Usage	Capacity	Model
Slot#1(A)	Raid Set # 000	450.1GB	TOSHIBA AL14SEB045N
Slot#2(B)	Raid Set # 000	300.0GB	TOSHIBA AL14SEB030N
Slot#3(14)	Raid Set # 000	600.1GB	TOSHIBA AL14SEB060N
Slot#4(15)	Hot Spare	600.1GB	TOSHIBA AL14SEB060N [Global-All]
Slot#5(C)	Hot Spare	120.0GB	LITEONIT LAT-128M3S [Global-SSD]
Slot#6(D)	Hot Spare	300.0GB	TOSHIBA AL14SEB030N [Global-HDD]
Slot#7(12)	Hot Spare	600.1GB	TOSHIBA AL14SEB060N [Raid Set # 000]
Slot#8(13)	Hot Spare	450.1GB	TOSHIBA AL14SEB045N [Enclosure]

5.2.8 Delete Hot Spare

Select the target Hot Spare disk(s) to delete by clicking on the appropriate check box. Tick on the **Confirm The Operation**, and click on the **Submit** button in the screen to delete the hot spare(s).

open all|close all|

- Raid System Console
- Quick Function
- RAID Set Functions
 - Create RAID Set
 - Delete RAID Set
 - Expand RAID Set
 - Offline RAID Set
 - Rename RAID Set
 - Activate Incomplete RAID Set
 - Create Hot Spare
 - Delete Hot Spare**
 - Rescue Raid Set
- Volume Set Functions
- Security Functions
- Physical Drives
- System Controls
- Information

■ Select The Hot Spare Drive To Delete			
■ Enclosure# 1 : SAS RAID Subsystem V1.0			
<input checked="" type="checkbox"/>	Slot#8	1000.2GB	Hitachi HDE721010SLA330 [Global]

<input checked="" type="checkbox"/> Confirm The Operation
Submit Reset

5.2.9 Rescue Raid Set

If you need to recover missing Raid Set configuration using the “Rescue Raid Set” function, please contact your vendor’s support engineer for assistance.

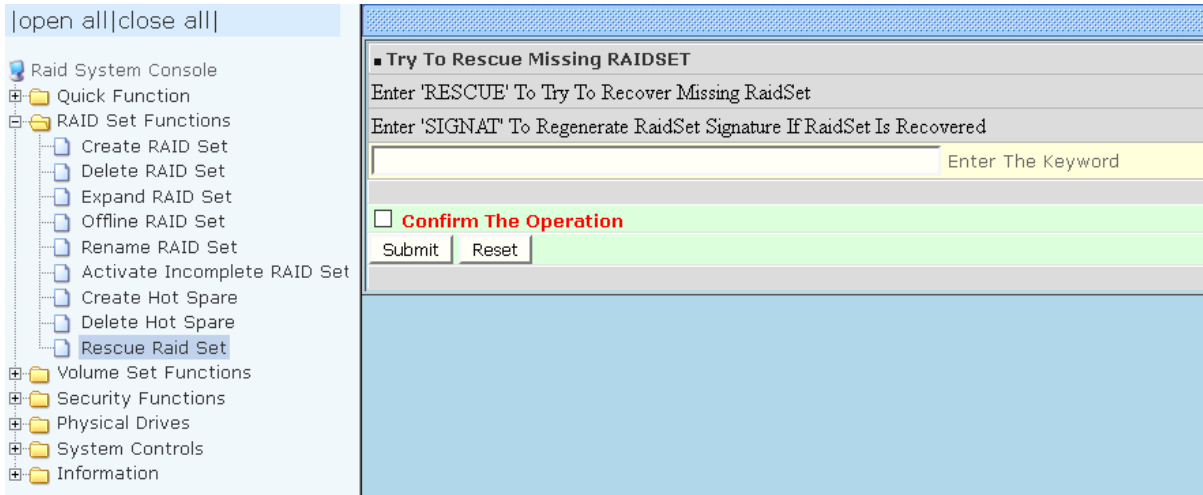

5.3 Volume Set Function

Volume Set is seen by the host system as a single logical device. It is organized in a RAID level with one or more physical disks. RAID level refers to the level of data performance and protection of a Volume Set. A Volume Set capacity can consume all or a portion of the raw capacity available in a Raid Set. Multiple

Volume Sets can exist on a group of disks in a Raid Set. Additional Volume Sets created in a specified Raid Set will reside on all the physical disks in the Raid Set. Thus each Volume Set on the Raid Set will have its data spread evenly across all the disks in the Raid Set.

5.3.1 Create Volume Set

The following are the Volume Set features:

1. Volume sets of different RAID levels may coexist on the same Raid Set.
2. Up to 128 Volume Sets in a Raid Set can be created by the RAID controller.
3. The maximum addressable size of a single volume set is not limited to 2TB, because the controller is capable of 64-bit LBA mode. However the operating system itself may not be capable of addressing more than 2TB.

To create Volume Set from a Raid Set, expand the Volume Set Functions in the main menu and click on the **Create Volume Set** link. The **Select The Raid Set To Create On It** screen will show all existing Raid Sets. Tick on the Raid Set where you want to create the Volume Set and then click on the **Submit** button.

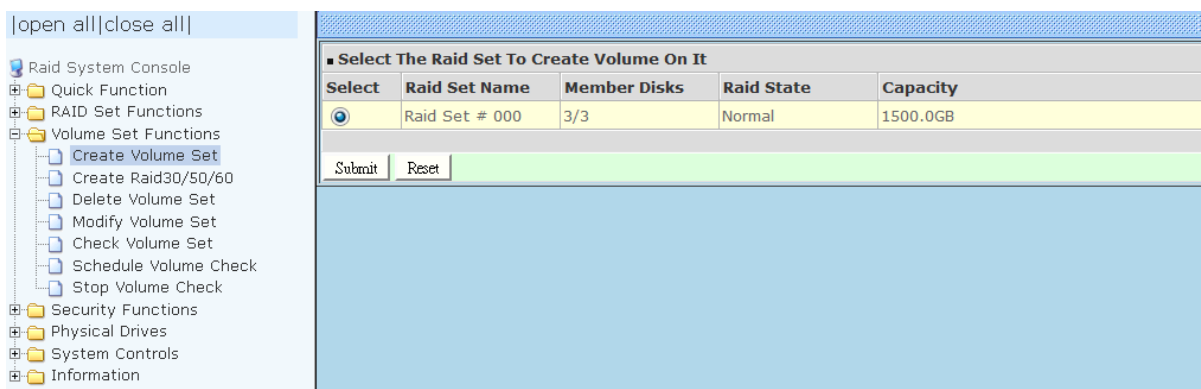

The Volume Set setup screen allows user to configure the Volume Name, Capacity, RAID level, Initialization Mode, Stripe Size, Cache Mode, Tagged Command Queuing, Controller #1 SAS Port Mapping, Controller #2 SAS Port Mapping, LUN Base:LUN, and Volume To Be Created.

Enter The Volume Attribute	
Volume Name	Volume---VOL#000
Member Disks	3
Volume Raid Level	Raid 5
Max Capacity Allowed	2400 GB
Select Volume Capacity	2400 GB
Greater Two TB Volume Support	No
Volume Initialization Mode	Foreground Initialization
Volume Stripe Size	64 KBytes
Volume Cache Mode	Write Back
Volume Write Protection	Disabled
Tagged Command Queuing	Enabled
Controller#1 SAS Port Mapping	<input checked="" type="checkbox"/> Port0 <input type="checkbox"/> Port1
Controller#2 SAS Port Mapping	<input checked="" type="checkbox"/> Port2 <input type="checkbox"/> Port3
LUN Base:LUN	0 : 0
Volumes To Be Created	1
<input type="checkbox"/> Confirm The Operation	
Submit Reset	

Volume Name:

The default Volume Set name will appear as "Volume---VOL#XXX". You can rename the Volume Set name provided it does not exceed the 16 characters limit.

Raid Level:

Set the RAID level for the Volume Set. Click the down-arrow in the drop-down list. The available RAID levels for the current Volume Set are displayed. Select the preferred RAID level.

Capacity:

The maximum Volume Set size is displayed by default. If necessary, change the Volume Set size appropriate for your application.

Greater Two TB Volume Support:

If the Volume Set size is over 2TB, an option "Greater Two TB Volume Support" will be automatically provided in the screen as shown in the example above. There are three options to select: "No", "64bit LBA", and "4K Block").

No: Volume Set size is set to maximum 2TB limitation.

64bit LBA: This option use 16 bytes CDB instead of 10 bytes. The maximum volume capacity up to 512TB. For any hard disk drives working in the 4K native mode in the Raid set, the volume set directly sets and exposes 4KB sector size to the operating system. This option works on different OS which supports 16 bytes CDB. Such as: Windows 2003 with SP1 or later / Linux kernel 2.6.x or later.

4K Block: Use this option for Windows OS such as Windows 2000, 2003, or XP. The maximum Volume Set size is 16TB. Just use the Volume as "Basic Disk". Volume can't be used as "Dynamic Disk"; also can't be used in 512Bytes block service program.

Initialization Mode:

Set the Initialization Mode for the Volume Set. Initialization in Foreground mode is completed faster but must be completed before Volume Set becomes accessible. Background mode makes the Volume Set instantly available but the initialization process takes longer. No Init (To Rescue Volume) is used to create a Volume Set without initialization; normally used to recreate Volume Set configuration to recover data.

Stripe Size:

This parameter sets the size of the stripe written to each disk in a RAID 0, 1, 10, 5 or 6 Volume Set. You can set the stripe size to 4 KB, 8 KB, 16 KB, 32 KB, 64 KB, 128 KB, 256 KB, 512 KB, or 1024 KB.

A larger stripe size produces better-read performance, especially if your computer does mostly sequential reads. However, if you are sure that your computer does random reads more often, select a small stripe size.



NOTE Stripe Size in RAID level 3 can't be modified.

Cache Mode:

The RAID subsystem supports two types of write caching: Write-Through and Write-Back.

Write-Through: data are both written to the cache and the disk(s) before the write I/O is acknowledged as complete.

Write-Back: when data is written to cache, the I/O is acknowledged as complete, and some time later, the cached data is written or flushed to the disk(s). This provides better performance but requires a battery module support for the cache memory, or a UPS for the subsystem.

White Protection:

The RAID Subsystem supports write protection: Disabled and Enabled.

Tagged Command Queuing:

When this option is enabled, it enhances the overall system performance under multi-tasking operating systems by reordering tasks or requests in the command queue of the RAID system. This function should normally remain enabled.

Controller #1 SAS Port Mapping: Controller #1 has two 12Gbps SAS Host Channels A and B (Ports 0 and 1). Select the SAS Port where to map the LUN (volume Set).

Controller #2 SAS Port Mapping: Controller #2 has two 12Gbps SAS Host Channels A and B (Ports 2 and 3). Select the SAS Port where to map the LUN (volume Set).



NOTE: The default Port mapping is Port 0 and 2 and provides dual path to LUN on both controllers. MPIO must be setup in host/server.

NOTE: If LUN is mapped to a SAS Port on one controller only (example: Port 0), the cache mirror will be disabled.

NOTE: If LUN is not mapped to any SAS Port, then LUN is disabled.

LUN Base/LUN:

LUN Base: The base LUN number. Each LUN Base supports 8 LUNs.

LUN: Each Volume Set must be assigned a unique LUN ID number. A SAS Port can connect up to 128 devices (LUN ID: 0 to 127). Select the LUN ID for the Volume Set.

Volumes To Be Created: Use this option to create several Volume Sets with the same Volume Set attributes. Up to 128 Volume Sets can be created.

5.3.2 Create Raid 30/50/60

To create a Raid30/50/60 Volume Set, move the mouse cursor to the main menu and click on the **Create Raid30/50/60** link. The **Select Multiple RaidSet For Raid30/50/60** screen will show all Raid Sets. Tick on the Raid Sets that you want to include in the creation and then click on the **Submit** button.



NOTE: Maximum of 8 Raid Sets is supported. All Raid Sets must contain the same number of disk drives.

|open all|close all|

- Raid System Console
- Quick Function
- RAID Set Functions
- Volume Set Functions
 - Create Volume Set
 - Create Raid30/50/60**
 - Delete Volume Set
 - Modify Volume Set
 - Check Volume Set
 - Schedule Volume Check
 - Stop Volume Check
- Security Functions
- Physical Drives
- System Controls
- Information

Select Multiple RaidSet For Raid30/50/60 (Max 8 RaidSet Supported)				
<input checked="" type="checkbox"/>	Raid Set # 000	3	300.0GB	1800.0GB
<input checked="" type="checkbox"/>	Raid Set # 001	3	1800.0GB	1800.0GB

Submit Reset

Configure the Volume Set attributes (refer to previous section for the Volume Set attributes). When done, tick **Confirm The Operation** and click on **Submit** button.

|open all|close all|

- Raid System Console
- Quick Function
- RAID Set Functions
- Volume Set Functions
 - Create Volume Set
 - Create Raid30/50/60**
 - Delete Volume Set
 - Modify Volume Set
 - Check Volume Set
 - Schedule Volume Check
 - Stop Volume Check
- Security Functions
- Physical Drives
- System Controls
- Information

Enter The Volume Attribute	
Volume Name	Volume--VOL#000
Member Disks	2x3
Volume Raid Level	50
Max Capacity Allowed	2400.0 GB
Select Volume Capacity	2400.0 GB
Greater Two TB Volume Support	No
Volume Initialization Mode	Foreground Initialization
Volume Stripe Size	64 KBytes
Volume Cache Mode	Write Back
Volume Write Protection	Disabled
Tagged Command Queuing	Enabled
Controller#1 SAS Port Mapping	<input checked="" type="checkbox"/> Port0 <input type="checkbox"/> Port1
Controller#2 SAS Port Mapping	<input checked="" type="checkbox"/> Port2 <input type="checkbox"/> Port3
LUN Base:LUN	0 : 0
Volumes To Be Created	1

Confirm The Operation

Submit Reset



NOTE: Refer to Section 5.3.1 Create Volume Set for detailed information about the Volume Set settings.

5.3.3 Delete Volume Set

To delete a Volume Set, select the Volume Set Functions in the main menu and click on the **Delete Volume Set** link. The **Select The Volume Set To Delete** screen will show all available Raid Sets. Tick on a Raid Set and check the **Confirm The Operation** option and then click on the **Submit** button to show all Volume Sets in the selected Raid Set. Tick on a Volume Set and check the **Confirm The Operation** option. Click on the **Submit** button to delete the Volume Set.



The screenshot displays the RAID System Console interface. On the left, a tree view shows the navigation menu with 'Delete Volume Set' highlighted. The main area shows the 'Select The Volume Set To Delete' screen, which includes a table of available RAID sets and a confirmation section.

Select	Volume Set Name	On Raid Set	Capacity
<input type="checkbox"/>	Volume---VOL#000	Raid Set # 000	15000.0GB
<input type="checkbox"/>	Volume---VOL#001	Raid Set # 000	5000.0GB

Confirm The Operation

Submit Reset

5.3.4 Modify Volume Set

Use this function to modify Volume Set configuration.

1. Click on the **Modify Volume Set** link.

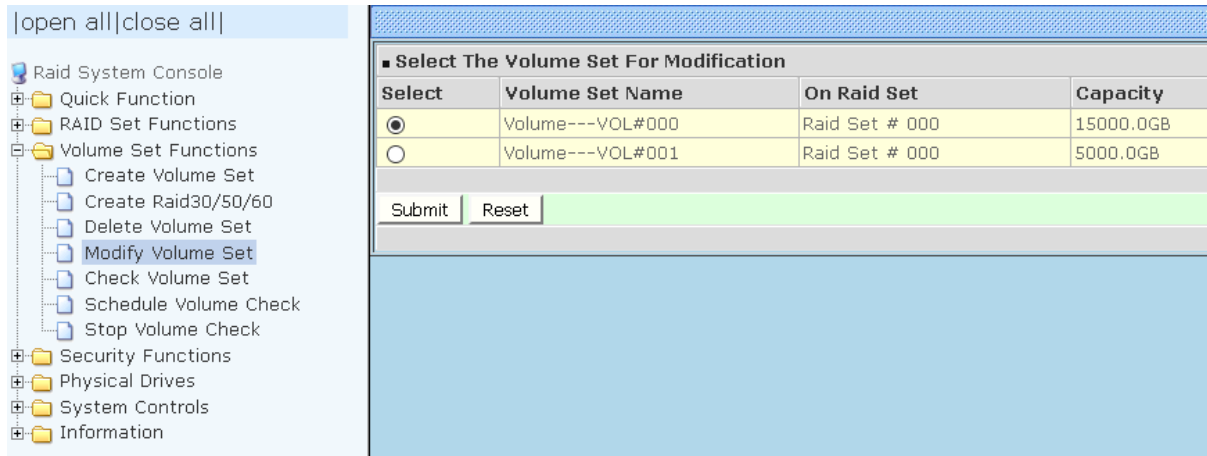

2. Tick from the list the Volume Set you want to modify. Click on the **Submit** button.

The following screen appears.

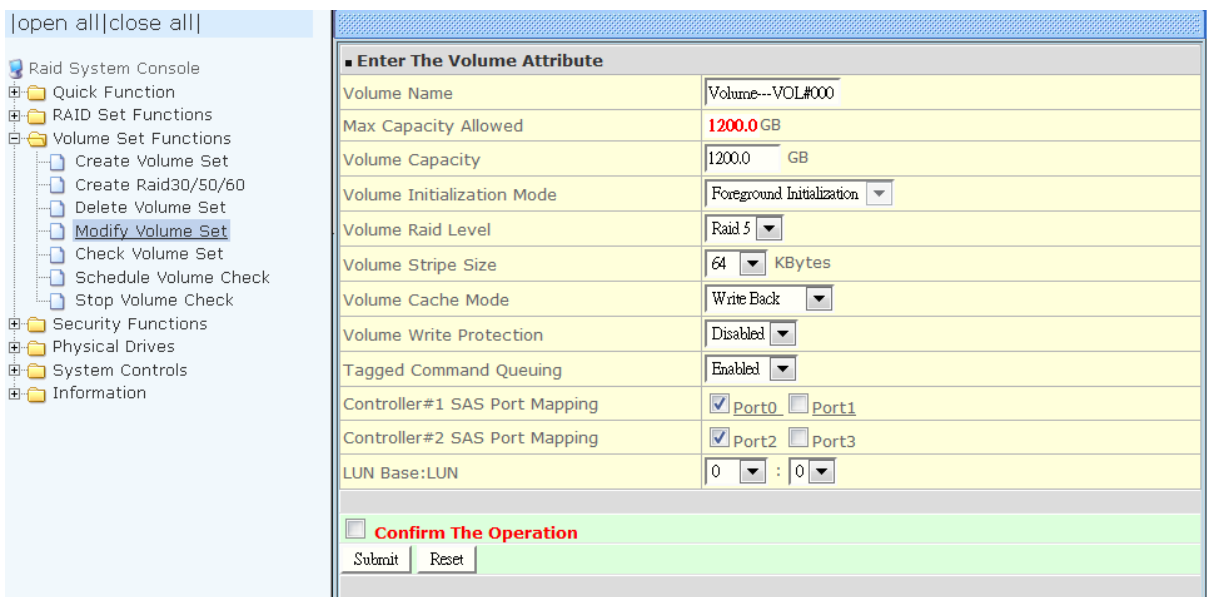

To modify Volume Set attribute values, select an attribute item and click on the attribute value. After completing the modification, tick on the **Confirm The Operation** option and click on the **Submit** button to save the changes.

5.3.4.1 Volume Set Expansion

Volume Capacity (Logical Volume Concatenation Plus Re-stripe)

Use the Expand Raid Set function to expand a Raid Set when a disk is added to your subsystem. (Refer to Section 5.2.3)

The expanded capacity can be used to enlarge the Volume Set size or create another Volume Set. Use the Modify Volume Set function to expand the Volume Set capacity. Select the Volume Set and move the cursor to the **Volume Set Capacity** item and enter the capacity size.

Tick on the **Confirm The Operation** and click on the **Submit** button to complete the action. The Volume Set starts to expand.



NOTE: The Volume Set capacity of RAID30/50/60 cannot be expanded.

Enter The Volume Attribute	
Volume Name	Volume--VOL#000
Max Capacity Allowed	1200.0 GB
Volume Capacity	1200.0 GB
Volume Initialization Mode	Foreground Initialization
Volume Raid Level	Raid 5
Volume Stripe Size	64 KBytes
Volume Cache Mode	Write Back
Volume Write Protection	Disabled
Tagged Command Queuing	Enabled
Controller#1 SAS Port Mapping	<input checked="" type="checkbox"/> Port0 <input type="checkbox"/> Port1
Controller#2 SAS Port Mapping	<input checked="" type="checkbox"/> Port2 <input type="checkbox"/> Port3
LUN Base:LUN	0 : 0
<input type="checkbox"/> Confirm The Operation	
Submit Reset	

5.3.4.2 Volume Set Migration

Migration occurs when a Volume Set migrates from one RAID level to another, a Volume Set stripe size changes, or when a disk is added to a Raid Set. Migrating status is displayed in the Volume Set status area of the RaidSet Hierarchy screen during migration.



NOTE: The Stripe Size of a Raid30/50/60 Volume Set cannot be modified.

|open all|close all|

- Raid System Console
 - Quick Function
 - RAID Set Functions
 - Volume Set Functions
 - Security Functions
 - Physical Drives
 - System Controls
 - Information
 - RAID Set Hierarchy
 - SAS Chip Information
 - System Information
 - Hardware Monitor

<input type="checkbox"/> Stop Auto Refresh				
■ RAIDSet Hierarchy				
RAID Set	Devices	Volume Set(Ch/Lun)	Volume State	Capacity
Raid Set # 000	E#1Slot#1	Volume---VOL#000(0&4/0,N0.0)	Migrating(7.1%)	1000.0GB
	E#1Slot#2			
	E#1Slot#3			
	E#1Slot#4			
■ Enclosure#1 : SAS RAID Subsystem V1.0				
Device	Usage	Capacity	Model	
Slot#1(A)	Raid Set # 000	500.1GB	ATA WDC WD5003ABYX-0	
Slot#2(B)	Raid Set # 000	500.1GB	ATA WDC WD5003ABYX-0	
Slot#3(10)	Raid Set # 000	500.1GB	ATA WDC WD5003ABYX-0	
Slot#4(11)	Raid Set # 000	500.1GB	ATA WDC WD5003ABYX-0	
Slot#5(C)	Free	1000.2GB	ATA WDC WD10EADS-00M	
Slot#6(D)	Free	1000.2GB	ATA WDC WD10EADS-00M	
Slot#7(E)	Free	1000.2GB	ATA WDC WD10EADS-00M	
Slot#8(F)	Free	1000.2GB	ATA WDC WD10EADS-00P	
Slot#9	N.A.	N.A.	N.A.	

5.3.5 Check Volume Set

Use this function to perform Volume Set consistency check, which verifies the correctness of redundant data (data blocks and parity blocks) in a Volume Set. This basically means computing the parity from the data blocks and comparing the results to the contents of the parity blocks, or computing the data from the parity blocks and comparing the results to the contents of the data blocks.



NOTE: The Volume Set state must be Normal in order to perform Check Volume Set. Only RAID levels with parity (redundant data) such as RAID Levels 3, 5, 6, 30, 50 and 60, support this function.

To perform Check Volume Set function:

1. Click on the **Check Volume Set** link.
2. Tick from the list the Volume Set you want to check. Select the Check Volume Set options.

The screenshot shows the RAID System Console interface. On the left is a tree view with 'Check Volume Set' selected. The main panel is titled 'Select The Volume Set To Be Checked' and contains a table with the following data:

Select	Volume Set Name	On Raid Set	Capacity
<input type="checkbox"/>	Volume---VOL#000	Raid Set # 001	1000.0GB

Below the table are two checked options:

- Scrub Bad Block If Bad Block Is Found, Assume Parity Data Is Good.**
- Re-compute Parity If Parity Error Is Found, Assume Data Is Good.**

At the bottom, there is an unchecked option:

- Confirm The Operation**

Buttons for 'Submit' and 'Reset' are visible at the bottom of the panel.

Check Volume Set Options:

- **Scrub Bad Block If Bad Block Found, Assume Parity Data is Good**
- **Re-compute Parity if Parity Error, Assume Data is Good**



NOTE: When the 2 options are not selected, it will only check for errors. It is recommended to perform Check Volume Set with the 2 options unselected at first. If the result shows error, the two options can be selected and redo Check Volume Set to correct the errors.

3. Tick on **Confirm The Operation** and click on the **Submit** button. The Checking process will be started.

The checking percentage can also be viewed by clicking on RaidSet Hierarchy in the Information menu.

[open all][close all]

- 🔍 Raid System Console
- 📁 Quick Function
- 📁 RAID Set Functions
- 📁 Volume Set Functions
- 📁 Security Functions
- 📁 Physical Drives
- 📁 System Controls
- 📁 Information
 - 📁 RAID Set Hierarchy
 - 📁 SAS Chip Information
 - 📁 System Information
 - 📁 Hardware Monitor

Stop Auto Refresh				
RaidSet Hierarchy				
RAID Set	Devices	Volume Set(Ch/Lun)	Volume State	Capacity
Raid Set # 001	E#1Slot#4	Volume---VOL#000(0&4/0,N0.0)	Checking(0.0%)	1000.0GB
	E#1Slot#5			
	E#1Slot#6			
Enclosure#1 : SAS RAID Subsystem V1.0				
Device	Usage	Capacity	Model	
Slot#1(12)	Free	600.1GB	WD WD6000BKHG-02A29	
Slot#2(13)	Free	600.1GB	WD WD6000BKHG-02A29	
Slot#3(1C)	Free	600.1GB	WD WD6000BKHG-02A29	
Slot#4(1D)	Raid Set # 001	600.1GB	WD WD6000BKHG-02A29	
Slot#5(14)	Raid Set # 001	600.1GB	WD WD6000BKHG-02A29	
Slot#6(15)	Raid Set # 001	600.1GB	WD WD6000BKHG-02A29	
Slot#7(1A)	Free	600.1GB	WD WD6000BKHG-02A29	
Slot#8(1B)	Free	600.1GB	WD WD6000BKHG-02A29	
Slot#9(16)	Free	600.1GB	WD WD6000BKHG-02A29	
Slot#10(17)	Free	600.1GB	WD WD6000BKHG-02A29	
Slot#11(18)	Free	600.1GB	WD WD6000BKHG-02A29	
Slot#12(19)	Free	600.1GB	WD WD6000BKHG-02A29	



NOTE: The result of Check Volume Set function is shown in System Events Information and Volume Set Information. In System Events Information, it is shown in the Errors column. In Volume Set Information, it is shown in Errors Found field.

5.3.6 Schedule Volume Check

To perform Check Volume Set by schedule, follow these steps:

1. Click on the **Schedule Volume Check** link.
2. Select the desired schedule that you wish the Check Volume Set function to run. Tick on **Confirm The Operation** and click on the **Submit** button.

Scheduler: Disabled, 1Day (For Testing), 1Week, 2Weeks, 3Weeks, 4Weeks, 8Weeks, 12Weeks, 16Weeks, 20Weeks and 24Weeks.

Check After System Idle: No, 1 Minute, 3 Minutes, 5 Minutes, 10 Minutes, 15 Minutes, 20 Minutes, 30 Minutes, 45Minutes and 60 Minutes.



NOTE: To verify the Volume Check schedule, go to **Information -> RAID Set Hierarchy -> select the Volume Set -> the Volume Set Information will be displayed.**

■ Volume Set Information	
Volume Set Name	Volume--VOL#000
Raid Set Name	Raid Set # 000
Volume Capacity	7001.4GB
SAS Port/Lun	0/0
Raid Level	Raid 5
Stripe Size	64KBytes
Block Size	512Bytes
Member Disks	8
Cache Mode	Write Back
Tagged Queuing	Enabled
Volume State	Normal
Time To Volume Check	0:23:59:6

5.3.7 Stop Volume Check

Use this option to stop current running Check Volume Set process.

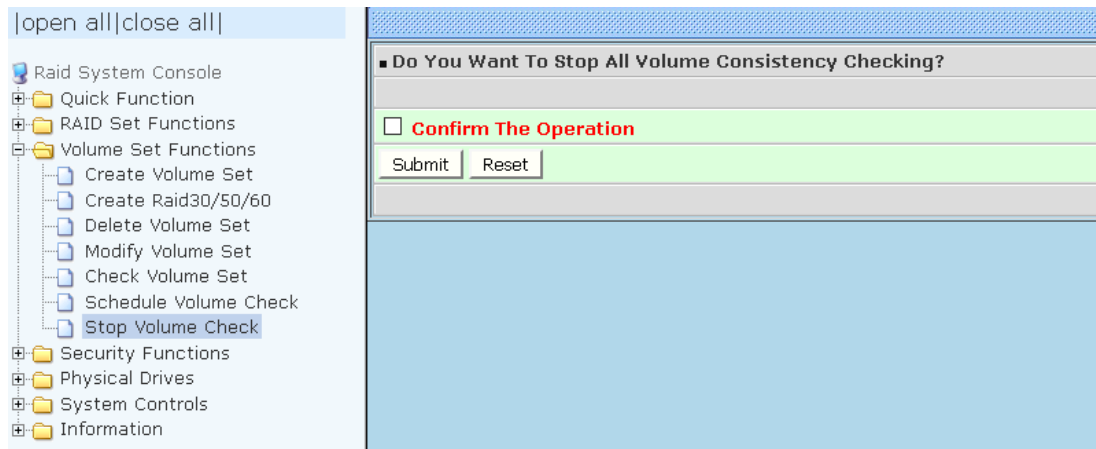

5.4 Security Functions

Protecting Drives with Self-Encrypting Drives (SED), a SED is a type of hard drive that automatically and continuously encrypts the data on the drive without any user interaction. The SED encryption is easy to use and manage with minimal impact on RAID controller performance that is invisible to the user, does not interfere in their workflow.

The SED function secures a volume's data from unauthorized access or modification in the event of drive theft, as well as more routine activities such as the return of defective drives for servicing or the decommission or repurposing of drives. The contents of a SED are always encrypted and the encryption keys are themselves encrypted and protected in hardware that cannot be accessed by other parts of the system. Local key management in the controller is designed to protect data from security breaches with minimal cost and complexity.

SEDs do all the cryptography within the disk drive internal controller, which means the disk encryption keys are never present in the RAID controller or memory, where they could be accessed by hackers. Encryption will conceal your volume's data and make accessing the files almost impossible for anyone who does not know your key. With this scramble process, no one can see and access into the hidden volume data without access key.



Note: SED security only works on logical drives composed of SED drives only.

How to enable SED functionality?

This Function is SED (self-encrypting drive technology) which support SED disks to provide Advanced Data Protection. The Security Key will enable the Disk Encryption at SED Raid Set.

1. Insert Self-Encrypting Drives (SEDs).
2. Login to storage management system. Please refer to Section 4.3 for more information.
3. Create SED Raid Set. See Section 5.4.1.
4. Create Volume Set. Refer to Section 5.3.1 Create Volume Set for detailed information about the Volume Set settings.
5. Create SED Key. See Section 5.4.4



NOTE: If SED Key "not enabled", then SED encryption is not enabled on that Raid Set.

5.4.1 Create SED RAID Set

Use the Create SED Raid Set function if you use SED (self-encryption drive) disks and need to encrypt the data, to use SED Raid Set to group SED drives. After Security Key is created, the SED Raid Set drives will automatically enable data encryption by Security Key. If Security Key is not enabled, the SED Raid Set will work as Normal Raid Set and disk data has no encryption.

|open all|close all|

Raid System Console

- Quick Function
- RAID Set Functions
- Volume Set Functions
- Security Functions
 - Create SED RAID Set**
 - Delete SED RAID Set
 - Delete ISE RAID Set
 - Security Key Setup
 - Import Security Key
 - Erase Failed Disk
 - RevertSP
- Physical Drives
- System Controls
- Information

■ Select The Drives For SED RAID Set

■ Enclosure# 1 : SAS RAID Subsystem V1.0

<input checked="" type="checkbox"/>	Slot#1	1000.2GB	ST1000NM0053-1C1173 (SED)
<input checked="" type="checkbox"/>	Slot#2	1000.2GB	ST1000NM0053-1C1173 (SED)
<input checked="" type="checkbox"/>	Slot#3	1000.2GB	ST1000NM0053-1C1173 (SED)

Raid Set Name: Raid Set # 000

RaidSet Mode: Max 128 Volumes

Confirm The Operation

Submit Reset

To create a SED Raid Set, click on the **Create SED RAID Set** link. A "Select The Drives For SED RAID Set" screen is displayed showing the Self-Encrypting Drives (SEDs) in the system.



NOTE:

The SED Raid Set can support below drive type. Can check the Supported Capability in the Device Information:

- 1. Trusted Computing Group (TCG) SED**
- 2. Secure Erase And Password (SATA)**
- 3. Cryptographic Erase And Password (SATA)**

Tick the box of each Self-Encrypting Drives (SEDs) that will be included in Raid Set to be created.

Raid Set Name	Raid Set # 000
RaidSet Mode	Max 128 Volumes
<input checked="" type="checkbox"/> Confirm The Operation	
Submit Reset	

Enter the preferred Raid Set Name (1 to 16 alphanumeric characters) to define a unique identifier for the Raid Set. Default Raid Set name always appear as **Raid Set # xxx**.

128 volumes is the default mode for SAS RAID controller, the 16 volumes mode is used for support roaming this raidset to SATA RAID controllers. The SATA RAID controller is designed to support up to 16 volumes only. You have to use "Max 16 volumes" on the raidset mode if you plan to roam this raidset between SAS RAID controller and SATA RAID controller.

Tick on the **Confirm The Operation** option and click on the **Submit** button in the screen.



NOTE: If SATA SED drives (with attached SAS bridge / MUX / dongle boards) are used in Dual Controller mode, the SED function cannot be used.



NOTE: Encryption in SED drives is enabled only when Create SED Raid Set. If create Normal Raid Set using SED drives, the Encryption is not enabled in those drives.



NOTE: In a SED Raid Set, the Rebuild/Expand/Clone/ Local Hot Spare can only select SED drive.



NOTE: For SSD with Block Erase Support: SATA SSD with Block Erase Support does not encrypt user data. It support Password Protect and "Instant Secure Erase" (may be longer erase time), it is included in SED Support. The difference is if Raid Set is deleted and NOT Secure Erased (Block Erase), the original data is still in the drive and accessible without Encryption.

5.4.2 Delete SED RAID Set

RAID System Console

- Quick Function
- RAID Set Functions
 - Volume Set Functions
 - Security Functions
 - Create SED RAID Set
 - Delete SED RAID Set
 - Delete ISE RAID Set
 - Security Key Setup
 - Import Security Key
 - Erase Failed Disk
 - RevertSP
- Physical Drives
- System Controls
- Information

Select The SED Raid Set To Delete

Select	Raid Set Name	Member Disks	Raid State	Capacity
<input checked="" type="radio"/>	Raid Set # 000 (SED)	3/3	Normal	3000.0GB

Delete Options

Secure Erase The Member Disks Confirmation Code Required "148674" All Data Will Be Lost And No Way To Recover

Confirm The Operation, VolumeSet In This RaidSet Will Also Be Offlined

Submit Reset

To delete a SED Raid Set, click on the **Delete SED RAID Set** link. A "Select The SED Raid Set To Delete" screen is displayed showing all Raid Sets existing in the system. Select the Raid Set you want to delete in the Select column.

Delete Options

Secure Erase The Member Disks Confirmation Code Required "148674" All Data Will Be Lost And No Way To Recover

Confirm The Operation, VolumeSet In This RaidSet Will Also Be Offlined

Submit Reset

If want to Security Erase the SED Raid Drive at Same Time, Tick On the **Secure erase the member disks** and Key In Correct **Confirmation Code**.

Confirmation Code:

Confirmation code is shown on the screen. This Code is produced by Controller. If tick on the "Secure Erase The Member Disks" but did not input the Confirmation Code or wrong Confirmation Code is entered, the Secure Erase will not be executed.



NOTE: Be careful when this options is selected, all data will be lost and no way to recover.

Tick on the **Confirm The Operation** and click on the **Submit** button to process with deletion.



NOTE: After Delete SED RAID Set, the Security Key will be disabled at same time in the SED RAID Set member disks, if Security Key was enabled before.

5.4.3 Delete ISE RAID Set

The screenshot shows the RAID System Console interface. On the left is a navigation tree with categories like 'Quick Function', 'RAID Set Functions', 'Volume Set Functions', 'Security Functions', 'Physical Drives', 'System Controls', and 'Information'. The 'Delete ISE RAID Set' option is highlighted under 'Security Functions'. The main area displays a table for selecting a RAID set to delete and a 'Delete Options' section.

Select	Raid Set Name	Member Disks	Raid State	Capacity
<input checked="" type="radio"/>	Raid Set # 000	3/3	Normal	3000.0GB

Delete Options

Secure Erase The Member Disks Confirmation Code Required "553407" All Data Will Be Lost And No Way To Recover

Confirm The Operation, VolumeSet In This RaidSet Will Also Be Offlined

Instant Secure Erase (ISE) is designed to protect data on hard disk drives by instantly resetting the drive back to factory settings and changing the encryption key so that any data remaining on the drive is cryptographically erased. This means all data on the drive is permanently and instantly unreadable.

Non-SED drives (such as ISE-only drives) are supported in Normal Raid Set. If the Normal Raid Set, with some ISE member drives with Instant Secure Erase Capability, will be deleted, use the Delete ISE RAID Set.

To delete a ISE Raid Set, click on the **Delete ISE RAID Set** link. A "Select The ISE Raid Set To Delete" screen is displayed with Raid Set member disks including existing Instant Secure Erase capable drives. Select the Raid Set you want to delete in the Select column.

The screenshot shows the 'Delete Options' section. The 'Secure Erase The Member Disks' checkbox is unchecked. The confirmation code field contains '148674'. The 'Confirm The Operation, VolumeSet In This RaidSet Will Also Be Offlined' checkbox is checked.

Secure Erase The Member Disks Confirmation Code Required "148674" All Data Will Be Lost And No Way To Recover

Confirm The Operation, VolumeSet In This RaidSet Will Also Be Offlined

If want to Security Erase the ISE Raid Drive at Same Time, Tick On the **Secure erase the member disks** and Key In Correct **Confirmation Code**.

Confirmation Code:

Confirmation code is shown on the screen. This Code is produced by Controller. If tick on the "Secure Erase The Member Disks" but did not input the Confirmation Code or wrong Confirmation Code is entered, the Secure Erase will not be executed.



NOTE: Be careful when this options is selected, all data will be lost and no way to recover.

Tick on the **Confirm The Operation** and click on the **Submit** button to process with deletion.

5.4.4 Security Key Setup

Security Key Setup options are: Create / Disable / Change / Export - Security Key for SED RAID Set. The Security Key is global for all SED RAID Set. When SED RAID Set is created and Security Key is enabled, the Security Function will be enabled in the SED RAID Set member disks without any sequence.

To set the security key configuration options, click the **Security Key Setup** link under the **Security Functions** menu.

The screenshot shows the RAID System Console interface. On the left is a navigation tree with the following items: Raid System Console, Quick Function, RAID Set Functions, Volume Set Functions, Security Functions (expanded), Physical Drives, System Controls, and Information. Under Security Functions, the following options are listed: Create SED RAID Set, Delete SED RAID Set, Delete ISE RAID Set, Security Key Setup (highlighted), Import Security Key, Erase Failed Disk, and RevertSP. The main content area is titled 'SED Key Management' and contains the following configuration options:

- Create SED Key Automatically: SED Key Created And Saved For SED Raid use
- Create SED Key By User Password: 12345678
- Raid Storage Manager Password Required: [Masked]
- Confirm The Operation
- Buttons: Submit, Reset

5.4.4.1 Create Security Key

There are two options to enable SED Key.

1. Create SED Key Automatically: the controller will automatically generate the SED Key.
2. Create SED Key By User Password: user defined password. The SED Key characters allowed are 'A' - 'Z', 'a' - 'z', and '0' - '9'. The minimum number of Password characters is 4.



NOTE: Once the SED Key has been set, the user can only lock and unlock the data by providing the correct SED Key.

Enter the RAID Storage Manager Password (default is 00000000) to login. Tick the **"Confirm The Operation"** and click **"Submit"**.



NOTE: The browser will prompt you to remember your password. We strongly recommend you not allow AutoComplete to save passwords. Do not store/save Raid Storage Manager Password in the web browser (cache). If Raid Storage Manager Password is saved in web browser and then configure Security Key Setup, the Raid Storage Manager Password will be automatically inputted by web browser. Suggestion is to enter the Raid Storage Manager Password every time for better security in the Security Key Setup.

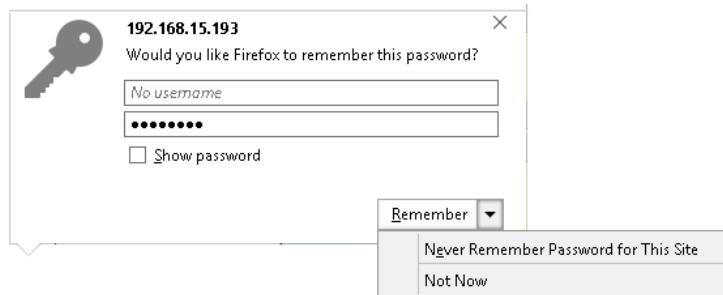

IMPORTANT: The SED Key must be exported regularly and add date and time at the exported Key filename. The default Key filename is SEDKEY256.BIN. Suggestion is to add date and time, e.g. 201702091210_SEDKEY256.BIN at every Export Key file. These Key file can provide more protection of the saved Key. Refer to next Section for exporting Key.

5.4.4.2 Modify Security Key

After create Security Key, next time to use the SED Key Management, the function will change to Change / Disable / Export Security Key for the global SED Raid Set.

To change, disable or export the SED Key, click the **Security Key Setup** link under the **Security Functions** menu.

|open all|close all|

<ul style="list-style-type: none"> Raid System Console Quick Function RAID Set Functions Volume Set Functions Security Functions <ul style="list-style-type: none"> Create SED RAID Set Delete SED RAID Set Delete ISE RAID Set Security Key Setup Import Security Key Erase Failed Disk RevertSP Physical Drives System Controls Information 	<div style="background-color: #e6f2ff; padding: 2px; margin-bottom: 5px;"> SED Key Management </div> <table border="1" style="width: 100%; border-collapse: collapse;"> <tr> <td><input checked="" type="radio"/> Change SED Key</td> <td>Generate New SED Key For Use Automatically</td> </tr> <tr> <td><input type="radio"/> Change SED Key By User Password</td> <td><input type="text"/></td> </tr> <tr> <td><input type="radio"/> Disable SED Key</td> <td>Clear Saved SED Key, SED Raid Set Key Is Also Disabled</td> </tr> <tr> <td><input type="radio"/> Export SED Key</td> <td>Export SED Key File For Later Use Or Roaming</td> </tr> <tr> <td>Raid Storage Manager Password Required</td> <td><input type="text" value="....."/></td> </tr> <tr> <td colspan="2" style="text-align: center;"><input checked="" type="checkbox"/> Confirm The Operation</td> </tr> <tr> <td colspan="2" style="text-align: center;"> <input type="button" value="Submit"/> <input type="button" value="Reset"/> </td> </tr> </table>	<input checked="" type="radio"/> Change SED Key	Generate New SED Key For Use Automatically	<input type="radio"/> Change SED Key By User Password	<input type="text"/>	<input type="radio"/> Disable SED Key	Clear Saved SED Key, SED Raid Set Key Is Also Disabled	<input type="radio"/> Export SED Key	Export SED Key File For Later Use Or Roaming	Raid Storage Manager Password Required	<input type="text" value="....."/>	<input checked="" type="checkbox"/> Confirm The Operation		<input type="button" value="Submit"/> <input type="button" value="Reset"/>	
<input checked="" type="radio"/> Change SED Key	Generate New SED Key For Use Automatically														
<input type="radio"/> Change SED Key By User Password	<input type="text"/>														
<input type="radio"/> Disable SED Key	Clear Saved SED Key, SED Raid Set Key Is Also Disabled														
<input type="radio"/> Export SED Key	Export SED Key File For Later Use Or Roaming														
Raid Storage Manager Password Required	<input type="text" value="....."/>														
<input checked="" type="checkbox"/> Confirm The Operation															
<input type="button" value="Submit"/> <input type="button" value="Reset"/>															

Using “Change SED Key” and “Change SED Key By User Password” can change Security Password to new one.



NOTE: Create SED Key By User Password, the SED Key characters allowed are 'A' – 'Z', 'a' – 'z', and '0' – '9'. The minimum number of Password characters is 4.



NOTE: If need to change the SED Key, the RAID system and all device must be at Normal Status:

- 1. No failed SED Disk**
- 2. The SED Raid Set must not be in Offline status**
- 3. In dual controller mode, other controller must not be at “Restarting Controller” status**
- 4. In dual controller mode, both controllers must be operational and no failed controller**

If not, may be some disk’s SED Key not matched will happen.

“Disable SED Key” is to disable Security key for all SED Raid Sets in the RAID unit. This will also clear saved SED key.

“Export SED Key” can store Security key to a file for later use or roaming.

After selecting an option, need to provide the “Raid Storage Manager Password Required” for security confirmation, and then tick on the “**Confirm The Operation**” and click **Submit**.



NOTE: The browser will prompt you to remember your password. We strongly recommend you not allow AutoComplete to save passwords. Do not store/save Raid Storage Manager Password in the web browser (cache). If Raid Storage Manager Password is saved in web browser and then configure Security Key Setup, the Raid Storage Manager Password will be automatically inputted by web browser. Suggestion is to enter the Raid Storage Manager Password every time for better security in the Security Key Setup.



IMPORTANT: The SED Key must be exported regularly and add date and time at the exported Key filename. The default Key filename is SEDKEY256.BIN. Suggestion is to add date and time, e.g. 201702091210_SEDKEY256.BIN at every Export Key file. These Key file can provide more protection of the saved Key.

5.4.5 Import Security Key

Import Security Key provides function to import Security Key to unlock/Locked Disks.

To Import Security Key, click the **Import Security Key** link under the **Security Functions** menu.

Enter The SED Key File: Click the [Browse...] button and select SED Key File first, then choose a type to unlock Locked Disk.

Import Security Key supports 2 functions: **RaidSet Roaming** and **Change SED Key**.

RaidSet Roaming: Use to Unlock Locked Disk and Personalize to current system SED Key.

Change SED Key: Use to Unlock Locked Disk If Any and Change system SED Key To This One. If the Security Key function is not enabled, after unlock Locked Disks the Security Key will be enabled automatically.

After selecting an option, need to provide the "Raid Storage Manager Password Required" for security confirmation, and then tick on the "**Confirm The Operation**" and click **Submit**.



NOTE: The browser will prompt you to remember your password. We strongly recommend you not allow AutoComplete to save passwords. Do not store/save Raid Storage Manager Password in the web browser (cache). If Raid Storage Manager Password is saved in web browser and then configure Security Key Setup, the Raid Storage Manager Password will be automatically inputted by web browser. Suggestion is to enter the Raid Storage Manager Password every time for better security in the Security Key Setup.



IMPORTANT: The SED Key must be exported regularly and add date and time at the exported Key filename. The default Key filename is SEDKEY256.BIN. Suggestion is to add date and time, e.g. 201702091210_SEDKEY256.BIN at every Export Key file. These Key file can provide more protection of the saved Key.

5.4.6 Erase Failed Disk

The Erase Failed Disk function can be used to securely erase a SED or ISE disk that is failed. User can select to erase its content. If failed disk is not accessible and this function fails, in this case, failed disk can be power cycled and try again.

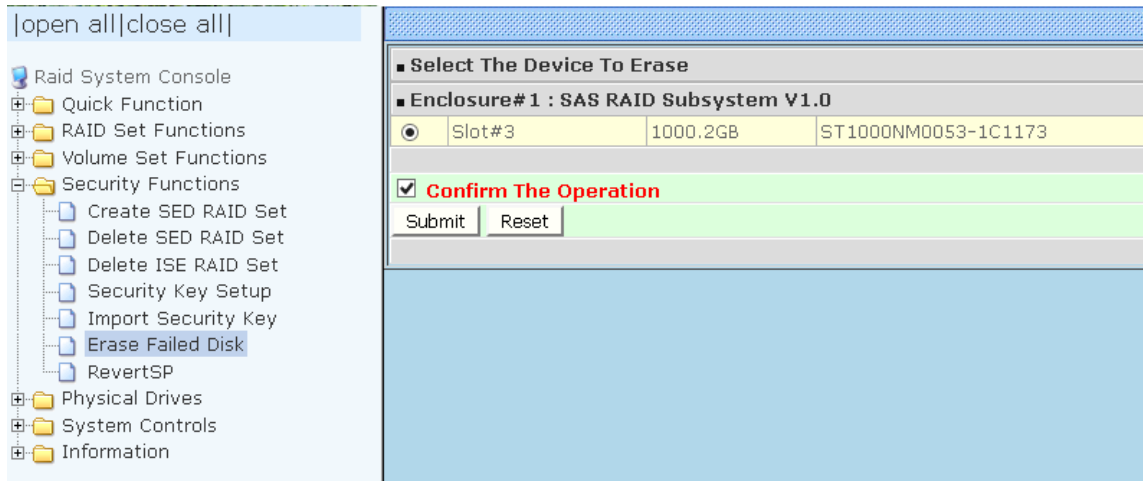

To securely erase the SED or ISE failed disk, choose and click the failed disk Slot# and tick on the "**Confirm The Operation**" and click **Submit**. After secure erase failed disk, there is no way to recover original data.

5.4.7 RevertSP

If a disk has been Locked and cannot be Unlocked, then need to use RevertSP to return disk to Factory Default. After execute RevertSP to reset disk to Factory Default, there is no way to recover original data.

Please contact your vendor's support engineer for assistance.

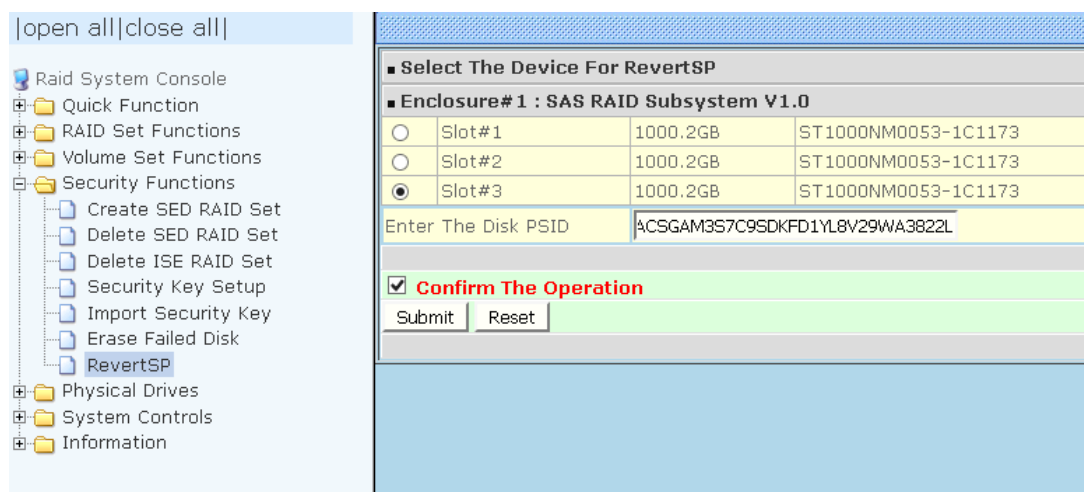

NOTE: Pass-Through Disk and JBOD mode do not support SED Function.

5.4.8 SED Information

Use this feature to view the RAID subsystem’s existing SED Raid Set(s) and SED disk drive(s) configuration and information. Select the **RAID Set Hierarchy** link from the **Information** menu to display the Raid Set Hierarchy screen.

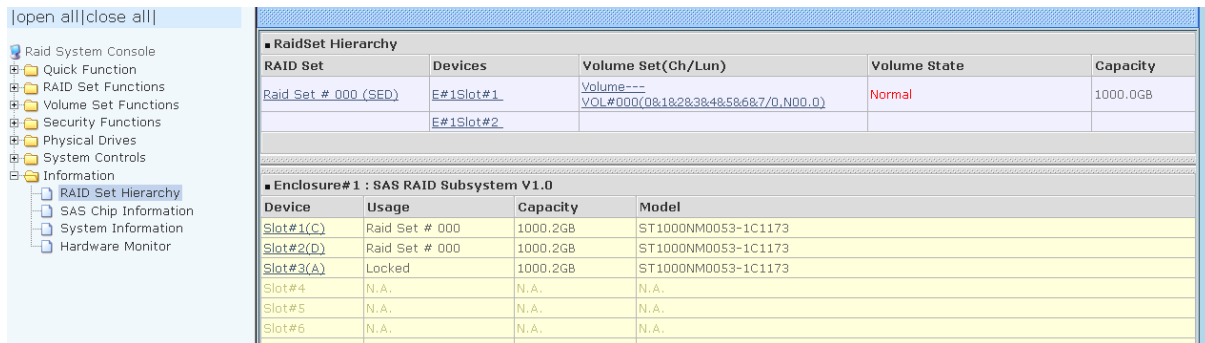

To view the Raid Set information, click the **Raid Set #** link from the Raid Set Hierarchy screen. The Raid Set Information screen appears.

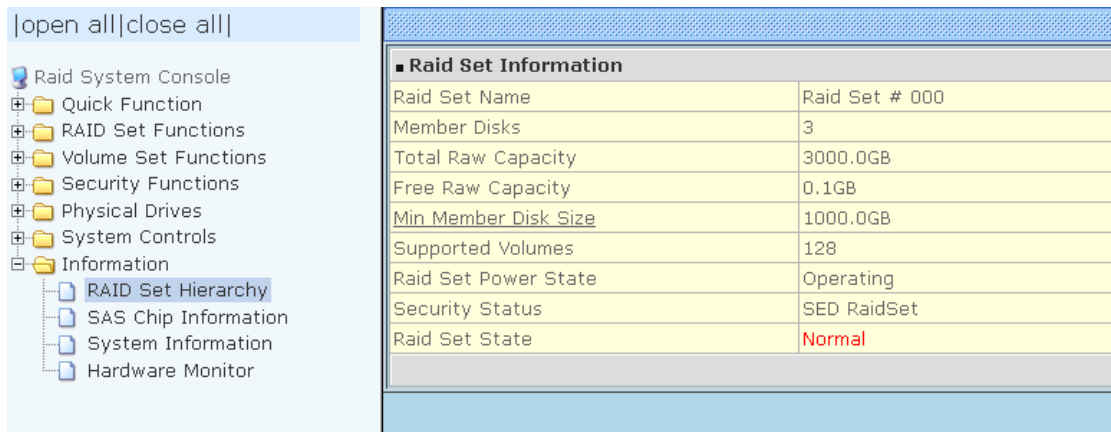

The Raid Set Hierarchy can show SED Raid Sets, click the Raid Set name link and check the Raid Set Information for Security Status:

Security Status	Description
N/A	Non-SED or ISE Disk
x/y ISE Disks	Number of ISE disks included in the Raid Set x: ISE Disk Count; if SED Disk is used to create Normal Raid Set this will display ISE Disk. y: Total Disk Count.
SED Raid Set	SED Raid Set has member SED disks.

To view the disk drive information, click the **E# Slot#** link from the Raid Set Hierarchy screen. The Device Information screen appears. This screen shows various information such as disk drive model name, serial number, firmware revision, disk capacity, **Security Capability**, **Security State**, timeout count, media error count, Hdd Xfer Speed and SMART information.

[open all][close all]

- 🔍 RAID System Console
- 📁 Quick Function
- 📁 RAID Set Functions
- 📁 Volume Set Functions
- 📁 Security Functions
- 📁 Physical Drives
- 📁 System Controls
- 📁 Information
 - 📄 RAID Set Hierarchy
 - 📄 SAS Chip Information
 - 📄 System Information
 - 📄 Hardware Monitor

■ Device Information	
Device Type	SATA(5001B4D51D77E01C)
Device Location	Enclosure#1 Slot#1
Model Name	ST1000NM0053-1C1173
Serial Number	Z1W1MES9
Firmware Rev.	SS06
Disk Capacity	1000.2GB
Physical Block Size	512
Logical Block Size	512
Current SATA Mode	SATA600+NCQ(Depth32)
Supported SATA Mode	SATA600+NCQ(Depth32)
Error Recovery Control (Read/Write)	Disabled/Disabled
Disk Power Control	EPC(Active)
Device State	Normal
Security Capability	TCG SED
Security State	Unlocked
Timeout Count	0
Media Error Count	0
Hdd Xfer Speed	Show Result
Rotation Speed	7200(RPM)
Device Temperature	35 °C
48Bit LBA Support	Yes
SMART Read Error Rate	100(44)
SMART Spinup Time	97(0)
SMART Reallocation Count	100(10)
SMART Seek Error Rate	69(30)
SMART Spinup Retries	100(97)
SMART Calibration Retries	N.A.(N.A.)
SSD Reserved Space	N.A.(N.A.)
SSD Wearing Indicator	N.A.(N.A.)

The SMART Attribute(Threshold) Is A Normalized Value, The Value Is The Larger The Better.
If The Attribute Value Is Smaller Than The Threshold Value, The Disk Is In Unstable State.

Device Information has 2 fields displayed about disk Security Type and Status, which are:

1. Security Capability
2. Security State

Below table is the description.

Security Capability

Security Capability	Description	Shows the drive security capability, for example: Cryptographic Erase, TCG SED
N/A	Normal disk, Non-ISE disk	Can be used to create Normal Raid Set
Cryptographic Erase	ISE Secure Erase - Some SAS Disks Only Support Encryption without Password	Can be used to create Normal Raid Set
Cryptographic Erase And Password	ISE Sanitize with Crypto erase - Some SAS/SATA Support this Type of Operation	Can be used to create Normal Raid Set and also SED Raid Set
Secure Erase And Password	<ul style="list-style-type: none"> • Password & FDE (Full-Disk-Encryption) with Password Protect - Some SATA Disk Support Password and Encryption • SSD with Block Erase and Password 	Can be used to create Normal Raid Set and also SED Raid Set
Block Erase	SSD with Block Erase	Can be used to create Normal Raid Set
TCG SED	Full SED Function Support	Can be used to create Normal Raid Set and also SED Raid Set

Security State

Security State	Description
N/A	Non-SED Disk
Disabled	Not Personalized, No SED Key Setup.
Unlocked	Personalized, Operational by SED Key enabled and Key is match
	Comment: Every time the SED Key is changed, it is necessary to export the SED Key and save by time record (Date and Time).
Locked	Personalized, SED Key is not match
	Comment: Import SED Key is required.

5.5 Physical Drive

Choose this option from the Main Menu to select a disk drive and to perform the functions listed below.

5.5.1 Create Pass-Through Disk

A Pass-Through Disk is a disk drive not controlled by the internal RAID subsystem firmware and thus cannot be a part of a Volume Set. A Pass-Through disk is a separate and individual Raid Set. The disk is available to the host as an individual disk. It is typically used on a system where the operating system is on a disk not controlled by the RAID firmware.

To create pass-through disk, click on the **Create Pass-Through** link under the Physical Drives main menu. The setting function screen appears.

Select the disk drive to be made as Pass-Through Disk and configure the Pass-Through Disk attributes, such as the Cache Mode, Tagged Command Queuing, and SAS Port/LUN Base/LUN for this volume.

|open all|close all|

- Raid System Console
 - Quick Function
 - RAID Set Functions
 - Volume Set Functions
 - Security Functions
 - Physical Drives
 - Create Pass-Through Disk
 - Modify Pass-Through Disk
 - Delete Pass-Through Disk
 - Clone Disk
 - Abort Cloning
 - Set Disk To Be Failed
 - Activate Failed Disk
 - Identify Enclosure
 - Identify Drive
 - System Controls
 - Information

■ Select the IDE drive For Pass Through

■ Enclosure#1 : SAS RAID Subsystem V1.0

<input checked="" type="radio"/>	Slot#1	300.1GB	HGST HUC101830CSS200
<input type="radio"/>	Slot#2	300.1GB	HGST HUC101830CSS200
<input type="radio"/>	Slot#3	300.1GB	HGST HUC101830CSS200
<input type="radio"/>	Slot#4	300.1GB	HGST HUC101830CSS200

■ Enter Pass Through Disk Attribute

Volume Cache Mode: Write Back

Write Protection: Disabled

Tagged Command Queuing: Enabled

Controller#1 SAS Port Mapping: Port0 Port1

Controller#2 SAS Port Mapping: Port2 Port3

LUN Base:LUN: 0 : 0

Confirm The Operation

Submit Reset

5.5.2 Modify a Pass-Through Disk

Use this option to modify the attribute of a Pass-Through Disk. User can modify the Cache Mode, Tagged Command Queuing, and SAS Port/LUN Base/LUN on an existing Pass-Through Disk.

To modify the Pass-Through drive attribute from the Pass-Through drive pool, click on the **Modify a Pass-Through Disk** link. The "Select The Pass-Through Disk For Modification" screen appears. Tick on the Pass-Through Disk from the Pass-Through drive pool and click on the **Submit** button to select the drive.

The Enter Pass-Through Disk Attribute screen appears. Modify the drive attribute values as you want.

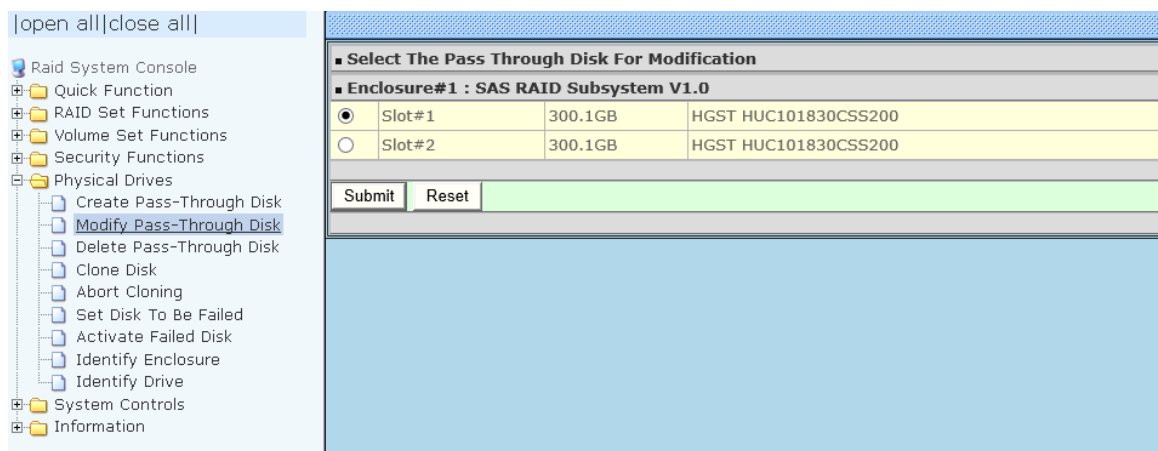

The Enter Pass-Through Disk Attribute screen appears. Modify the drive attribute values as you want.

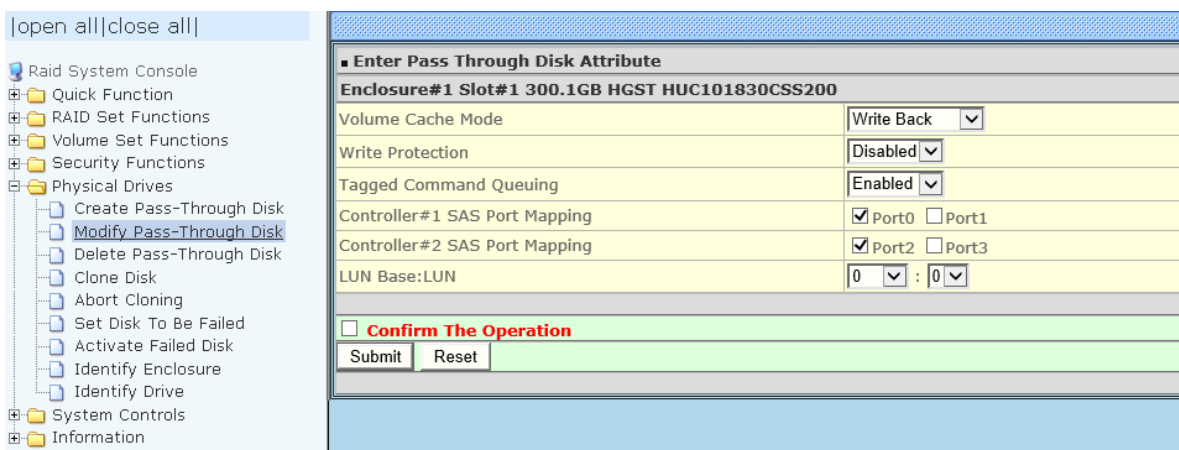

5.5.3 Delete Pass-Through Disk

To delete Pass-Through Disk from the Pass-Through drive pool, click on **Delete Pass-Through** link. Select a Pass-Through Disk, tick on the **Confirm The Operation** and click the **Submit** button to complete the delete action.

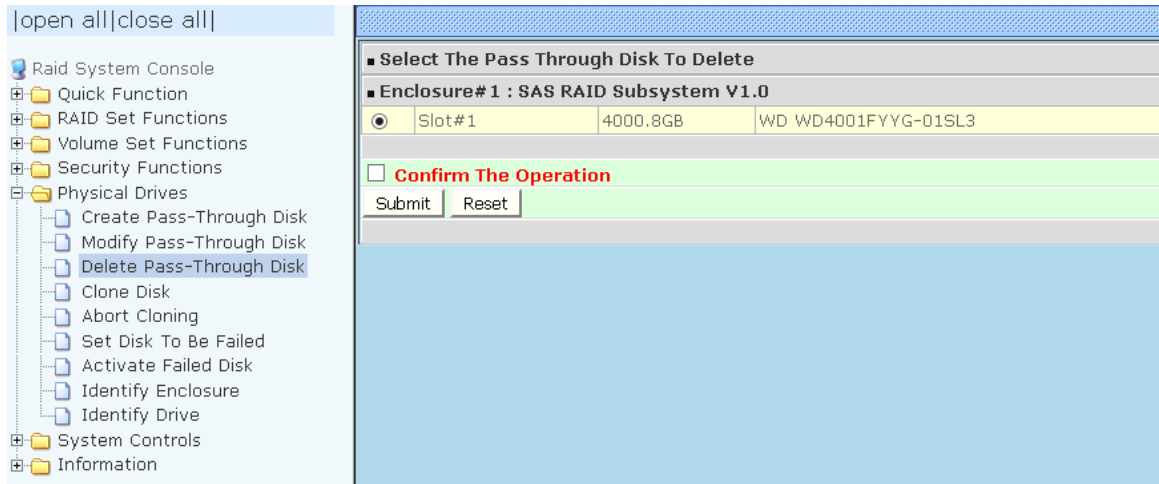

5.5.4 Clone Disk

Instead of deleting a RAID set and recreating it with larger disk drives, the "Clone Disk" function allows the users to replace larger disk drives to the RAID set that have already been created. Click on the "Clone Disk" option on the "Physical Drives" link to enable the clone function. If there is an available disk, then the "Select The Drives For Cloning" screen appears. There are two "Clone Disk" function options: "Clone And Replace" and "Clone Only."

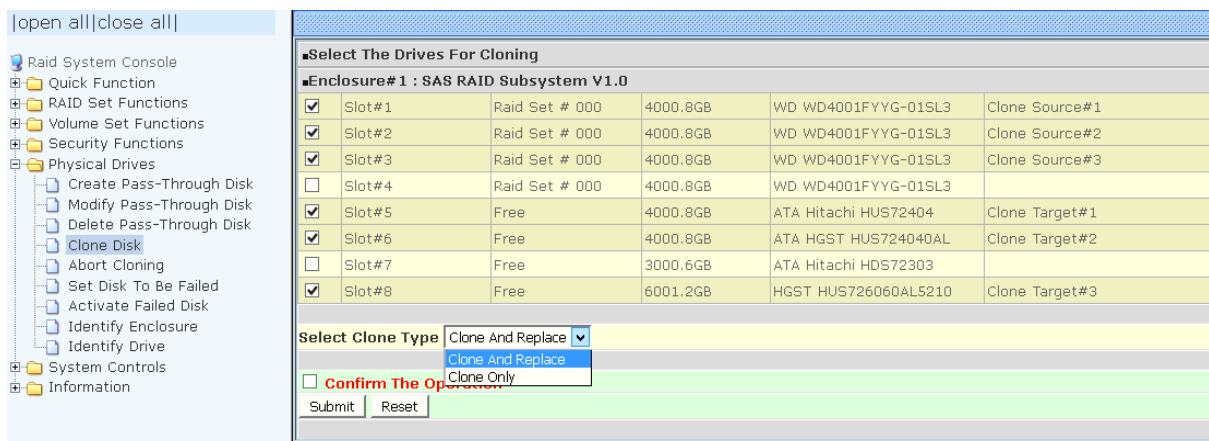

Clone Disk Procedure

1. Select one of the members as the "Clone Source" (status indicated as Raid Set #) by clicking on the appropriate check box.



NOTE: An error message will be showed on the screen, when the selected disk is not in a Raid Set.

The screenshot shows the RAID System Console interface. On the left is a navigation tree with 'Clone Disk' selected under 'Physical Drives'. The main area displays a 'Controller Response' window with a yellow background and the error message: 'Clone Source Disk Must Be In A Raid Set'.

2. Select a "Clone Target" (status indicated as Free or Hot Spare) by clicking on the appropriate check box.
3. If you have available disk member, you can repeat above procedures to define another clone pair.
4. Select clone type.

The pair number for both the "Clone Source" and the "Clone Target" will be indicated in the screen. Tick on the "Confirm The Operation" check box and click on the "Submit" button on the screen; the controller will automatically start the cloning process using the existing "stand-by" (Free or Hot Spare drive) to clone the source drive (the Raid Set member drive). The cloning process percentage will be indicated in the "Volume State" area of the "RAID Set Hierarchy" screen. Completion of the Clone function process will be indicated by a notification message on the event log.

The screenshot shows the RAID System Console interface with the 'RAID Set Hierarchy' table. The table shows 'Raid Set # 000' with a 'Cloning(0.2%)' status. Below it, the 'Enclosure# 1 : SAS RAID Subsystem V1.0' table lists various disk slots and their usage.

RAID Set	Devices	Volume Set(Ch/Lun)	Volume State	Capacity
Raid Set # 000	E#1Slot#1	Volume---VOL#000(0&4/0,N00,0)	Cloning(0.2%)	100.0GB
	E#1Slot#2			
	E#1Slot#3			
	E#1Slot#4			

Device	Usage	Capacity	Model
Slot#1(A)	Raid Set # 000	4000.8GB	WD WD4001FYYG-01SL3
Slot#2(B)	Raid Set # 000	4000.8GB	WD WD4001FYYG-01SL3
Slot#3(14)	Raid Set # 000	4000.8GB	WD WD4001FYYG-01SL3
Slot#4(15)	Raid Set # 000	4000.8GB	WD WD4001FYYG-01SL3
Slot#5(C)	Clone:E#1Slot#1	4000.8GB	ATA Hitachi HUS72404
Slot#6(D)	Clone:E#1Slot#2	4000.8GB	ATA HGST HUS724040AL
Slot#7(12)	Free	3000.6GB	ATA Hitachi HDS72303
Slot#8(13)	Clone:E#1Slot#3	6001.2GB	HGST HUS726060ALS210

5.5.4.1 Clone And Replace

You can enlarge your logical drives by copying and replacing all member drives with drives of higher capacity. The existing data in the logical drives is copied onto the new drives, and then the original members are marked as "Offlined".

5.5.4.2 Clone Only

The stand-by disk will clone the logical drives without substituting it. The status of the stand-by drive will be marked as "Offlined" after the cloning process. The source drive will remain a member of the logical drive.

5.5.5 Abort Cloning

Use this function to stop the ongoing clone disk action.

The screenshot shows the RAID System Console interface. On the left is a navigation tree with 'Physical Drives' expanded and 'Abort Cloning' selected. The main window displays a dialog titled 'Select The Raid Set To Abort Cloning'.

Select	Raid Set Name	Member Disks	Raid State	Capacity
<input checked="" type="radio"/>	Raid Set # 000	4/4	Cloning	16000.0GB

Below the table, there is a checkbox labeled 'Confirm The Operation, VolumeSet In This RaidSet Will Also Be Offlined' which is currently unchecked. At the bottom of the dialog are 'Submit' and 'Reset' buttons.

The screenshot shows the RAID System Console interface after the cloning process has been aborted. The main window displays a dialog titled 'Controller Response' with a yellow background and the text 'RaidSet Cloning Aborted' in red.

5.5.6 Set Disk To Be Failed

It sets a normal working disk as **failed** so that users can test some of the features and functions.



NOTE: When you want to set a disk as failed, please contact your vendor's support engineer for assistance.

|open all|close all|

- 🔗 Raid System Console
 - 📁 Quick Function
 - 📁 RAID Set Functions
 - 📁 Volume Set Functions
 - 📁 Security Functions
 - 📁 Physical Drives
 - 📄 Create Pass-Through Disk
 - 📄 Modify Pass-Through Disk
 - 📄 Delete Pass-Through Disk
 - 📄 Clone Disk
 - 📄 Abort Cloning
 - 📄 **Set Disk To Be Failed**
 - 📄 Activate Failed Disk
 - 📄 Identify Enclosure
 - 📄 Identify Drive
 - 📁 System Controls
 - 📁 Information

■ Select The Device To Set To Fail			
■ Enclosure# 1 : SAS RAID Subsystem V1.0			
<input checked="" type="radio"/>	Slot#1	4000.8GB	WD WD4001FYYG-01SL3
<input type="radio"/>	Slot#2	4000.8GB	WD WD4001FYYG-01SL3
<input type="radio"/>	Slot#3	4000.8GB	WD WD4001FYYG-01SL3
<input type="radio"/>	Slot#4	4000.8GB	WD WD4001FYYG-01SL3
<input type="radio"/>	Slot#5	4000.8GB	ATA Hitachi HUS72404
<input type="radio"/>	Slot#6	4000.8GB	ATA HGST HUS724040AL
<input type="radio"/>	Slot#7	3000.6GB	ATA Hitachi HDS72303
<input type="radio"/>	Slot#8	6001.2GB	HGST HUS726060AL5210

Confirm The Operation

5.5.7 Activate Failed Disk

It forces the current **failed** disk in the system to be back online. **Activate Failed Disk** function has no effect on the removed disks, because a **removed** disk does not give the controller a chance to mark it as **failure**.

Followings are considered as **Removed-Disk**:

- (1). Manually removed by user
- (2). Losing PHY connection due to bad connector, cable, backplane
- (3). Losing PHY connection due to disk fail

Basically, in the eyes of the controller, the disk suddenly disappears due to whatever reason.

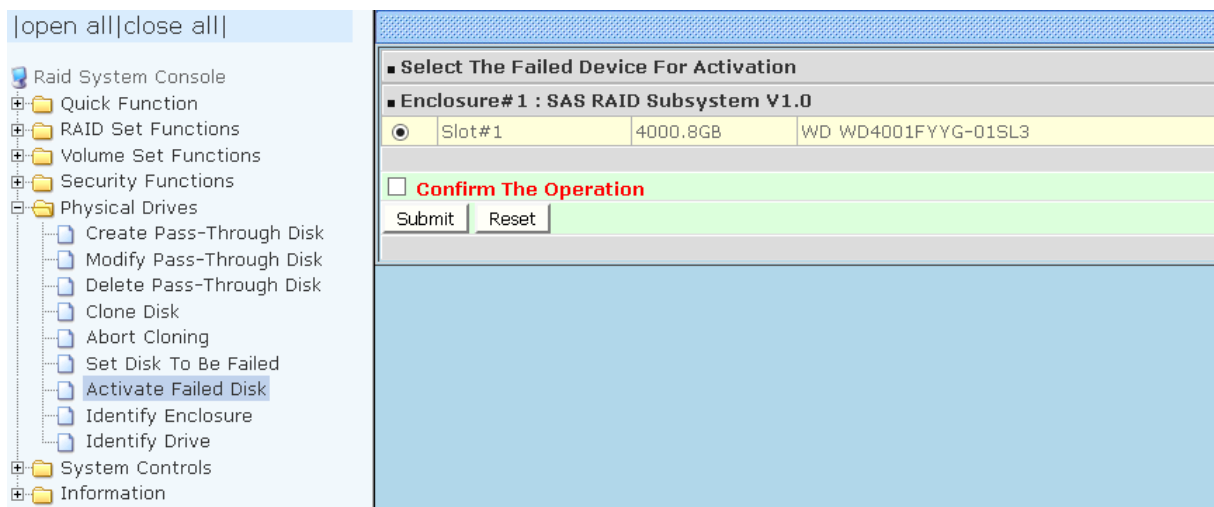

5.5.8 Identify Enclosure

To identify an Enclosure, move the mouse cursor and click on **Identify Enclosure** link. The **Select The Enclosure For Identification** screen appears. Tick on the enclosure from the list of enclosures, then click on the **Submit** button to identify the selected enclosure. All disk drives' Status LEDs in an enclosure will be blinking when a particular enclosure is selected.

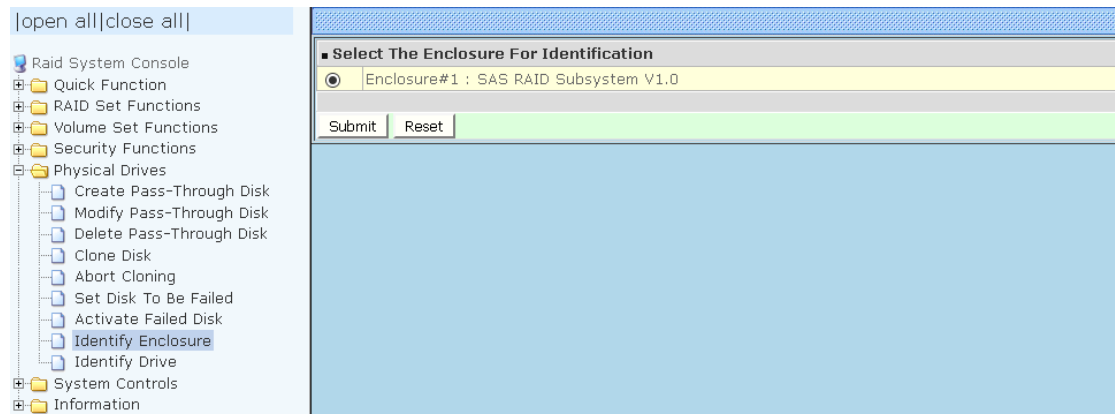

5.5.9 Identify Selected Drive

Use this option to physically locate a selected drive to prevent removing the wrong drive. When a disk drive is selected using the **Identify Drive** function, the Status LED of the selected disk drive will be blinking Red.

To identify a selected drive from the drives pool, click on the **Identify Drive** link. The "Select The IDE Device For identification" screen appears. Tick on the IDE device from the drives list. After completing the selection, click on the **Submit** button to identify selected drive.

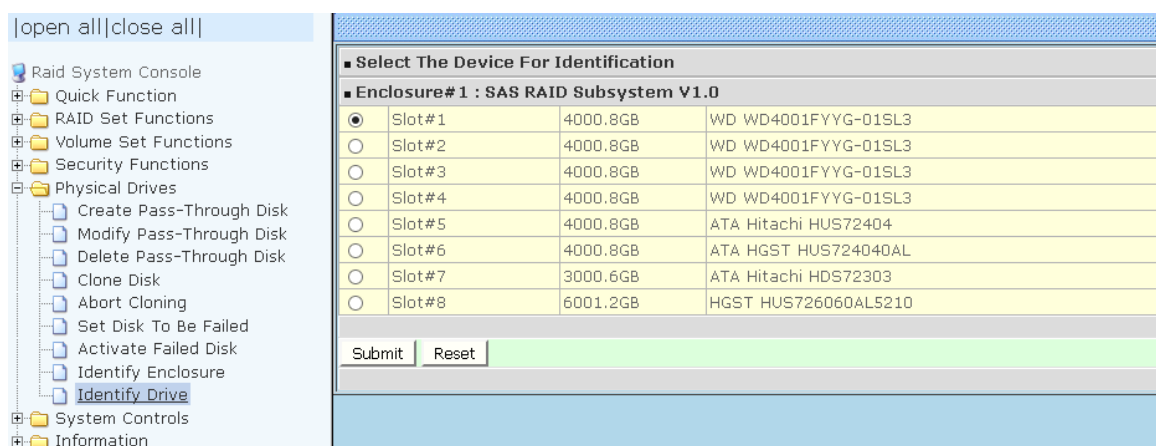

5.6 System Controls

5.6.1 System Configuration

To set the RAID subsystem system configuration options, click the **System Configuration** link under the **System Controls** menu. The System Configurations screen will be shown. Set the desired system option as needed.

System Configurations	
System Beeper Setting	Enabled
Background Task Priority	High(80%)
JBOD/RAID Configuration	RAID
SATA NCQ Support	Disabled
HDD Read Ahead Cache	Enabled
Volume Data Read Ahead	Normal
HDD Queue Depth	32
Empty HDD Slot LED	ON
Auto Activate Incomplete Raid	Disabled
Disk Write Cache Mode	Enabled
Write Same For Initialization	SAS And SATA
Hot Plugged Disk For Rebuilding	Always
Disk Capacity Truncation Mode	Multiples Of 1G
Smart Option For HDD	Failed The Drive
Smart Polling Interval	On Demand

Confirm The Operation

Submit Reset

System Beeper Setting:

This option is used to Disable or Enable the system's RAID controller alarm beeper.

Background Task Priority:

The Background Task Priority indicates how much time and system resource the RAID controller devotes to a background task, such as a rebuild operation. The RAID Subsystem allows user to choose the background task priority (High 80%, Medium 50%, Low 25%, and Ultra Low 5%) to balance between background task process and Volume Set access. For high RAID Subsystem performance, specify a low value.

JBOD/RAID Configuration:

The RAID Subsystem supports JBOD and RAID configuration.

SATA NCQ Support:

NCQ is a command protocol in Serial ATA that can only be implemented on native Serial ATA hard drives. It allows multiple commands to be outstanding within a drive at the same time. Drives that support NCQ have an internal queue where outstanding commands can be dynamically rescheduled or re-ordered, along with the necessary tracking mechanisms for outstanding and completed portions of the workload. Disabled or Enable the SATA NCQ function.

HDD Read Ahead Cache:

This option allows the users to disable the cache of the HDDs on the RAID Subsystem. In some HDD models, disabling the cache in the HDD is necessary to prove the RAID Subsystem functions correctly. When Enabled, the drive's read ahead cache algorithm is used, providing maximum performance under most circumstances.

Volume Data Read Ahead:

This option allows the users to set the Volume Data Read Ahead function. Options are: Normal, Aggressive, Conservative, and Disabled.

HDD Queue Depth:

The queue depth is the number of I/O operations that can be run in parallel on a disk drive. This parameter is adjusted the queue depth capacity of NCQ (SATA HDD) or Tagged Command Queuing (SAS HDD) which transmits multiple commands to a single target without waiting for the initial command to complete. HDD Queue Depth options are 1, 2, 4, 8, 16, and 32.

Empty HDD Slot LED

This option allows the users to setup the fault LED light "ON "or "OFF" when there is no HDD installed. When each slot has a power LED for the HDD installed identify, user can set this option to "OFF". Choose option "ON", the RAID controller will light the fault LED; if no HDD installed.

Auto Activate Incomplete Raid

When some of the disk drives are removed in power off state or boot up stage, the RAID set state will change to "Incomplete State". But if a user wants to automatically continue to work while the RAID controller is powered on, the user can set the "Auto Activate Incomplete Raid" option to enable. The RAID state will change to "Degraded Mode" while it powers on.

Disk Write Cache Mode:

The RAID Subsystem supports Disk Write Cache Mode options: Auto, Enabled, and Disabled. If the RAID Subsystem has BBM (battery backup module), selecting the Auto option will automatically enable Disk Write Cache. On the other hand, if there is no BBM, the Auto option will disable Disk Write Cache.

Write Same For Initialization

Drives that support the Write Same feature (SCT) can write to multiple drive sectors at once, improving initialization time. To take advantage of this feature, all the drives in the unit must support "Write Same" command. User can set the "SAS And SATA", "SAS Only", "SATA Only" or "Disabled" for the controller initialization.

Hot Plugged Disk For Rebuilding

It defines if the RAID array volume should start rebuilding or not when detects a disk is inserted/re-inserted during online.

The options are: Blank Disk Only, Always, and Disable. The default is **Blank Disk Only**.

Blank Disk Only: it will trigger the rebuilding if and only if the inserted disk has not been in the RAID array before, which has no RAID signature on it. So when a previously removed disk is self re-inserted, it won't trigger the degraded RAID array to rebuild, and so that the administrator has a chance to identify this misbehaving disk and replaces it.

Always: it is what it was before. Whenever a disk is inserted/ re-inserted whether new or previously existed, it always trigger a rebuilding for the Degraded RAID set/Volume.

Disable: it will not trigger rebuilding regardless what sort of disk plugging in. When **Disable** and/or **Blank Disk Only** is selected, the re-inserted/previously removed disk will be identified as a disk in a separate RAID set with duplicated RAIDset# and with all the rest of RAID members missing.

Disk Capacity Truncation Mode:

The RAID Subsystem uses drive truncation so that drives from different vendors are more likely to be able to be used as spares for each other. Drive truncation slightly decreases the usable capacity of a drive that is used in the subsystem. Options are:

Multiples Of 10G: If you have several 120GB drives from different vendors, chances are that the capacity varies slightly. For example, one drive might be 121.1 GB, and the other 120.4 GB. This drive truncation mode makes the 121.1 GB and 120.4 GB drives same capacity as 120 GB so that one could replace the other.

Multiples Of 1G: If you have 120 GB drives from different vendors, chances are that the capacity varies slightly. For example, one drive might be 121.1 GB, and the other 121.4 GB. This drive truncation mode makes the 121.1 GB and 121.4 GB drives same capacity 121 GB so that one could replace the other.

No Truncation: The capacity of the disk drive is not truncated.

Smart Option For HDD

This option is used to increase the reliability of SSDs/HDDs by automatically copying data from a drive with potential to fail to a designated hot spare or newly inserted drive. The options are: Failed The Drive, Failed The Drive If Hot Spare Exist, and Alert Only. The default is **Alert Only**.

Failed The Drive- controllers kill off the SMART fail drive immediately.

Failed The Drive If Hot Spare Exist – controllers kill off the SMART fail disk if hot spare drive is existed.

Alert Only – it will trigger alert when there happens a SMART failed drive.

Smart Polling Interval

Besides the scheduled volume check, user can define the Smart Pulling Interval to pull the SMART status of each disk. The default is **on demand**. User can schedule every certain period of time interval to pull the SMART status of each disk.

When SMART pulling is executed, disk activity will be temporally halted until the SMART parameter reading is finished. That is why you don't want to set the Interval too frequent. What to use is up to the users to decide based on their applications and experiment results.

5.6.2 Advanced Configuration

To set the RAID system function, move the cursor to the main menu and click the **Advanced Configuration** link. The **Advanced Configuration** menu will show all items, then select the desired function.



NOTE: When you want to change the value on advance configuration screen, please contact your vendor's support engineer for assistance.

Advanced Configurations	
TLER Setting	Default
Timeout Setting	12
Number Of Retries	2
Buffer Threshold Setting	25%
Amount Of Read Ahead	Auto
Read Ahead Count	Auto
Read Ahead Requests	1
Number Of AV Streams	6
Optimize AV Recording	Disabled
Read Performance Margin	No
Write Performance Margin	No
Read And Discard Parity Data	Disabled
Hitachi SATA HDD Speed	Default
WDC SATA HDD Speed	Default
Seagate SATA HDD Speed	Default
End Device Frame Buffering	Enabled
Write Cache Amount	Unified
Save SEDKey In Controller	Enabled
SAS Host Port0 Speed Setting	Auto
SAS Host Port1 Speed Setting	Auto
Fail Disk For Reading Error	3 Errors In 70 Seconds

Confirm The Operation

Submit Reset

TLER Setting

TLER (time-limited error recovery) functions provide support for WD Caviar RE (RAID) series disks. This is a new option from WD to support RAID features that were traditionally missing from standard desktop drives. TLER is a method of signaling the system RAID controller in the event that an error recovery process is taking longer than time-out specifications allow. This prevents the RAID controller from dropping the drive from the array during this period. Default value is manufacture setting. You can select between 5, 6 and 7 second. This feature is to setup the HDD internal timeout value.

Timeout Setting

Disk time-out is a registry setting that defines the time that RAID controller will wait for a hard disk to respond to a command. You can modify the retry value by entering a new value in the edit box beside this button and then selecting the button. Normally you should not need to modify this value. Default value is 12 seconds: You can select between 0.8~120 second.

Number of Retries

This setting determines the number of access that will be attempted before the current command from the RAID controller to the disk drive is aborted. You can modify the retry value by entering a new value in the edit box beside this button and then selecting the button. Normally you should not need to modify this value. There are two selections, either 2 retry or 3 retry.

Buffer Threshold

This new feature there are 4 options; 5%, 25%, 50%, 75%. The percentage represents how much data should be kept in resident cache memory (how full cache should get) before controller starts to flush data onto the hard drives. If the buffer is set for 25%, then all 25% will be cached and is used for writing data. The remaining cache memory will be used for reading and other system overhead. Write buffer threshold for 5% is added for video recording. This option will push data to disk early.

This feature gives controller extra buffer time in case of slow response from the hard drives within a given time. Consequently, this can prevent a pause in data flow and there will be continues data access and stream. This feature is very useful for the video streaming applications where there is high demand for constant non-stop data flow with no interruption due to lower performance of specific hardware.

Amount of Read Ahead

Read-Ahead data is buffered in the RAID controller cache, however, thereby cutting down on the amount of I/O traffic to the disk. The Amount of Read Ahead defines how many data of reading at a time, making more efficient use of the RAID subsystem. This makes it possible to locate and re-issue the data without repetitive hard parsing activities.

The Amount of Read Ahead parameter is used to allocate an amount of memory in the cache memory the frequently executed queries and return the result set back to the host without real disk read execution. Default value is Auto: Controller will base on the HDD number to set the amount of Read Ahead value. You can select between 512KB ~ 32MB.

Read Ahead Count

The Read Ahead count is used to define how many times (1,2, 3,, 10) of the "Amount of Read Ahead X Read Ahead Requests" data reading at a time. Default value is Auto: Controller will base on the HDD number to set the amount of Read Ahead Count value. You can select between Auto, 1, 2,, or 10.

Read Ahead Requests

The Read Ahead Requests is used to define how many times (1, 2, 3) of the "Amount of Read Ahead " data reading at a time. Default value is 1. You can select between 1, 2, or 3.

Number of AV Stream

RAID controllers are required to have not only the function of processing ordinary data but also the function of dealing with AV (audio/video) stream data needing real-time processing. Since the bus cycle used in RAID controller was designed to transfer the computer data exactly, it was unsuitable for the transfer of AV stream needing great band widths. They are required to do some setting for the handshaking during the processing of stream data. This setting is an object of transferring stream data efficiently on an existing RAID controller. Normally you should not need to modify this value. Default value is 6. You can select between 6~256.

To decide how to set AV stream playout parameter, you need to check the Number of Stream, Amount of Read Ahead, and Total Cache Memory during runtime. You can try to adjust the three numbers to get the best performance as your requirement. Number of Stream shows the number of stream added to the system, Amount of Read Ahead shows the amount of Read Ahead data taken from the cache without real disk execution, and total cache memory shows the total available memory being installed in the RAID controller.

Optimize AV Recording

AV recording option is for video recording (no time limit), but if used in normal operation, performance may be degraded. This new feature there are 4 options; Disabled, Mode1, Mode2 and Mode 3. Default value is Disabled. Our controller cache uses LRU method, there have no special memory capacity reserved for read or write. The Mode 1, 2 and 3 are used for define the command sorting method. The default sorting method is helpful for normal applications, but not useful for AV applications, so we have defined three different sorting methods for these special applications. To decide how to optimize AV stream recording parameter, you need to adjust the Optimize AV Recording, and Write Buffer Threshold during runtime.

Read Performance Margin

The "Read Performance Margin" is for controller to reserve n% read margin during AV stream recording. It is designed to eliminate the frame drop and ensure to provide the smooth and stable performance on the application.

Write Performance Margin

The "Write Performance Margin" is for controller to reserve n% write margin AV stream recording.

Subsystem AJA Mode Usage:

1. Controller needs to reboot when you adjust the following settings.
 - (1). Optimize For AV Recording: change any setting
 - (2). Read Performance Margin : No → X%
 - (3). Write Performance Margin : No → X%

2. The following setting is changed for AJA mode, and reboot is required for the setting to take effect.

Setting and Usage			
Optimize AV	Read Margin	Write margin	Description
Mode 3	Any	Any	R/W AJA mode with throttling, no sorting
Mode Disabled/1/2	X%	X%	R/W AJA mode with throttling and sorting
Mode Disabled/1/2	X%	No	Read AJA mode with throttling and sorting
Mode Disabled/1/2	No	X%	Write AJA mode with throttling and sorting

<a>. Under Optimize For AV Recording mode: 3

Read Performance Margin and Write Performance Margin are enabled with "No" setting is 0%, reboot is not required to change Read Performance Margin and Write Performance Margin.

. If Read Performance Margin or Write Performance Margin are changed to X%, reboot is not required to change X% to Y%.

<c>. For NON-VIDEO application, the following setting is recommended
 Buffer Threshold Setting: 25%
 Optimize AV Recording: disabled

Example:

(1). Only write throttling is required

- (a). Buffer Threshold Setting: 5%
- (b). Optimize For AV Recording Mode left unchanged (Disabled)
- (c). Read Performance Margin left unchanged (No)
- (d). Write Performance Margin set to X%
- (e). Reboot
- (f). Adjust Write Performance Margin to fine tune the result (no reboot required)

(2). Read/Write Throttling is required and sorting is to be disabled

- (a). Buffer Threshold Setting: 5%
- (b). Optimize For AV Recording Mode set to 3
- (c). Reboot
- (d). Adjust Read/Write Performance Margin to fine tune the result (no reboot required)

Read And Discard Parity Data

This function is used to determine if parity data is to be read and discarded. It is designed to eliminate the frame drop and ensure to provide the smooth and stable performance on the application.

Hitachi/WDC/Seagate SATA HDD Speed

The purpose of this setting is to provide alternative method to change the interface speed of a SATA HDD speed so that it can be successfully utilized in some compatible condition. Reboot is required for this setting to take effect. Hitachi SATA HDD Speed This function is used to set the Hitachi SATA HDD Speed.

End Device Frame Buffering

Using the 12Gb/s SAS technology, including End Device Frame Buffering (EDFB) technology, the ROC and expander are designed to help ease the industry's transition to 12Gb/s SAS-enabled systems by enabling customers to take advantage of 12Gb/s speeds while using existing 6Gb/s drives and backplane infrastructure. This technology allows the expander to perform aggregation, essentially allowing two devices to share one port on the expander.

Write Cache Amount

The "Write Cache Amount" is for controller to configure how much cache SDRAM dedicated for read, and how much for write. By default (Unified), the size of read or write cache is automatically assigned by the controller firmware. If your server application has significantly more reads than writes or more writes than reads, you might need to change this setting to adjust the read/write cache ratio for improving performance. Reboot is required for the setting to take effect. The optimal ratio setting is application-dependent. The options are as follows: Unified, 5%, 10%, 15%, 20%, 25%, 30%, 35%, 40%, 45%, 50%, 55%, 60%, 65%, 70%, 75%, 80%, 85%, 90%, 95%.

Save SED Key In Controller

<a> If enable → disable, clear SED Key saved in setup

 If disable → enable, if key exists, save to setup

If enable→disable, the key will not remain in the flash. So that next time power up again, it will need to input the key from the CLI again.

SAS Host Port0 / Port1 Speed Setting

The options are as follows: Auto, 6G and 3G

Auto: Set Host Port0 / Port1 Speed to Auto

6G: Set Host Port0 / Port1 Speed to 6G

3G: Set Host Port0 / Port1 Speed to 3G

Fail Disk For Reading Error

This option is available to improve the fail disk function if the disk has too many reading errors. This function is the option that RAID controller will kill off the HDD for reading error account setting value.

- 3 errors in 70 seconds: this option also includes 4 errors in 100 seconds, 5 errors in 120 seconds
- 6 errors in 2 minutes: this option also includes 8 errors in 180 seconds, 10 errors in 240 seconds
- 9 errors in 3 minutes: this option also includes 12 errors in 270 seconds, 15 errors in 360 seconds
- Reading Error Does Not Fail Disk

5.6.3 HDD Power Management

MAID (**M**assive **A**rray of **I**dle **D**isks) is a storage technology that employs a large group of disk drives in which only those drives in active use are spinning at any given time.

This reduces power consumption and prolongs the lives of the drives.

MAID is designed for Write Once, Read Occasionally (WORO) applications such as Data Backup, Document, Mail server, and so on.

MAID technology focuses on "Green Storage Concept" to save power consumption and enhance disk drives effective usage, i.e., "disk drives are spun down when there is no activity or I/O on the drives".

In the RAID subsystem, MAID is implemented in the **HDD Power Management** menu. Using the **Advanced Power Management (APM)** function of disk drives, HDD Power Management has three options (MAID Levels): (Level 1) Place idle drives in Lower Power Mode, where the drives' heads are unloaded; (Level 2) Place idle drives in Low RPM Mode, where drives' heads are unloaded and slows down to around 4000 RPM; and (Level 3) Spin down idle drives, where drives stop spinning and goes into sleep mode.

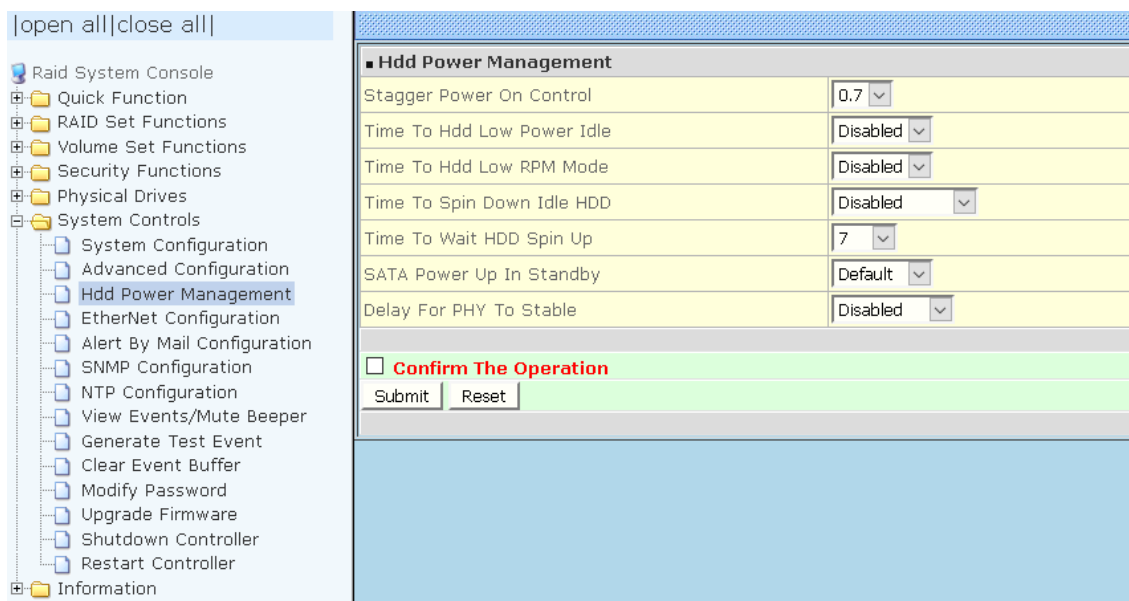

Stagger Power On Control:

This option allows the RAID subsystem's power supply to power up in succession each HDD in the RAID subsystem. In the past, all the HDDs on the RAID subsystem are powered up altogether at the same time. This function allows the power transfer time (lag time) from the last HDD to the next one be set within the range of 0.4 to 6.0 seconds. Default is 0.7 seconds.

Time to HDD Low Power Idle: (MAID Level 1)

This option enables the RAID subsystem to place idle HDDs of a RAID Set in Low Power Mode, where drives' heads are unloaded. The power consumption of the Idle HDD saving is around 15% to 20%. Recovery time is under a second.

Options are: Disabled, 2, 3, 4, 5, 6, 7, 8, 9, 10, 11, 12, 13, 14, and 15 (Minutes).

Time to HDD Low RPM Mode: (MAID Level 2)

This option enables the RAID subsystem to place idle HDDs of a RAID Set in Low RPM Mode, where drives' heads are unloaded and drive platters speed is reduced to around 4000 RPM. The power consumption of the Idle HDD saving is from 35% to 45%. Recovery time is 15 seconds.

Options are: Disabled, 10, 20, 30, 40, 50, and 60 (Minutes).

Time to Spin Down Idle HDD: (MAID Level 3)

This option enables the RAID subsystem to spin down HDDs of a RAID Set after they become idle after a preset period of time. In this level, the drives stop spinning and go into sleep mode. The power consumption of the Idle HDD saving is from 60% to 70%. Recovery time is 30 to 45 seconds.

Options are: Disabled, 1 (For Test), 3, 5, 10, 15, 20, 30, 40, and 60 (Minutes).

Time To Wait HDD Spin Up

This option allows user to set the host system waiting time for HDD spin up. The values can be selected from 7 to 120 seconds.



NOTE: To verify if the disk drive you use supports APM, select RAIDSet Hierarchy and click the disk drive (E# Slot#) link. In the Device Information screen, check the Disk APM Support if "Yes".

SATA Power Up In Standby

SATA Power Up In Standby (power management 2 mode, PM2) is a SATA disk drive configuration which prevents the drive from automatic spinup when power is applied.

Enabled option allows the drive to be powered-up into the Standby power management state to minimize inrush current at power-up and to allow the controller to sequence the spinup of devices. It is mainly for server/workstation environments operating in multiple-drive configurations.

Delay for Phy to Stable

This function is used to increase the availability of the HDD unpredictable behavior. Delay timing can be set from 10 to 50 seconds, indicating the time that the controller waits, from the startup of the system until the hard drive is being detected. The default is **Disabled**.

5.6.4 EtherNet Configuration

To set the Ethernet configuration, click the **EtherNet Configuration** link under the System Controls menu. The EtherNet Configuration screen will be shown. Set the desired configuration. Once done, tick on the **Confirm The Operation** and click the **Submit** button to save the settings.

[open all][close all]

- Raid System Console
- Quick Function
- RAID Set Functions
- Volume Set Functions
- Security Functions
- Physical Drives
- System Controls
 - System Configuration
 - Advanced Configuration
 - Hdd Power Management
 - EtherNet Configuration**
 - Alert By Mail Configuration
 - SNMP Configuration
 - NTP Configuration
 - View Events/Mute Beeper
 - Generate Test Event
 - Clear Event Buffer
 - Modify Password
 - Upgrade Firmware
 - Shutdown Controller
 - Restart Controller
- Information

Ether Net Configurations				
DHCP Function	Disabled			
Local IP Address (Used If DHCP Disabled)	192	168	15	198
Gateway IP Address (Used If DHCP Disabled)	192	168	1	1
Subnet Mask (Used If DHCP Disabled)	255	255	255	0
HTTP Port Number (7168..8191 Is Reserved)	80			
Telnet Port Number (7168..8191 Is Reserved)	23			
SMTP Port Number (7168..8191 Is Reserved)	25			
Current IP Address	192.168.15.198			
Current Gateway IP Address	192.168.1.1			
Current Subnet Mask	255.255.255.0			
Ether Net MAC Address	00.1B.4D.02.7F.4F			
<input type="checkbox"/> Confirm The Operation				
<input type="button" value="Submit"/> <input type="button" value="Reset"/>				



NOTE: If HTTP, Telnet and SMTP Port Number is set to "0", the service is disabled.

5.6.5 Alert By Mail Configuration

To set the Event Notification function, click on the **Alert By Mail Configuration** link under the System Controls menu. The Event Notification configuration screen will be shown. Set up the desired function and option. When an abnormal condition occurs, an error message will be emailed to the email recipient(s) that a problem has occurred. Events are classified into 4 levels (Urgent, Serious, Warning, and Information).

open all close all																																																											
<ul style="list-style-type: none"> Raid System Console Quick Function RAID Set Functions Volume Set Functions Security Functions Physical Drives System Controls <ul style="list-style-type: none"> System Configuration Advanced Configuration Hdd Power Management EtherNet Configuration Alert By Mail Configuration SNMP Configuration NTP Configuration View Events/Mute Beeper Generate Test Event Clear Event Buffer Modify Password Upgrade Firmware Shutdown Controller Restart Controller Information 	<table border="1"> <tr> <td colspan="2">SMTP Server Configuration</td> </tr> <tr> <td>SMTP Server IP Address</td> <td>0 . 0 . 0 . 0</td> </tr> <tr> <td colspan="2">Mail Address Configurations</td> </tr> <tr> <td>Sender Name :</td> <td>Mail Address :</td> </tr> <tr> <td>Account :</td> <td>Password :</td> </tr> <tr> <td colspan="2">Event Notification Configurations</td> </tr> <tr> <td>MailTo Name1 :</td> <td>Mail Address :</td> </tr> <tr> <td><input checked="" type="radio"/> Disable Event Notification</td> <td>No Event Notification Will Be Sent</td> </tr> <tr> <td><input type="radio"/> Urgent Error Notification</td> <td>Send Only Urgent Event</td> </tr> <tr> <td><input type="radio"/> Serious Error Notification</td> <td>Send Urgent And Serious Event</td> </tr> <tr> <td><input type="radio"/> Warning Error Notification</td> <td>Send Urgent, Serious And Warning Event</td> </tr> <tr> <td><input type="radio"/> Information Notification</td> <td>Send All Event</td> </tr> <tr> <td><input type="checkbox"/> Notification For No Event</td> <td>Notify User If No Event Occurs Within 24 Hours</td> </tr> <tr> <td>MailTo Name2 :</td> <td>Mail Address :</td> </tr> <tr> <td><input checked="" type="radio"/> Disable Event Notification</td> <td>No Event Notification Will Be Sent</td> </tr> <tr> <td><input type="radio"/> Urgent Error Notification</td> <td>Send Only Urgent Event</td> </tr> <tr> <td><input type="radio"/> Serious Error Notification</td> <td>Send Urgent And Serious Event</td> </tr> <tr> <td><input type="radio"/> Warning Error Notification</td> <td>Send Urgent, Serious And Warning Event</td> </tr> <tr> <td><input type="radio"/> Information Notification</td> <td>Send All Event</td> </tr> <tr> <td><input type="checkbox"/> Notification For No Event</td> <td>Notify User If No Event Occurs Within 24 Hours</td> </tr> <tr> <td>MailTo Name3 :</td> <td>Mail Address :</td> </tr> <tr> <td><input checked="" type="radio"/> Disable Event Notification</td> <td>No Event Notification Will Be Sent</td> </tr> <tr> <td><input type="radio"/> Urgent Error Notification</td> <td>Send Only Urgent Event</td> </tr> <tr> <td><input type="radio"/> Serious Error Notification</td> <td>Send Urgent And Serious Event</td> </tr> <tr> <td><input type="radio"/> Warning Error Notification</td> <td>Send Urgent, Serious And Warning Event</td> </tr> <tr> <td><input type="radio"/> Information Notification</td> <td>Send All Event</td> </tr> <tr> <td><input type="checkbox"/> Notification For No Event</td> <td>Notify User If No Event Occurs Within 24 Hours</td> </tr> <tr> <td>MailTo Name4 :</td> <td>Mail Address :</td> </tr> <tr> <td><input checked="" type="radio"/> Disable Event Notification</td> <td>No Event Notification Will Be Sent</td> </tr> </table>	SMTP Server Configuration		SMTP Server IP Address	0 . 0 . 0 . 0	Mail Address Configurations		Sender Name :	Mail Address :	Account :	Password :	Event Notification Configurations		MailTo Name1 :	Mail Address :	<input checked="" type="radio"/> Disable Event Notification	No Event Notification Will Be Sent	<input type="radio"/> Urgent Error Notification	Send Only Urgent Event	<input type="radio"/> Serious Error Notification	Send Urgent And Serious Event	<input type="radio"/> Warning Error Notification	Send Urgent, Serious And Warning Event	<input type="radio"/> Information Notification	Send All Event	<input type="checkbox"/> Notification For No Event	Notify User If No Event Occurs Within 24 Hours	MailTo Name2 :	Mail Address :	<input checked="" type="radio"/> Disable Event Notification	No Event Notification Will Be Sent	<input type="radio"/> Urgent Error Notification	Send Only Urgent Event	<input type="radio"/> Serious Error Notification	Send Urgent And Serious Event	<input type="radio"/> Warning Error Notification	Send Urgent, Serious And Warning Event	<input type="radio"/> Information Notification	Send All Event	<input type="checkbox"/> Notification For No Event	Notify User If No Event Occurs Within 24 Hours	MailTo Name3 :	Mail Address :	<input checked="" type="radio"/> Disable Event Notification	No Event Notification Will Be Sent	<input type="radio"/> Urgent Error Notification	Send Only Urgent Event	<input type="radio"/> Serious Error Notification	Send Urgent And Serious Event	<input type="radio"/> Warning Error Notification	Send Urgent, Serious And Warning Event	<input type="radio"/> Information Notification	Send All Event	<input type="checkbox"/> Notification For No Event	Notify User If No Event Occurs Within 24 Hours	MailTo Name4 :	Mail Address :	<input checked="" type="radio"/> Disable Event Notification	No Event Notification Will Be Sent
SMTP Server Configuration																																																											
SMTP Server IP Address	0 . 0 . 0 . 0																																																										
Mail Address Configurations																																																											
Sender Name :	Mail Address :																																																										
Account :	Password :																																																										
Event Notification Configurations																																																											
MailTo Name1 :	Mail Address :																																																										
<input checked="" type="radio"/> Disable Event Notification	No Event Notification Will Be Sent																																																										
<input type="radio"/> Urgent Error Notification	Send Only Urgent Event																																																										
<input type="radio"/> Serious Error Notification	Send Urgent And Serious Event																																																										
<input type="radio"/> Warning Error Notification	Send Urgent, Serious And Warning Event																																																										
<input type="radio"/> Information Notification	Send All Event																																																										
<input type="checkbox"/> Notification For No Event	Notify User If No Event Occurs Within 24 Hours																																																										
MailTo Name2 :	Mail Address :																																																										
<input checked="" type="radio"/> Disable Event Notification	No Event Notification Will Be Sent																																																										
<input type="radio"/> Urgent Error Notification	Send Only Urgent Event																																																										
<input type="radio"/> Serious Error Notification	Send Urgent And Serious Event																																																										
<input type="radio"/> Warning Error Notification	Send Urgent, Serious And Warning Event																																																										
<input type="radio"/> Information Notification	Send All Event																																																										
<input type="checkbox"/> Notification For No Event	Notify User If No Event Occurs Within 24 Hours																																																										
MailTo Name3 :	Mail Address :																																																										
<input checked="" type="radio"/> Disable Event Notification	No Event Notification Will Be Sent																																																										
<input type="radio"/> Urgent Error Notification	Send Only Urgent Event																																																										
<input type="radio"/> Serious Error Notification	Send Urgent And Serious Event																																																										
<input type="radio"/> Warning Error Notification	Send Urgent, Serious And Warning Event																																																										
<input type="radio"/> Information Notification	Send All Event																																																										
<input type="checkbox"/> Notification For No Event	Notify User If No Event Occurs Within 24 Hours																																																										
MailTo Name4 :	Mail Address :																																																										
<input checked="" type="radio"/> Disable Event Notification	No Event Notification Will Be Sent																																																										



NOTE: If Event Notification by email is enabled, every 30 of event log will be sent to the email recipient(s) as one package log.

NOTE: If different email recipients are setup, the event notification levels for each email recipient can be configured differently. For example, first email recipient can be configured with "Urgent Error Notification" while second email recipient can be configured with "Serious Error Notification".

5.6.6 SNMP Configuration

The SNMP gives users independence from the proprietary network management schemes of some manufacturers and SNMP is supported by many WAN and LAN manufacturers enabling true LAN/ WAN management integration.

To set the SNMP function, move the cursor to the main menu and click on the **SNMP Configuration** link. The SNMP Configurations screen will be shown. Select the desired function and set the preferred option.

open all | close all |

- Raid System Console
 - Quick Function
 - RAID Set Functions
 - Volume Set Functions
 - Security Functions
 - Physical Drives
 - System Controls
 - System Configuration
 - Advanced Configuration
 - Hdd Power Management
 - EtherNet Configuration
 - Alert By Mail Configuration
 - SNMP Configuration**
 - NTP Configuration
 - View Events/Mute Beeper
 - Generate Test Event
 - Clear Event Buffer
 - Modify Password
 - Upgrade Firmware
 - Shutdown Controller
 - Restart Controller
 - Information

■ SNMP Trap Configurations			
SNMP Trap IP Address #1	0 . 0 . 0 . 0	Port#	162
SNMP Trap IP Address #2	0 . 0 . 0 . 0	Port#	162
SNMP Trap IP Address #3	0 . 0 . 0 . 0	Port#	162

■ SNMP System Configurations	
Community	
sysContact.0	
sysName.0	
sysLocation.0	

■ SNMP Trap Notification Configurations	
<input checked="" type="radio"/> Disable SNMP Trap	No SNMP Trap Will Be Sent
<input type="radio"/> Urgent Error Notification	Send Only Urgent Event
<input type="radio"/> Serious Error Notification	Send Urgent And Serious Event
<input type="radio"/> Warning Error Notification	Send Urgent, Serious And Warning Event
<input type="radio"/> Information Notification	Send All Event

Confirm The Operation

Submit Reset

SNMP Trap Configurations: Type in the SNMP Trap IP Address box the IP address of the host system where SNMP traps will be sent. The SNMP Port is set to 162 by default.

SNMP System Configuration:

Community: Type the SNMP community. The default is public.

(1) **sysContact.0**, (2) **sysLocation.0**, and (3) **sysName.0**: SNMP parameter (31 bytes max). If these 3 categories are configured and when an event occurs, SNMP will send out a message that includes the 3 categories within the message. This allows user to easily define which RAID unit is having problem.

SNMP Trap Notification Configurations: Select the desired option.

After completing the settings, tick on the **Confirm The Operation** and click on the **Submit** button to save the configuration.

SNMP also works in the same as Alert By Mail when sending event notifications.

5.6.7 NTP Configuration

NTP stands for **Network Time Protocol**. It is an Internet protocol used to synchronize the clocks of computers to some time reference. Type the NTP Server IP Address to enable the RAID Subsystem to synchronize with it.

To set the NTP function, move the cursor to the main menu and click on the **NTP Configuration** link. The NTP Configuration screen will be displayed. Select the desired function and configure the necessary option.

After completing the settings, tick on the **Confirm The Operation** and click on the **Submit** button to save the configuration.

The screenshot shows the RAID System Console interface. On the left is a tree view of system controls, with 'NTP Configuration' selected. The main panel displays the following configuration options:

- NTP Server Configurations**
 - NTP Server IP Address #1: [0].[0].[0].[0]
 - NTP Server IP Address #2: [0].[0].[0].[0]
- Time Zone Configuration**
 - Time Zone: (GMT+08:00)Taipei
 - Automatic Daylight Saving: Enabled
 - Current Time: 2017/3/30 15:41
 - NTP Server Not Set
- Confirm The Operation**
- Submit | Reset

5.6.9 Generate Test Event

If you want to generate test events, move the cursor bar to the main menu and click on the **Generate Test Event** Link. Tick on the **Confirm The Operation** and click on the **Submit** button. Then click on the **View Events/Mute Beeper** to view the test event.

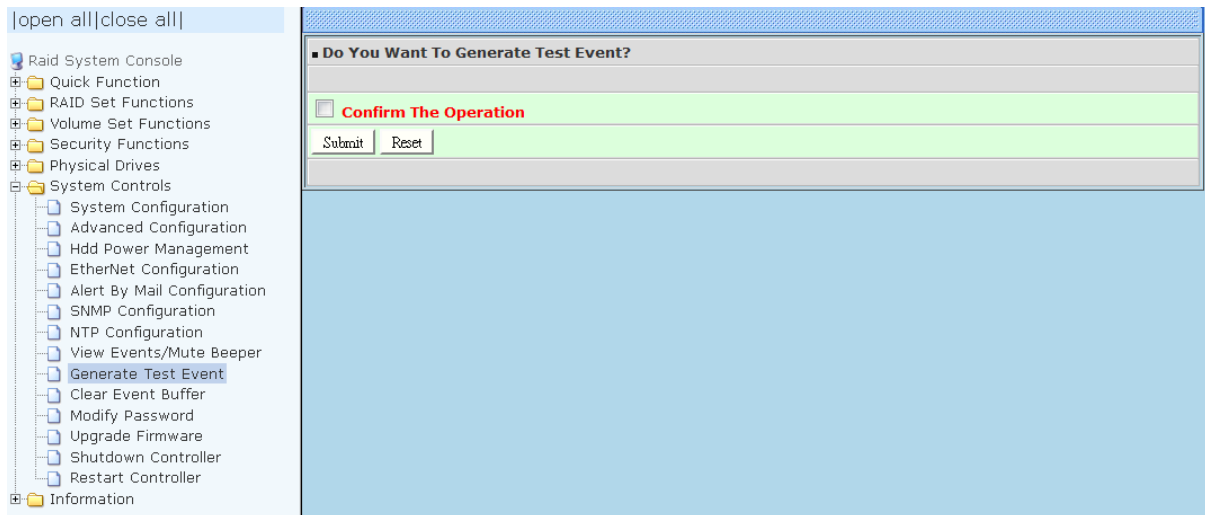

5.6.10 Clear Event Buffer

Use this feature to clear the RAID Subsystem's System Events Information buffer.

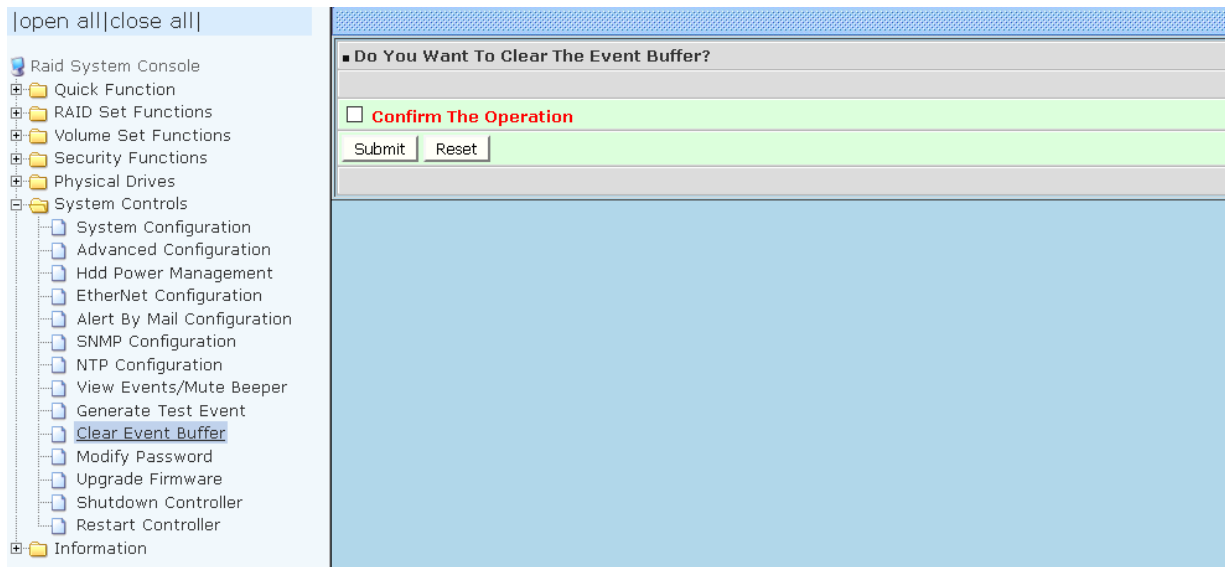

5.6.11 Modify Password

To change or disable the RAID Subsystem's admin password, click on the **Modify Password** link under the **System Controls** menu. The Modify System Password screen appears.

The factory-default admin password is set to **00000000**. Once the password has been set, the user or administrator can only monitor and configure the RAID Subsystem by providing the correct password.

The password is used to protect the RAID Subsystem's configuration from unauthorized access. The RAID controller will check the password only when entering the Main Menu from the initial screen. The RAID Subsystem will automatically go back to the initial screen when it does not receive any command after sometime.

To disable the password, enter only the original password in the **Enter Original Password** box, and leave both the **Enter New Password** and **Re-Enter New Password** boxes blank. After selecting the **Confirm The Operation** option and clicking the **Submit** button, the system password checking will be disabled. No password checking will occur when entering the main menu from the starting screen.

The screenshot shows the RAID System Console interface. On the left is a navigation tree with 'System Controls' expanded to 'Modify Password'. The main content area is titled 'Modify System Password' and contains three input fields: 'Enter Original Password', 'Enter New Password', and 'Re-Enter New Password'. Below these fields is a green bar with a checkbox labeled 'Confirm The Operation' and two buttons: 'Submit' and 'Reset'.



NOTE: The admin Password characters allowed are 'A' – 'Z', 'a' – 'z', and '0' – '9'. The minimum number of Password characters is null/empty (Password is disabled) and maximum number of Password characters is 15.

5.6.12 Upgrade Firmware

Please refer to Section 6.2 for more information.

5.6.13 Shutdown Controller

Use this function to shutdown the RAID Controller. This is used to flush the data from the cache memory, and is normally done before powering off the system power switch.

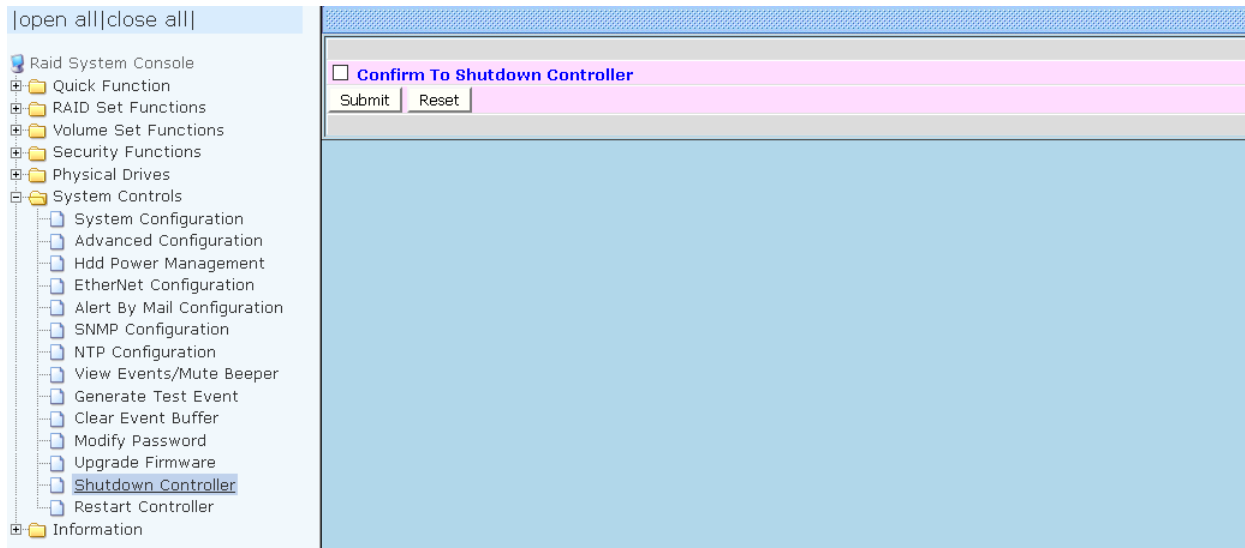

5.6.14 Restart Controller

Use this function to restart the RAID Controller.



5.7 Information Menu

5.7.1 RAID Set Hierarchy

Use this feature to view the RAID subsystem's existing Raid Set(s), Volume Set(s) and disk drive(s) configuration and information. Select the **RAID Set Hierarchy** link from the **Information** menu to display the Raid Set Hierarchy screen.

■ RAID Set Hierarchy				
RAID Set	Devices	Volume Set(Port/Lun)	Volume State	Capacity
Raid Set # 000	E#1Slot#1	Volume---VOL#000(0&2/0)	Normal	2199.0GB
	E#1Slot#2			
	E#1Slot#3			

■ Enclosure#1 : SAS RAID Subsystem V1.0			
Device	Usage	Capacity	Model
Slot#1(A)	Raid Set # 000	1200.2GB	HGST HUC101212CSS600
Slot#2(B)	Raid Set # 000	1200.2GB	HGST HUC101212CSS600
Slot#3(C)	Raid Set # 000	1200.2GB	HGST HUC101212CSS600
Slot#4(D)	Free	1200.2GB	HGST HUC101212CSS600
Slot#5(E)	Free	1200.2GB	HGST HUC101212CSS600
Slot#6(F)	Free	1200.2GB	HGST HUC101212CSS600
Slot#7(10)	Free	1200.2GB	HGST HUC101212CSS600
Slot#8(11)	Free	1200.2GB	HGST HUC101212CSS600
Slot#9(12)	Free	1200.2GB	HGST HUC101212CSS600
Slot#10(13)	Free	1200.2GB	HGST HUC101212CSS600
Slot#11(14)	Free	1200.2GB	HGST HUC101212CSS600
Slot#12(15)	Free	1200.2GB	HGST HUC101212CSS600
Slot#13(16)	Free	1200.2GB	HGST HUC101212CSS600
Slot#14(17)	Free	1200.2GB	HGST HUC101212CSS600
Slot#15(18)	Free	1200.2GB	HGST HUC101212CSS600
Slot#16(19)	Free	1200.2GB	HGST HUC101212CSS600

To view the Raid Set information, click the **Raid Set #** link from the Raid Set Hierarchy screen. The Raid Set Information screen appears.

■ Raid Set Information	
Raid Set Name	Raid Set # 000
Member Disks	4
Total Raw Capacity	4800.0GB
Free Raw Capacity	0.1GB
Min Member Disk Size	1200.0GB
Supported Volumes	128
Raid Set Power State	Operating
Security Status	N/A
Raid Set State	Initializing

Raid Set Power State has Operation and Spin down.

Raid Set State has Normal mode, Degraded mode and Incomplete mode.

To view the disk drive information, click the **E# Slot#** link from the Raid Set Hierarchy screen. The Disk Information screen appears. This screen shows various information such as timeout count, media error count, and SMART information.

■ Device Information	
Device Type	SAS(5000CCA0350111DE)
Device Location	Enclosure#1 Slot#1
Model Name	HGST HUC101830CSS200
Serial Number	02V0L7DK
Firmware Rev.	A380
Disk Capacity	300.1GB
Physical Block Size	512
Logical Block Size	512
Current SAS Mode	12G
Supported SAS Mode	12G
Device State	Normal
Security Capability	Cryptographic Erase
Security State	N/A
Timeout Count	0
Media Error Count	0
Hdd Xfer Speed	Show Result
Rotation Speed	10520(RPM)
Device Temperature	38 °C
Read Errors Recovered W/O Delay	0x0000000000000000
Read Errors Recovered W Delay	0x0000000000000019
Read Errors Recovered W Retry	0x0000000000000000
Read Errors Recovered	0x0000000000000019
Read Total Bytes	0x0001F2CE1D68EA00
Read Errors Unrecovered	0x0000000000000000
Write Errors Recovered W/O Delay	0x0000000000000000
Write Errors Recovered W Delay	0x0000000000000000
Write Errors Recovered W Retry	0x0000000000000000
Write Errors Recovered	0x0000000000000000
Write Total Bytes	0x0000E30D0FE87C00
Write Errors Unrecovered	0x0000000000000000
Verify Errors Recovered W/O Delay	0x0000000000000000
Verify Errors Recovered W Delay	0x0000000000000000
Verify Errors Recovered W Retry	0x0000000000000000
Verify Errors Recovered	0x0000000000000000
Verify Errors Unrecovered	0x0000000000000000
Non-Medium Errors	0x0000000000000000
Defect PList Block Count	0x00000000000056DE
Defect GList Block Count	0x0000000000000000
Device Smart Status	O.K.

5.7.1.1 Hdd Xfer Speed

“Hdd Xfer Speed” is a firmware-level hard disk / SSD speed function that is used to measure the drive’s performance. “Hdd Xfer Speed” will perform read tests without overwriting customer data. The read-only palimpsest benchmark of the disk is shown in the device information. If the value drops below the normal curve, something may be wrong with the disk. User can use “Set Disk To Be Failed” function from remote side to set a slow speed disk as “failed” so that volume will be not stuck by the slow speed disk after rebuild.

"Hdd Xfer Speed" result can be accessed by clicking on the "Device" from the "RAID set Hierarchy" you wish to scan, clicking on the "Show Result". This allows you to set up a scan environment which runs the test by clicking "Test Disk Speed" on the right screen setup option. If more than one drive is checked when you set the 'Disks To Be Tested', it will run that test for the number setting drives.

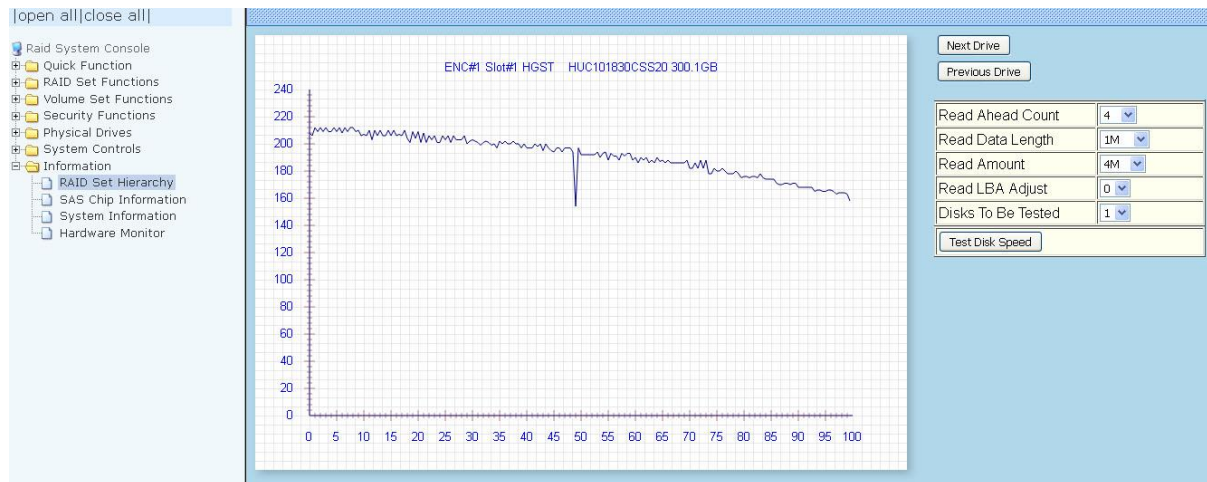

If there's a certain location in the hard drive that is getting poor performance, hard drive read benchmarks can help confirm this. Above is a screenshot of a palimpsest benchmark on a hard drive. The length time of firmware takes to complete the drive test depends on its size.

To view the Volume Set information, click the **Volume---VOL#** link from the Raid Set Hierarchy screen. The Volume Set Information screen appears.

The screenshot shows the 'Volume Set Information' screen in the RAID System Console. The left sidebar shows the navigation tree with 'RAID Set Hierarchy' selected. The main area displays a table with the following information:

Volume Set Information	
Volume Set Name	Volume---VOL#000
Raid Set Name	Raid Set # 000
Volume Capacity	200.0GB
SAS Port/Lun	08&2/0
Raid Level	Raid 5
Stripe Size	64KBytes
Block Size	512Bytes
Member Disks	4
Cache Mode	Write Back
Write Protection	Disabled
Tagged Queuing	Enabled
Volume State	Normal

Volume State has Normal mode, Degraded mode, Initializing mode (Foreground or Background), Rebuilding mode, Checking mode, Migrating mode, Cloning and Failed mode.

5.7.2 SAS Chip Information

To view the SAS Chip Information of the RAID Controller, click the link SAS Chip Information.

open all | close all

- 📁 RAID System Console
- 📁 Quick Function
- 📁 RAID Set Functions
- 📁 Volume Set Functions
- 📁 Security Functions
- 📁 Physical Drives
- 📁 System Controls
- 📁 Information
 - 📁 RAID Set Hierarchy
 - 📁 SAS Chip Information
 - 📁 System Information
 - 📁 Hardware Monitor

■ Controller: xxxxxxxx 1.54	
SAS Address	5001B4D027F4F000
Enclosure	
Number Of Phys	8
Attached Expander	Expander#1[5001B4D51E3FC03F][8x12G]
■ Expander# 1:SAS3 E SAS3CE 01.30.5F0130	
SAS Address	5001B4D51E3FC03F
Component Vendor	LSI
Component ID	0233
Enclosure	ENC#1
Number Of Phys	39
Attached Expander	Controller[5001B4D027F4F000][8x12G]

The SAS Address, Component Vendor, Component ID, Enclosure number, Number of Phys, and Attached Expander information will be shown.

User can click on controller and SAS expander # item on the "SAS Chip Information" screen. It will show statistic page for ports on the controller and SAS expander#.



NOTE: First to refresh of the fully statistic page by ticking the "Clear Error Log" option.

open all | close all

- 📁 RAID System Console
- 📁 Quick Function
- 📁 RAID Set Functions
- 📁 Volume Set Functions
- 📁 Security Functions
- 📁 Physical Drives
- 📁 System Controls
- 📁 Information
 - 📁 RAID Set Hierarchy
 - 📁 SAS Chip Information
 - 📁 System Information
 - 📁 Hardware Monitor

■ Expander# 1:SAS3 E SAS3CE 01.30.5F0130 [Clear Error Log]									
Phy	Attached Sas Addr	Attached Sas Phy	Attached Device	Link Rate	Attribute	Invalid Dword	Disparity Error	Lost Sync	Reset Problem
Phy00	N/A	N/A	N/A	Not Linked	T	00000000	00000000	00000000	00000000
Phy01	5000039638217057	01	ENC#1Slot#2	12G	T	00000000	00000000	00000000	00000000
Phy02	N/A	N/A	N/A	Not Linked	T	00000000	00000000	00000000	00000000
Phy03	5000039638217278	01	ENC#1Slot#4	12G	T	00000000	00000000	00000000	00000000
Phy04	N/A	N/A	N/A	Not Linked	T	00000000	00000000	00000000	00000000
Phy05	5000039638217327	01	ENC#1Slot#6	12G	T	00000000	00000000	00000000	00000000
Phy06	N/A	N/A	N/A	Not Linked	T	00000000	00000000	00000000	00000000
Phy07	5000039638217383	01	ENC#1Slot#8	12G	T	00000000	00000000	00000000	00000000
Phy08	N/A	N/A	N/A	Not Linked	I	00000000	00000000	00000000	00000000
Phy09	N/A	N/A	N/A	Not Linked	T	00000000	00000000	00000000	00000000
Phy10	N/A	N/A	N/A	Not Linked	T	00000000	00000000	00000000	00000000
Phy11	N/A	N/A	N/A	Not Linked	T	00000000	00000000	00000000	00000000
Phy12	N/A	N/A	N/A	Not Linked	T	00000000	00000000	00000000	00000000
Phy13	N/A	N/A	N/A	Not Linked	T	00000000	00000000	00000000	00000000
Phy14	N/A	N/A	N/A	Not Linked	T	00000000	00000000	00000000	00000000
Phy15	N/A	N/A	N/A	Not Linked	T	00000000	00000000	00000000	00000000
Phy16	5001B4D027F4F000	00	Controller	12G	S	00000000	00000000	00000000	00000000
Phy17	5001B4D027F4F000	01	Controller	12G	S	00000000	00000000	00000000	00000000
Phy18	5001B4D027F4F000	02	Controller	12G	S	00000000	00000000	00000000	00000000
Phy19	5001B4D027F4F000	03	Controller	12G	S	00000000	00000000	00000000	00000000
Phy20	5001B4D027F4F000	04	Controller	12G	S	00000000	00000000	00000000	00000000
Phy21	5001B4D027F4F000	05	Controller	12G	S	00000000	00000000	00000000	00000000

5.7.3 System Information

To view the RAID subsystem's controller information, click the **System Information** link from the **Information** menu. The Raid Subsystem Information screen appears.

The screenshot shows a web interface with a left-hand navigation menu and a main content area. The navigation menu includes options like 'Raid System Console', 'Quick Function', 'RAID Set Functions', 'Volume Set Functions', 'Security Functions', 'Physical Drives', 'System Controls', and 'Information'. Under 'Information', 'System Information' is selected. The main content area displays two sections: 'Controller#2 System Information' and 'Controller#1 System Information'. Each section contains a table of system parameters such as Controller Name, Firmware Version, BOOT ROM Version, PL Firmware Version, Serial Number, Unit Serial #, Main Processor, CPU ICACHE Size, CPU DCACHE Size, CPU SCACHE Size, System Memory, Current IP Address, SAS Address, SAS Port0 Link Status, SAS Port1 Link Status, and Dual Controller State.

Controller#2 System Information	
Controller Name	
Firmware Version	V1.54 2016-11-23
BOOT ROM Version	V1.54 2016-11-23
PL Firmware Version	13.0.0.0
Serial Number	A639EHGBPR800009
Unit Serial #	
Main Processor	1.2GHz PPC476 RevC0
CPU ICACHE Size	32KBytes
CPU DCACHE Size	32KBytes/Write Through
CPU SCACHE Size	512KBytes/Write Back
System Memory	4096MB/1866MHz/ECC
Current IP Address	192.168.15.198
SAS Address	5001B4D027F4F800
SAS Port0 Link Status	4x1200MB/Sec
SAS Port1 Link Status	Not Linked
Dual Controller State	Dual Operational

Controller#1 System Information	
Controller Name	
Firmware Version	V1.54 2016-11-23
BOOT ROM Version	V1.54 2016-11-23
PL Firmware Version	13.0.0.0
Serial Number	A648EHGBPR800013
Unit Serial #	
Main Processor	1.2GHz PPC476 RevC0
CPU ICACHE Size	32KBytes
CPU DCACHE Size	32KBytes/Write Through
CPU SCACHE Size	512KBytes/Write Back
System Memory	4096MB/1866MHz/ECC
Current IP Address	192.168.15.197
SAS Address	5001B4D028282800
SAS Port0 Link Status	4x1200MB/Sec

The Controller Name, Firmware Version, BOOT ROM Version, PL Firmware Version, Serial Number, Unit Serial #, Main Processor, CPU ICACHE size, CPU DCACHE size, CPU SCACHE Size, System Memory, Current IP Address, SAS Address, SAS Port0 Link Status, SAS Port1 Link Status, and Dual Controller State appear in this screen.

The following are the states under Dual Controller State:

Dual Controller State	Description
Single	Controller is running at Single Mode.
Other Controller Added	The other Controller is added and waiting to start.
Other Controller Booting	The other Controller is starting up.
Other Controller Ready	The other Controller has booted up and ready.
Other Controller Failed	The other Controller is Failed.
Sync Controller State	The two Controllers are synchronizing their configuration or state.
Sync Controller Cache	The two Controllers are synchronizing the data in their cache memory.
Dual Operational	The Controller is running.
Initialize	The boot up state when Dual Controller starts up.

5.7.4 Hardware Monitor

To view the RAID subsystem's hardware information, click the **Hardware Monitor** link from the **Information** menu. The Hardware Monitor Information screen appears.

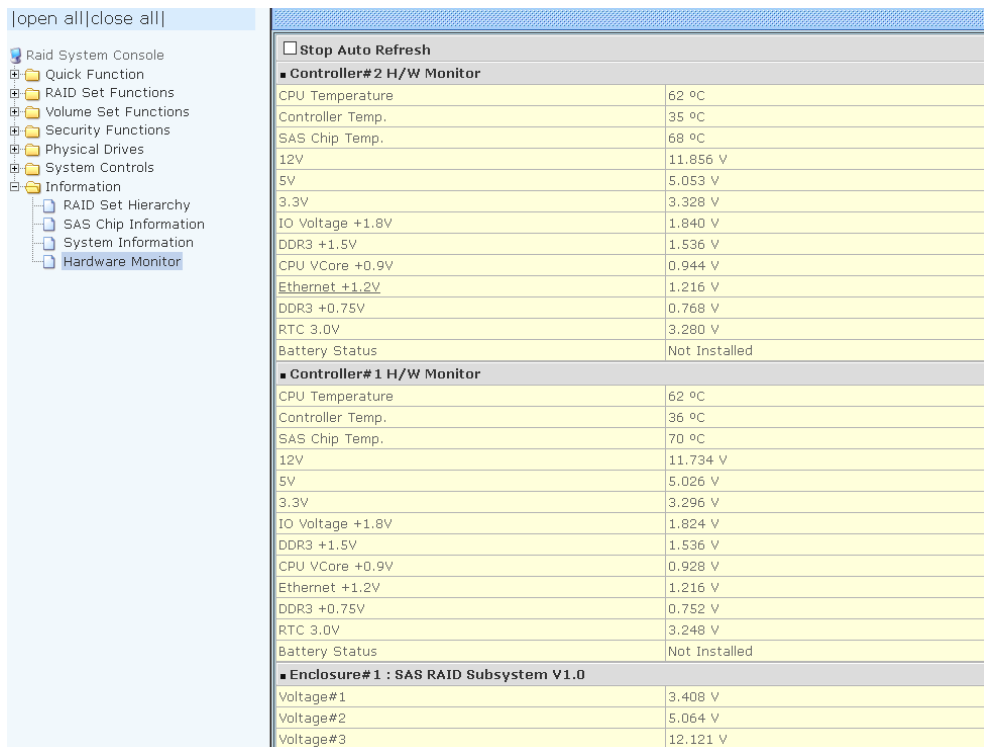

Controller#2 H/W Monitor	
CPU Temperature	62 °C
Controller Temp.	35 °C
SAS Chip Temp.	68 °C
12V	11.856 V
5V	5.053 V
3.3V	3.328 V
IO Voltage +1.8V	1.840 V
DDR3 +1.5V	1.536 V
CPU VCore +0.9V	0.944 V
Ethernet +1.2V	1.216 V
DDR3 +0.75V	0.768 V
RTC 3.0V	3.280 V
Battery Status	Not Installed

Controller#1 H/W Monitor	
CPU Temperature	62 °C
Controller Temp.	36 °C
SAS Chip Temp.	70 °C
12V	11.734 V
5V	5.026 V
3.3V	3.296 V
IO Voltage +1.8V	1.824 V
DDR3 +1.5V	1.536 V
CPU VCore +0.9V	0.928 V
Ethernet +1.2V	1.216 V
DDR3 +0.75V	0.752 V
RTC 3.0V	3.248 V
Battery Status	Not Installed

Enclosure#1 : SAS RAID Subsystem V1.0	
Voltage#1	3.408 V
Voltage#2	5.064 V
Voltage#3	12.121 V



NOTE: To disable auto refresh of GUI, tick the “Stop Auto Refresh” option.

The following are the states of Battery Backup Module(BBM):

State	Description
Not Installed	BBM is not installed
xx%	The percentage of battery remaining
Charged(100%)	BBM is completely charged
Failed	BBM is Failed.



NOTE: If you want to install the Battery Backup Module(BBM) and running in dual controller mode, please make sure BBM are installed on both controllers. Failing to do so will result in controller malfunction, an error message “Battery Flag Mismatch” will also appear on the event log.

The RAID subsystem's hardware information with Flash-based Backup module(FBM).

[open all][close all]																																																													
<ul style="list-style-type: none"> Raid System Console Quick Function RAID Set Functions Volume Set Functions Security Functions Physical Drives System Controls Information <ul style="list-style-type: none"> RAID Set Hierarchy SAS Chip Information System Information Hardware Monitor 	<div style="border: 1px solid #ccc; padding: 5px;"> <input type="checkbox"/> Stop Auto Refresh Controller# 1 H/W Monitor <table border="1" style="width: 100%; border-collapse: collapse;"> <tr><td>CPU Temperature</td><td>62 °C</td></tr> <tr><td>Controller Temp.</td><td>35 °C</td></tr> <tr><td>SAS Chip Temp.</td><td>65 °C</td></tr> <tr><td>12V</td><td>11.734 V</td></tr> <tr><td>5V</td><td>4.999 V</td></tr> <tr><td>3.3V</td><td>3.296 V</td></tr> <tr><td>IO Voltage +1.8V</td><td>1.824 V</td></tr> <tr><td>DDR3 +1.5V</td><td>1.536 V</td></tr> <tr><td>CPU VCore +0.9V</td><td>0.928 V</td></tr> <tr><td>Ethernet +1.2V</td><td>1.216 V</td></tr> <tr><td>DDR3 +0.75V</td><td>0.752 V</td></tr> <tr><td>RTC 3.0V</td><td>3.248 V</td></tr> <tr><td>Flash/Battery Module</td><td>Charging(3.819V)</td></tr> <tr><td>Module Power Cycles</td><td>206</td></tr> <tr><td>Module Power On Hours</td><td>3702</td></tr> <tr><td>Module Temperature</td><td>45</td></tr> <tr><td>Module Charge Counts</td><td>12</td></tr> </table> Controller# 2 H/W Monitor <table border="1" style="width: 100%; border-collapse: collapse;"> <tr><td>CPU Temperature</td><td>54 °C</td></tr> <tr><td>Controller Temp.</td><td>33 °C</td></tr> <tr><td>SAS Chip Temp.</td><td>54 °C</td></tr> <tr><td>12V</td><td>11.856 V</td></tr> <tr><td>5V</td><td>5.053 V</td></tr> <tr><td>3.3V</td><td>3.328 V</td></tr> <tr><td>IO Voltage +1.8V</td><td>1.840 V</td></tr> <tr><td>DDR3 +1.5V</td><td>1.536 V</td></tr> <tr><td>CPU VCore +0.9V</td><td>0.944 V</td></tr> <tr><td>Ethernet +1.2V</td><td>1.216 V</td></tr> <tr><td>DDR3 +0.75V</td><td>0.768 V</td></tr> <tr><td>RTC 3.0V</td><td>3.280 V</td></tr> <tr><td>Flash/Battery Module</td><td>Charged(3.924V)</td></tr> </table> </div>	CPU Temperature	62 °C	Controller Temp.	35 °C	SAS Chip Temp.	65 °C	12V	11.734 V	5V	4.999 V	3.3V	3.296 V	IO Voltage +1.8V	1.824 V	DDR3 +1.5V	1.536 V	CPU VCore +0.9V	0.928 V	Ethernet +1.2V	1.216 V	DDR3 +0.75V	0.752 V	RTC 3.0V	3.248 V	Flash/Battery Module	Charging(3.819V)	Module Power Cycles	206	Module Power On Hours	3702	Module Temperature	45	Module Charge Counts	12	CPU Temperature	54 °C	Controller Temp.	33 °C	SAS Chip Temp.	54 °C	12V	11.856 V	5V	5.053 V	3.3V	3.328 V	IO Voltage +1.8V	1.840 V	DDR3 +1.5V	1.536 V	CPU VCore +0.9V	0.944 V	Ethernet +1.2V	1.216 V	DDR3 +0.75V	0.768 V	RTC 3.0V	3.280 V	Flash/Battery Module	Charged(3.924V)
CPU Temperature	62 °C																																																												
Controller Temp.	35 °C																																																												
SAS Chip Temp.	65 °C																																																												
12V	11.734 V																																																												
5V	4.999 V																																																												
3.3V	3.296 V																																																												
IO Voltage +1.8V	1.824 V																																																												
DDR3 +1.5V	1.536 V																																																												
CPU VCore +0.9V	0.928 V																																																												
Ethernet +1.2V	1.216 V																																																												
DDR3 +0.75V	0.752 V																																																												
RTC 3.0V	3.248 V																																																												
Flash/Battery Module	Charging(3.819V)																																																												
Module Power Cycles	206																																																												
Module Power On Hours	3702																																																												
Module Temperature	45																																																												
Module Charge Counts	12																																																												
CPU Temperature	54 °C																																																												
Controller Temp.	33 °C																																																												
SAS Chip Temp.	54 °C																																																												
12V	11.856 V																																																												
5V	5.053 V																																																												
3.3V	3.328 V																																																												
IO Voltage +1.8V	1.840 V																																																												
DDR3 +1.5V	1.536 V																																																												
CPU VCore +0.9V	0.944 V																																																												
Ethernet +1.2V	1.216 V																																																												
DDR3 +0.75V	0.768 V																																																												
RTC 3.0V	3.280 V																																																												
Flash/Battery Module	Charged(3.924V)																																																												

The following are the information of Flash-based Backup module (FBM):

Hardware information	Description
Flash/Battery Module	The states of Flash-based Backup module
Module Power Cycles	Indicates the count of FBM power on/off cycles
Module Power On Hours	Count of hours in power-on state
Module Temperature	The temperature of FBM
Module Charge Counts	Indicates the count of FBM charge

The Hardware Monitor Information provides the temperature, fan speed (chassis fan) and voltage levels of the RAID subsystem. All items are also unchangeable. When the threshold values are surpassed, warning messages will be indicated through the LCD, LED and alarm buzzer.

Item	Warning Condition
CPU Temperature	> 90 Celsius
Controller Board Temperature	> 80 Celsius
HDD Temperature	> 65 Celsius
Fan Speed	< 700 RPM
Power Supply +12V	< 10.5V or > 13.5V
Power Supply +5V	< 4.7V or > 5.4V
Power Supply +3.3V	< 3.0V or > 3.6V
DDR-II +1.8V	< 1.62V or > 1.98V
CPU +1.8V	< 1.62V or > 1.98V
CPU +1.2V	< 1.08V or > 1.32V
CPU +1.0V	< 0.9V or > 1.1V
DDR-II +0.9V	< 0.81V or > 0.99V
RTC 3.0V	< 2.7V

Chapter 6 System Maintenance

6.1 Upgrading the RAID Controller's Cache Memory

The RAID controller is equipped with one DDR3 SDRAM socket. By default, the RAID controller comes with at least 2GB of memory that is expandable to a maximum of 8GB. The expansion memory module can be purchased from your dealer.

Memory Type: DDR3-1866/1600 ECC SDRAM 240pin

Memory Size: Supports 240pin DDR3 of 1GB, 2GB, 4GB or 8GB.

6.1.1 Installing Memory Module

1. Shutdown the RAID controller using the "Shutdown Controller" function in proRAID Manager GUI.
2. Turn off the switch of the power supplies and unplug all power cords.
3. Loosen the thumbscrews of the controller module then pull out the controller module.
4. Remove the memory module from the RAM socket of the RAID controller by pressing the ejector clips until the memory module pops out of the socket.
5. Align the new memory module into the socket. Make sure the notch is aligned with the key on the socket itself. With the ejector clips in open position, press down the memory module into the socket until it sinks into place. The ejector clips will automatically close to lock the memory module.
6. Reinsert the Controller Module.
7. If the RAID Subsystem has dual (redundant) RAID controllers, repeat Steps 3 to 6 to replace/upgrade the memory of the other Controller Module.
8. Reconnect the SAS cable(s) to the Controller Module(s). Reconnect the power cables and power on the 2 switches of the Power Supply Fan Modules.

6.2 Upgrading the RAID Controller's Firmware

Upgrading Firmware Using Flash Programming Utility

Since the RAID subsystem's controller features flash firmware, it is not necessary to change the hardware flash chip in order to upgrade the controller firmware. User can simply re-program the old firmware through the RS-232 port. New releases of the firmware are available in the form of binary file at vendor's FTP. The file available at the FTP site is usually a self-extracting file that contains the following:

XXXXVVV.BIN Firmware Binary (where "XXXX" refers to the model name and "VVV" refers to the firmware version)

README.TXT It contains the history information of the firmware change. Read this file first before upgrading the firmware.

These files must be extracted from the compressed file and copied to one directory in the host computer.

Establishing the Connection

The firmware can be downloaded to the RAID subsystem's controller using Telnet program with ZMODEM upload protocol, or via web browser-based RAID Manager remote management page.

With Telnet, you must complete the appropriate installation and configuration procedure before proceeding with the firmware upgrade. The Telnet program must support the ZMODEM file transfer protocol.

Web browser-based RAID Manager can be used to update the firmware. A web browser must have been setup before proceeding with the firmware upgrade.

Upgrading Firmware Through Telnet



NOTE: This example uses CRT terminal emulation program. For easier upgrade procedure, it is recommended to use web browser-based firmware upgrade.

1. To connect to RAID subsystem using Telnet, open Terminal Emulation program (example, CRT 6.1) Refer to Section 4.1 for sample step to enable Telnet connection via CRT program.
2. After successful connection, select **Raid System Function** menu. The Password box will be shown. Enter the password (default is 00000000) to login.

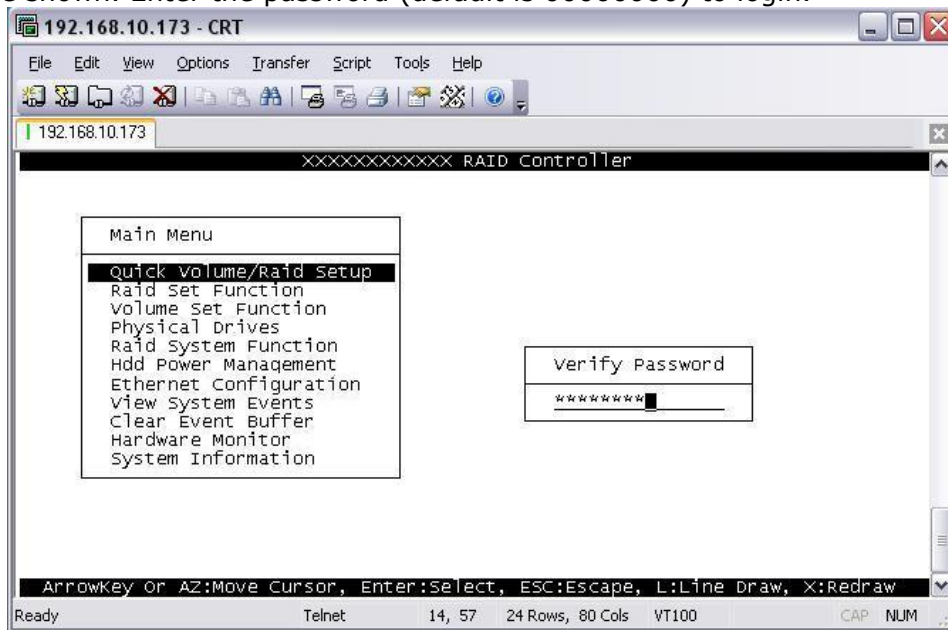

3. After login to Raid System Function menu, select **Update Firmware**. Then choose "Transfer" menu and select "Zmodem Upload List...".

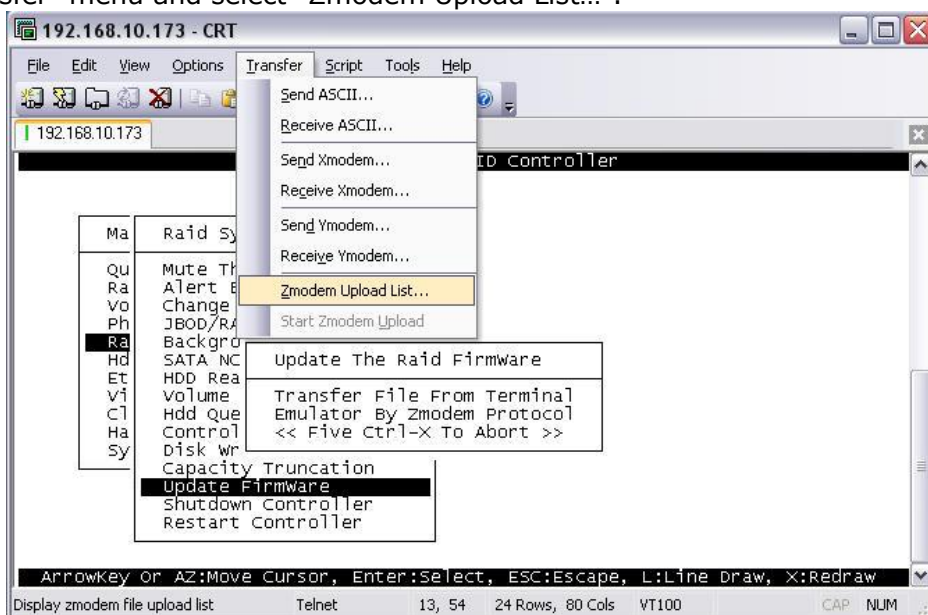

- Select the firmware BINARY file (xxxx-vvv-yyyyyyyyy.bin) and click "Add". Then click "OK".



NOTE: The BOOT firmware file (xxxxBOOT-vvv-yyyyyyyyy.bin) must be upgraded first. Then repeat the steps to upgrade the firmware file (xxxx-vvv-yyyyyyyyy.bin).



- Select **Update Firmware**, and click "Transfer" and then "Start Zmodem Upload".

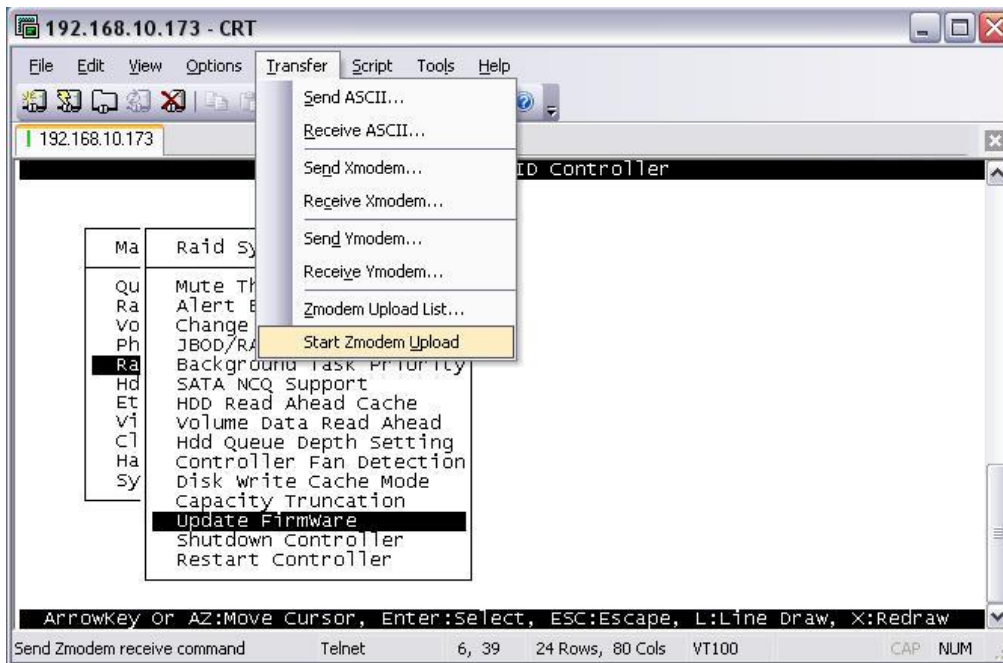

6. A message "Update The Firmware" will be displayed. Select "Yes".

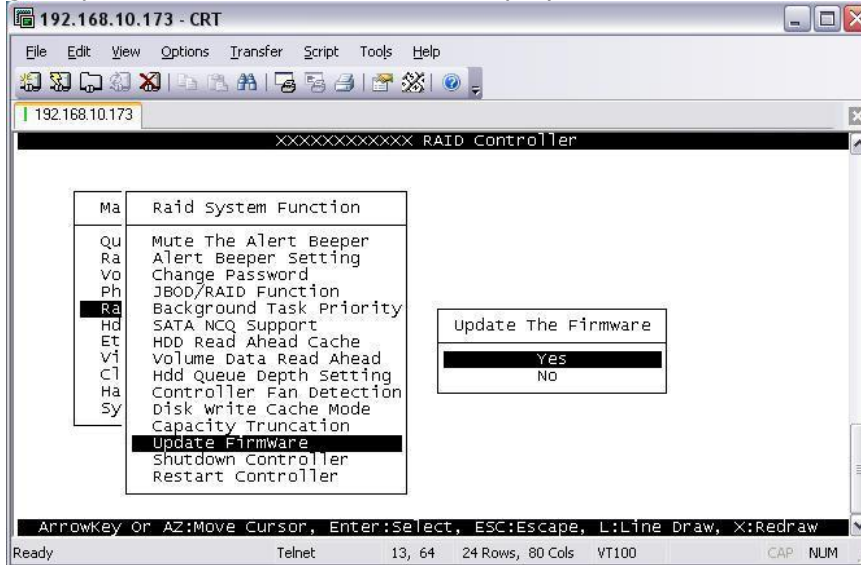

7. Select "Yes" again.

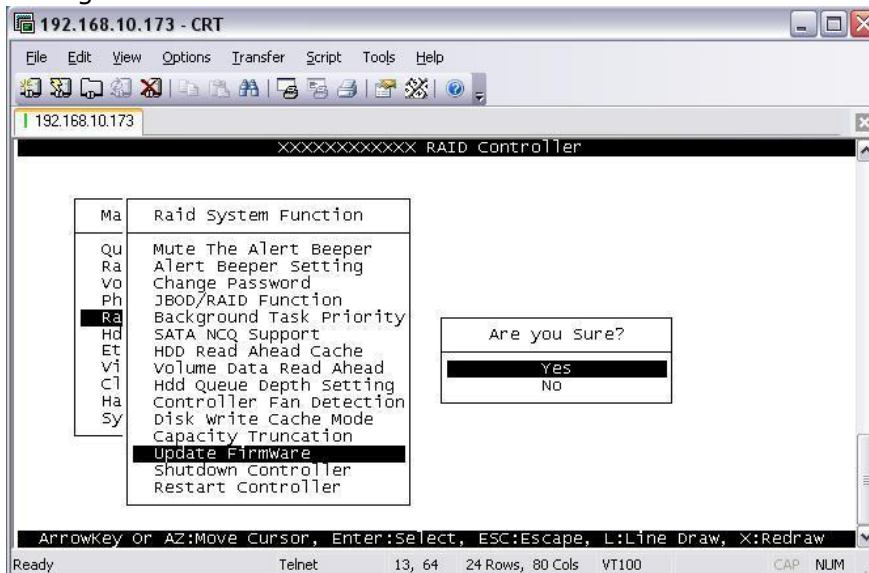

8. Message will show "Start Updating Firmware, Please Wait".

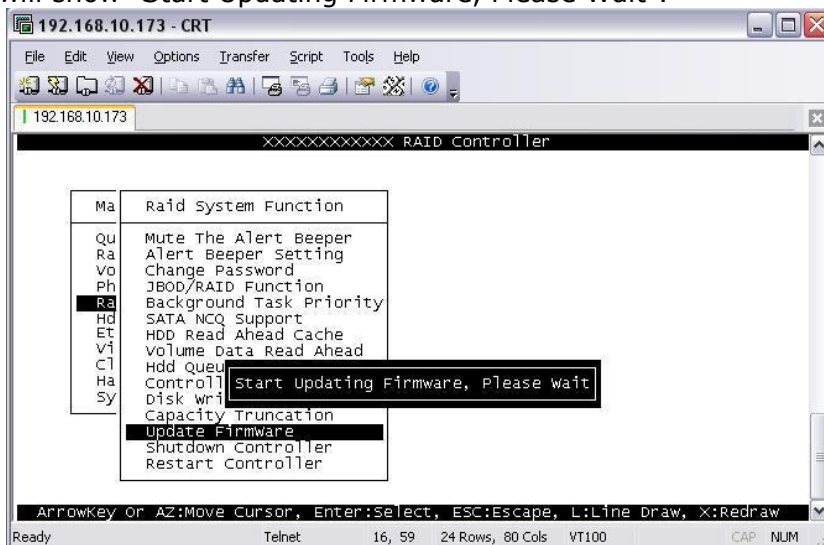

9. Message will show "Firmware has been updated successfully".

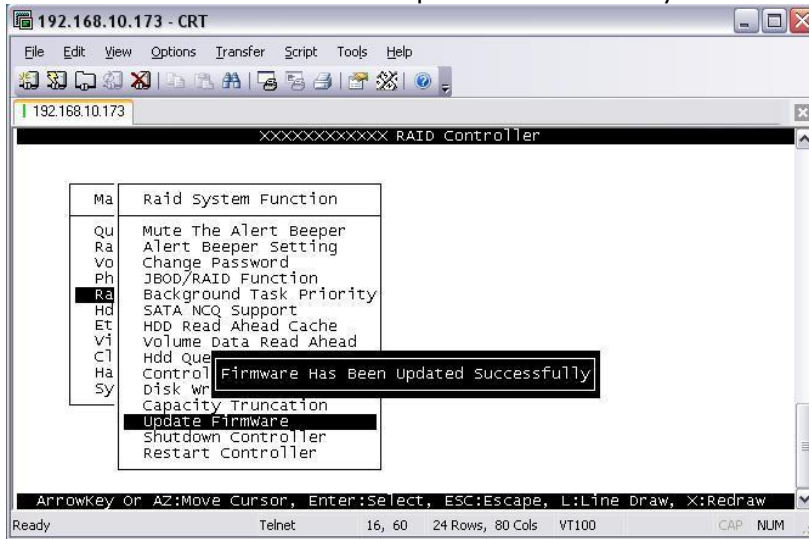

10. The RAID Controller must be restarted in order for the new firmware to take effect.

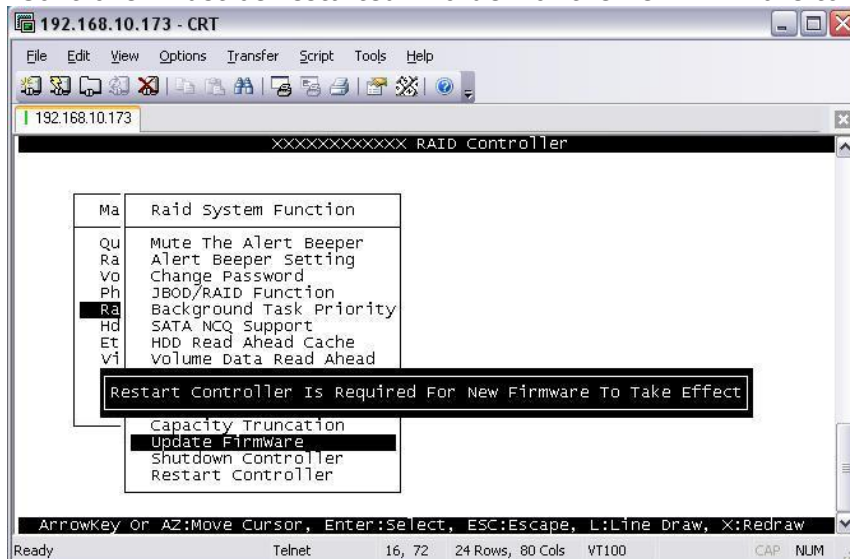

11. Select **Restart Controller** and then select "Yes".

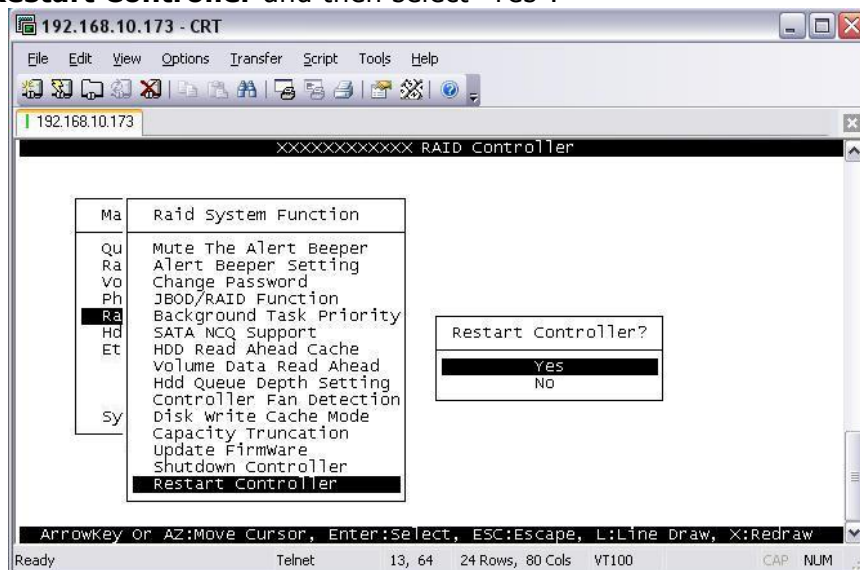

12. Select "Yes" again to confirm. The RAID controller will restart.

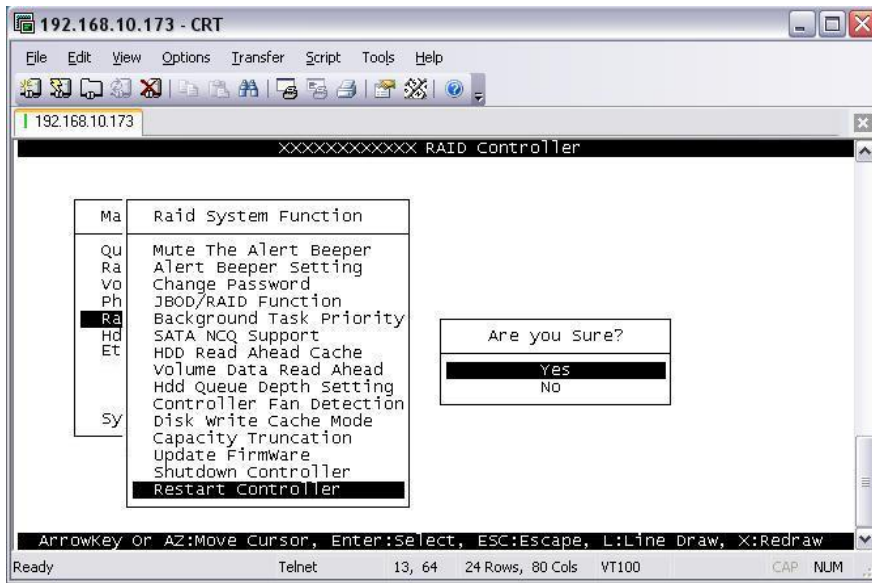

Upgrading Firmware Through Web Browser

Get the new version of firmware for your RAID subsystem controller.



NOTE: When there is new boot ROM firmware that needs to be upgraded, upgrade first the boot ROM firmware. Then repeat the process (steps 1 to 3) to upgrade the firmware code after which a RAID controller restart will be necessary.

1. To upgrade the RAID subsystem firmware, click the **Upgrade Firmware** link under **System Controls** menu. The Upgrade The Raid System Firmware Or Boot Rom screen appears.
2. Click **Browse**. Look in the location where the firmware file was saved. Select the firmware file name "XXXXXXXXX.BIN" and click Open.
3. Select the **Confirm The Operation** option. Click the **Submit** button.

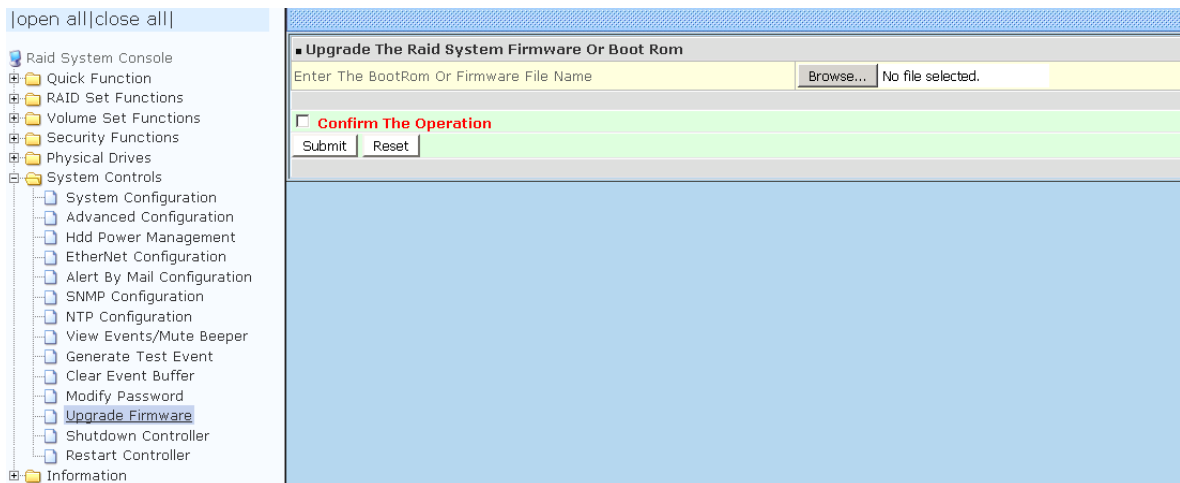

4. The Web Browser begins to download the firmware binary to the controller and start to update the flash ROM.
5. After the firmware upgrade is complete, a message will show "Firmware Has Been Updated Successfully". Restarting the RAID controller is required for the new firmware to take effect.

6.3 Upgrading the Expander Firmware

Upgrading Firmware through Terminal



NOTE: It is important to stop I/O access to RAID subsystem during firmware upgrade.

1. Please use the null modem cable (RJ11 to DB9) and to connect COM2 (CLI) and PC serial port/COM1 Port (or change to other COM Port as necessary).
2. Open Windows HyperTerminal Program. Connect using COM1 (COM Port used in Step1), Baud Rate: 115200, n, 8, 1, Flow Control: None.
3. Press the Enter key and the password prompt will be displayed.
4. Key in the password (Default password: 00000000) to login to CLI.
5. At CLI prompt, input the command to update firmware.

a. CLI> **fdl code**

NOTE:

"fdl code" is the command to update flash firmware code (.fw file).

**"fdl mfgb" is the command to update CFG data code (.dat file)
Make sure you have both files before updating.**

b. CLI> **fdl mfgb**

Please Use XModem Protocol for File Transmission.

Use Q or q to quit Download before starting XModem.

Offset = 0x0

- c. Select Function menu to transfer CFG data .dat file: "Function" → "Transfer" → "Send File" → "Browse" → "Open" and select the .dat file (for example: **8018-mfgdat12gN-20160413.dat**) firmware folder location. Select "Xmodem" Protocol to send firmware file (**Only need about 60 seconds to finish sending firmware file. If not, please repeat steps B and D again**).

Note. If won't to transfer CFG data .dat file, Press Q or q to quit Download before starting data transfer.

d. CLI> **fdl code**

Please Use XModem Protocol for File Transmission.

Use Q or q to quit Download before starting XModem.

Offset = 0x0

- e. Select Function menu to transfer firmware file: "Function" → "Transfer" → "Send File" → "Browse" → "Open" and select the .fw file (for example: **8018-03.01.28.55-20160719.fw**) from firmware folder location. Select "Xmodem" Protocol to send firmware file (**Only need about 60 seconds to finish sending firmware file. If not, please repeat steps D and E again**).

Note. If won't to transfer firmware data .fw file, Press Q or q to quit Download before starting data transfer.

- f. Use GUI or Telnet to Restart controller or power cycle
- g. Re-login to Expander CLI.
- h. Use "sys" command to verify Expander firmware version.
CLI>**sys**

Important: Please do not use the "reset" command on this step.

6.4 Replacing Subsystem Components

6.4.1 Replacing Controller Module

1. Make sure the subsystem is in power off state. Loosen the thumbscrews on the sides of the Controller Module case.
2. Use the Controller handle to pull out the defective Controller.
3. Insert and slide the new Controller in. Note that it may be necessary to remove the old/defective Controller Module from the case and install the new one.
4. Tighten the thumbscrews on the sides of the Controller Module case.

6.4.1.1 Replacing Controller Module with Controller Blanking Plate

When replacing a failed Controller Module with Blanking Plate, please follow these steps:

1. Loosen thumbscrews of the failed Controller Module.
2. Use the Controller Module handle to remove the failed Controller Module from the subsystem.
3. Insert the Controller Blanking Plate.
4. Tighten the screws of the Controller Blanking Plate.



When replacing a failed component online, it is not recommended to remove the failed component for a long period of time; proper air flow within the enclosure might fail causing high controller/disk drive temperature

6.4.2 Replacing Power Supply Fan Module

When replacing a failed power supply fan module (PSFM), please follow these steps:

1. Turn off the Power On/Off Switch of the failed PSFM.
2. Disconnect the power cord from the AC Inlet Plug of PSFM.
3. Loosen thumbscrews of the PSFM.
4. Use the handle to pull out the defective PSFM.
5. Before inserting the new PSFM, make sure the Power On/Off Switch is on "Off" state.
6. Insert and slide the new PSFM in until it clicks into place.



IMPORTANT: When the subsystem is online and a Power Supply fails, and the replacement Power Supply module is not yet available, the failed Power Supply Module can be replaced with the Plate Cover. This is to maintain proper airflow within the enclosure. (Refer to next section)

When replacing a failed component online, it is not recommended to remove the failed component for a long period of time; proper air flow within the enclosure might fail causing high controller/disk drive temperature.

7. Connect the power cord to the AC Inlet Plug of PSFM.
8. Tighten the thumbscrews of the PSFM.
9. Turn on the Power On/Off Switch of the PSFM.



NOTE: After replacing the Power Supply Fan Module and turning on the Power On/Off Switch of the PSFM, the Power Supply will not power on immediately. The Fan in the PSFM will spin-up until the RPM becomes stable. When Fan RPM is already stable, the RAID controller will then power on the Power Supply. This process takes more or less 30 seconds. This safety measure helps prevent possible Power Supply overheating when the Fan cannot work.

6.4.2.1 Replacing Power Supply Fan Module with Plate Cover

When replacing a failed power supply fan module (PSFM) with Plate Cover, please follow these steps:

1. Turn off the Power On/Off Switch of the failed PSFM.
2. Disconnect the power cord from the AC Inlet Plug of PSFM.
3. Loosen thumbscrews of the failed PSFM.
4. Pull out the defective PSFM.
5. Insert the PSFM Plate Cover carefully.