

# **iSCSI GbE to SAS/SATA II RAID Subsystem**

## **User Manual**

Revision 1.0

# Table of Contents

<b>Preface .....</b>	<b>6</b>
<b>Before You Begin .....</b>	<b>7</b>
Safety Guidelines .....	7
Controller Configurations .....	7
Packaging, Shipment and Delivery .....	7
<b>Chapter 1 Introduction.....</b>	<b>9</b>
1.1 Technical Specifications.....	11
1.2 Terminology .....	13
1.3 RAID Levels.....	15
1.4 Volume Relationship Diagram.....	16
<b>Chapter 2 Identifying Parts of the RAID Subsystem.....</b>	<b>17</b>
2.1 Main Components.....	17
2.1.2 Front View.....	17
2.1.2.1 Disk Trays .....	18
2.1.2.2 LCD Front Panel.....	19
2.1.2 Rear View .....	21
2.2 Controller Module .....	22
2.2.1 Controller Module Panel.....	23
2.3 Power Supply / Fan Module (PSFM).....	24
2.3.1 PSFM Panel.....	25
2.4 Checklist before Starting .....	26
<b>Chapter 3 Getting Started with the Subsystem.....</b>	<b>28</b>
3.1 Connecting the iSCSI RAID Subsystem to the Network.....	28
3.2 Powering On .....	28
3.3 Disk Drive Installation .....	29
3.3.1 Installing a SAS Disk Drive in a Disk Tray .....	29
3.3.2 Installing a SATA Disk Drive (Dual Controller Mode) in a Disk Tray .....	32
3.4 iSCSI Introduction .....	35
<b>Chapter 4 Quick Setup .....</b>	<b>37</b>

4.1	Management Interfaces.....	37
4.1.1	Serial Console Port.....	37
4.1.2	Remote Control – Secure Shell.....	37
4.1.3	LCD Control Module (LCM).....	38
4.1.4	Web GUI.....	40
4.2	How to Use the System Quickly.....	42
4.2.1	Quick Installation.....	42
4.2.2	Volume Creation Wizard.....	45
<b>Chapter 5 Configuration.....</b>		<b>48</b>
5.1	Web GUI Management Interface Hierarchy.....	48
5.2	System Configuration.....	50
5.2.1	System Setting.....	50
5.2.2	Network Setting.....	51
5.2.3	Login Setting.....	52
5.2.4	Mail Setting.....	53
5.2.5	Notification Setting.....	54
5.3	iSCSI Configuration.....	55
5.3.1	NIC.....	56
5.3.2	Entity Property.....	59
5.3.3	Node.....	60
5.3.4	Session.....	63
5.3.5	CHAP Account.....	64
5.4	Volume Configuration.....	65
5.4.1	Physical Disk.....	65
5.4.2	RAID Group.....	68
5.4.3	Virtual Disk.....	71
5.4.4	Snapshot.....	76
5.4.5	Logical Unit.....	79
5.4.6	Example.....	80
5.5	Enclosure Management.....	85
5.5.1	Hardware Monitor.....	85
5.5.2	UPS.....	87
5.5.3	SES.....	89

5.5.4	Hard Drive S.M.A.R.T. Support.....	89
5.6	System Maintenance .....	91
5.6.1	System Information.....	91
5.6.2	Event Log.....	92
5.6.3	Upgrade .....	93
5.6.4	Firmware Synchronization .....	94
5.6.5	Reset to Factory Default .....	94
5.6.6	Import and Export .....	95
5.6.7	Reboot and Shutdown.....	95
5.7	Home/Logout/Mute.....	96
5.7.1	Home .....	96
5.7.2	Logout .....	96
5.7.3	Mute .....	96
<b>Chapter 6</b>	<b>Advanced Operations.....</b>	<b>97</b>
6.1	Volume Rebuild .....	97
6.2	RG Migration.....	99
6.3	VD Extension.....	101
6.4	Snapshot / Rollback.....	102
6.4.1	Create Snapshot Volume.....	103
6.4.2	Auto Snapshot.....	104
6.4.3	Rollback.....	105
6.5	Disk Roaming.....	106
6.6	VD Clone .....	107
6.7	SAS JBOD Expansion .....	113
6.7.1	Connecting JBOD .....	113
6.8	MPIO and MC/S .....	117
6.9	Trunking and LACP.....	119
6.10	Dual Controllers .....	121
6.10.1	Perform I/O.....	121
6.10.2	Ownership.....	122
6.10.3	Controller Status.....	122
6.11	QReplica (Optional) .....	124

<b>Chapter 7 Troubleshooting .....</b>	<b>134</b>
7.1 System Buzzer .....	134
7.2 Event Notifications .....	134
<b>Appendix .....</b>	<b>142</b>
A. Certification list .....	142
B. Microsoft iSCSI initiator .....	146

## Preface

### About this manual

This manual provides information regarding the quick installation and hardware features of the **RAID subsystem**. This document also describes how to use the storage management software. Information contained in the manual has been reviewed for accuracy, but not for product warranty because of the various environment/OS/settings. Information and specifications will be changed without further notice.

This manual uses section numbering for every topics being discussed for easy and convenient way of finding information in accordance with the user's needs. The following icons are being used for some details and information to be considered in going through with this manual:

**NOTES:**

These are notes that contain useful information and tips that the user must give attention to in going through with the subsystem operation.

**IMPORTANT!**

These are the important information that the user must remember.

**WARNING!**

These are the warnings that the user must follow to avoid unnecessary errors and bodily injury during hardware and software operation of the subsystem.

**CAUTION:**

These are the cautions that user must be aware to prevent damage to the equipment and its components.

### Copyright

No part of this publication may be reproduced, stored in a retrieval system, or transmitted in any form or by any means, electronic, mechanical, photocopying, recording or otherwise, without the prior written consent.

### Trademarks

All products and trade names used in this document are trademarks or registered trademarks of their respective holders.

### Changes

The material in this document is for information only and is subject to change without notice.

## Before You Begin

Before going through with this manual, you should read and focus to the following safety guidelines. Notes about the subsystem's controller configuration and the product packaging and delivery are also included.

### Safety Guidelines

To provide reasonable protection against any harm on the part of the user and to obtain maximum performance, user is advised to be aware of the following safety guidelines particularly in handling hardware components:

#### *Upon receiving of the product:*

- ❖ Place the product in its proper location.
- ❖ To avoid unnecessary dropping out, make sure that somebody is around for immediate assistance.
- ❖ It should be handled with care to avoid dropping that may cause damage to the product. Always use the correct lifting procedures.

#### *Upon installing of the product:*

- ❖ Ambient temperature is very important for the installation site. It must not exceed 30°C. Due to seasonal climate changes; regulate the installation site temperature making it not to exceed the allowed ambient temperature.
- ❖ Before plugging-in any power cords, cables and connectors, make sure that the power switches are turned off. Disconnect first any power connection if the power supply module is being removed from the enclosure.
- ❖ Outlets must be accessible to the equipment.
- ❖ All external connections should be made using shielded cables and as much as possible should not be performed by bare hand. Using anti-static hand gloves is recommended.
- ❖ In installing each component, secure all the mounting screws and locks. Make sure that all screws are fully tightened. Follow correctly all the listed procedures in this manual for reliable performance.





### Controller Configurations

This RAID subsystem supports single and dual controller configuration.

### Packaging, Shipment and Delivery

- ❖ Before removing the subsystem from the shipping carton, you should visually inspect the physical condition of the shipping carton.
- ❖ Unpack the subsystem and verify that the contents of the shipping carton are all there and in good condition.
- ❖ Exterior damage to the shipping carton may indicate that the contents of the carton are damaged.
- ❖ If any damage is found, do not remove the components; contact the dealer where you purchased the subsystem for further instructions.

The shipping package contains the following:

	<p>iSCSI RAID Subsystem Unit</p>
	<p>Two (2) power cords</p>
	<p>One (1) Ethernet LAN cable for single controller                  Note: Two (2) Ethernet LAN cables for dual controller</p>
	<p>One (1) LC-LC Fibre Optical Cable for single controller                  Note: Two(2) LC-LC Fibre Optical Cables for dual controller</p>
	<p>One (1) External null modem cable                  Note: Two (2) External null modem cables for dual controller</p>
	<p>User Manual</p>

**NOTE: If any damage is found, contact the dealer or vendor for assistance.**



## Chapter 1 Introduction



### The iSCSI RAID Subsystem

#### Unparalleled Performance & Reliability

- Supports Dual-active controllers
- Front-end 2/4 x 10Gb iSCSI
- Supports 802.3ad port trunking, Link Aggregation Control Protocol (LACP)
- High data bandwidth of system architecture by powerful 64-bit RAID processor

#### Unsurpassed Data Availability

- The RAID 6 capability provides the highest level of data protection
- Supports snapshot-on-the-box w/o relying on host software
- Supports Microsoft Windows Volume Shadow Copy Services (VSS)

#### Exceptional Manageability Menu-driven front panel display

- Management GUI via serial console, SSH telnet, Web and secure web (HTTPS)
- Event notification via Email and SNMP trap
- Menu-driven front panel display

## Features

- Front-end 2/4 x 10Gb ports support independent access, fail-over and load-balancing (802.3ad port trunking, LACP)
- Supports iSCSI jumbo frame
- Supports Microsoft Multipath I/O (MPIO)
- Supports RAID levels 0, 1, 0+1, 3, 5, 6, 10, 30, 50, 60 and JBOD
- Local N-way mirror: Extension to RAID 1 level, N copies of the disk
- Global and dedicated hot spare disks
- Write-through or write-back cache policy for different application usage
- Supports greater than 2TB per volume set (64-bit LBA support)
- Supports manual or scheduling volume snapshot (up to 32 snapshots)
- Snapshot rollback mechanism
- On-line volume migration with no system down-time
- Online volume expansion
- Instant RAID volume availability and background initialization
- Supports S.M.A.R.T, NCQ and OOB Staggered Spin-up capable drives

## 1.1 Technical Specifications

<b>Model</b>	<b>EP-2124S1/D1-GAS3</b>
<b>RAID Controller</b>	iSCSI-SAS
<b>Controller</b>	Single/Dual (Redundant)
<b>Host Interface</b>	Two/Four 10Gb/s Ethernet
<b>Disk Interface</b>	SAS 3Gb or SATA II
<b>SAS expansion</b>	4x mini SAS (3Gb/s)
<b>Processor Type</b>	Intel IOP342 64-bit (Chevelon dual core)
<b>Cache Memory</b>	2GB~4GB /4GB~8GB DDR-II ECC SDRAM
<b>Battery Backup</b>	Optional Hot Pluggable BBM
<b>Management Port support</b>	Yes
<b>Monitor Port support</b>	Yes
<b>UPS connection</b>	Yes
<b>RAID level</b>	0, 1, 0+1, 3, 5, 6, 10, 30, 50, 60 and JBOD
<b>Logical volume</b>	Up to 1024
<b>iSCSI Jumbo frame support</b>	Yes
<b>Supports Microsoft Multipath I/O (MPIO)</b>	Yes
<b>802.3ad Port Trunking, LACP Support</b>	Yes
<b>Host connection</b>	Up to 32
<b>Host clustering</b>	Up to 16 for one logical volume
<b>Manual/scheduling volume snapshot</b>	Up to 32
<b>Hot spare disks</b>	Global and dedicated
<b>Host access control</b>	Read-Write & Read-Only
<b>Online Volume migration</b>	Yes
<b>Online Volume sets expansion</b>	Yes
<b>Configurable stripe size</b>	Yes
<b>Auto volume rebuild</b>	Yes
<b>N-way mirror (N copies of the disk)</b>	Yes
<b>Microsoft Windows Volume Shadow Copy Services (VSS)</b>	Yes
<b>Supports CHAP authentication</b>	Yes

<b>S.M.A.R.T. support</b>	Yes
<b>Snapshot rollback mechanism support</b>	Yes
<b>Platform</b>	Rackmount
<b>Form Factor</b>	2U
<b># of Hot Swap Trays</b>	12
<b>Tray Lock</b>	Yes
<b>Disk Status Indicator</b>	Access / Fail LED
<b>Backplane</b>	SAS2 / SATA3 Single BP
<b># of PS/Fan Modules</b>	460W x 2 w/PFC
<b># of Fans</b>	2
<b>Power requirements</b>	AC 90V ~ 264V Full Range, 10A ~ 5A, 47Hz ~ 63Hz
<b>Relative Humidity</b>	10% ~ 85% Non-condensing
<b>Operating Temperature</b>	10°C ~ 40°C (50°F ~ 104°F)
<b>Physical Dimension</b>	555(L) x 482(W) x 88(H) mm
<b>Weight (Without Disk)</b>	14.5/16 Kg

*Specification is subject to change without notice.*

## 1.2 Terminology

The document uses the following terms:

<b>RAID</b>	<b>Redundant Array of Independent Disks.</b> There are different RAID levels with different degree of data protection, data availability, and performance to host environment.
<b>PD</b>	The <b>Physical Disk</b> belongs to the member disk of one specific RAID group.
<b>RG</b>	<b>Raid Group.</b> A collection of removable media. One RG consists of a set of VDs and owns one RAID level attribute.
<b>VD</b>	<b>Virtual Disk.</b> Each RD could be divided into several VDs. The VDs from one RG have the same RAID level, but may have different volume capacity.
<b>LUN</b>	<b>Logical Unit Number.</b> A logical unit number (LUN) is a unique identifier which enables it to differentiate among separate devices (each one is a logical unit).
<b>GUI</b>	<b>Graphic User Interface.</b>
<b>RAID cell</b>	When creating a RAID group with a compound RAID level, such as 10, 30, 50 and 60, this field indicates the number of subgroups in the RAID group. For example, 8 disks can be grouped into a RAID group of RAID 10 with 2 cells, 4 cells. In the 2-cell case, PD {0, 1, 2, 3} forms one RAID 1 subgroup and PD {4, 5, 6, 7} forms another RAID 1 subgroup. In the 4-cells, the 4 subgroups are PD {0, 1}, PD {2, 3}, PD {4, 5} and PD {6,7}.
<b>WT</b>	<b>Write-Through</b> cache-write policy. A caching technique in which the completion of a write request is not signaled until data is safely stored in non-volatile media. Each data is synchronized in both data cache and accessed physical disks.
<b>WB</b>	<b>Write-Back</b> cache-write policy. A caching technique in which the completion of a write request is signaled as soon as the data is in cache and actual writing to non-volatile media occurs at a later time. It speeds up system write performance but needs to bear the risk where data may be inconsistent between data cache and the physical disks in one short time interval.
<b>RO</b>	Set the volume to be <b>Read-Only</b> .
<b>DS</b>	<b>Dedicated Spare</b> disks. The spare disks are only used by one specific RG. Others could not use these dedicated spare disks for any rebuilding purpose.
<b>GS</b>	<b>Global Spare</b> disks. GS is shared for rebuilding purpose. If some RGs need to use the global spare disks for rebuilding, they could get the spare disks out from the common spare disks pool for such requirement.

<b>DG</b>	<b>DeGraded</b> mode. Not all of the array's member disks are functioning, but the array is able to respond to application read and write requests to its virtual disks.
<b>SCSI</b>	<b>S</b> mall <b>C</b> omputer <b>S</b> ystems <b>I</b> nterface.
<b>SAS</b>	<b>S</b> erial <b>A</b> ttached <b>S</b> CSI.
<b>S.M.A.R.T.</b>	<b>S</b> elf- <b>M</b> onitoring <b>A</b> nalysis and <b>R</b> eporting <b>T</b> echnology.
<b>WWN</b>	<b>W</b> orld <b>W</b> ide <b>N</b> ame.
<b>HBA</b>	<b>H</b> ost <b>B</b> us <b>A</b> dapter.
<b>SES</b>	<b>S</b> CSI <b>E</b> nclosure <b>S</b> ervices.
<b>NIC</b>	<b>N</b> etwork <b>I</b> nterface <b>C</b> ard.
<b>BBM</b>	<b>B</b> attery <b>B</b> ackup <b>M</b> odule
<b>iSCSI</b>	<b>I</b> nternet <b>S</b> mall <b>C</b> omputer <b>S</b> ystems <b>I</b> nterface.
<b>LACP</b>	<b>L</b> ink <b>A</b> ggregation <b>C</b> ontrol <b>P</b> rotocol.
<b>MPIO</b>	<b>M</b> ulti- <b>P</b> ath <b>I</b> nput/ <b>O</b> utput.
<b>MC/S</b>	<b>M</b> ultiple <b>C</b> onnections per <b>S</b> ession
<b>MTU</b>	<b>M</b> aximum <b>T</b> ransmission <b>U</b> nit.
<b>CHAP</b>	<b>C</b> hallenge <b>H</b> andshake <b>A</b> uthentication <b>P</b> rotocol. An optional security mechanism to control access to an iSCSI storage system over the iSCSI data ports.
<b>iSNS</b>	<b>I</b> nternet <b>S</b> torage <b>N</b> ame <b>S</b> ervice.
<b>SBB</b>	<b>S</b> torage <b>B</b> ridge <b>B</b> ay. The objective of the Storage Bridge Bay Working Group (SBB) is to create a specification that defines mechanical, electrical and low-level enclosure management requirements for an enclosure controller slot that will support a variety of storage controllers from a variety of independent hardware vendors ("IHVs") and system vendors.
<b>Dongle</b>	Dongle board is for SATA II disk connection to the backplane.

### 1.3 RAID Levels

The subsystem can implement several different levels of RAID technology. RAID levels supported by the subsystem are shown below.

RAID Level	Description	Min. Drives
0	Block striping is provide, which yields higher performance than with individual drives. There is no redundancy.	1
1	Drives are paired and mirrored. All data is 100% duplicated on an equivalent drive. Fully redundant.	2
N-way mirror	Extension to RAID 1 level. It has N copies of the disk.	N
3	Data is striped across several physical drives. Parity protection is used for data redundancy.	3
5	Data is striped across several physical drives. Parity protection is used for data redundancy.	3
6	Data is striped across several physical drives. Parity protection is used for data redundancy. Requires N+2 drives to implement because of two-dimensional parity scheme	4
0 + 1	Mirroring of the two RAID 0 disk arrays. This level provides striping and redundancy through mirroring.	4
10	Striping over the two RAID 1 disk arrays. This level provides mirroring and redundancy through striping.	4
30	Combination of RAID levels 0 and 3. This level is best implemented on two RAID 3 disk arrays with data striped across both disk arrays.	6
50	RAID 50 provides the features of both RAID 0 and RAID 5. RAID 50 includes both parity and disk striping across multiple drives. RAID 50 is best implemented on two RAID 5 disk arrays with data striped across both disk arrays.	6
60	RAID 60 provides the features of both RAID 0 and RAID 6. RAID 60 includes both parity and disk striping across multiple drives. RAID 60 is best implemented on two RAID 6 disk arrays with data striped across both disk arrays.	8
JBOD	The abbreviation of "Just a Bunch Of Disks". JBOD needs at least one hard drive.	1

## 1.4 Volume Relationship Diagram

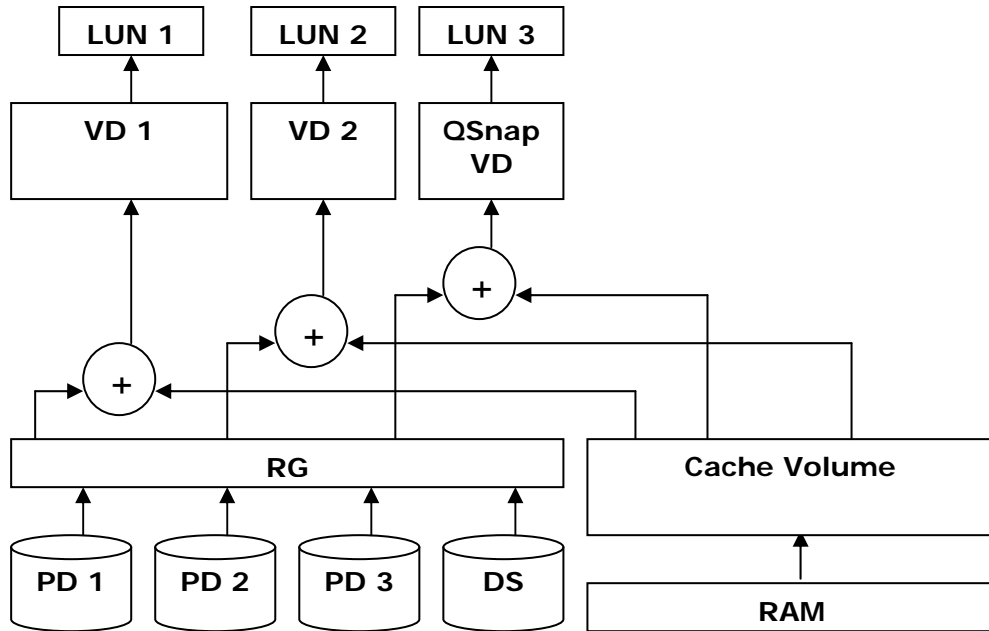

This is the design of volume structure of the iSCSI RAID subsystem. It describes the relationship of RAID components. One RG (RAID group) consists of a set of VDs (Virtual Disk) and owns one RAID level attribute. Each RG can be divided into several VDs. The VDs in one RG share the same RAID level, but may have different volume capacity. All VDs share the CV (Cache Volume) to execute the data transaction. LUN (Logical Unit Number) is a unique identifier, in which users can access through SCSI commands.



## Chapter 2 Identifying Parts of the RAID Subsystem

The illustrations below identify the various parts of the subsystem.

### 2.1 Main Components

#### 2.1.2 Front View



### 2.1.2.1 Disk Trays



#### HDD Status Indicator

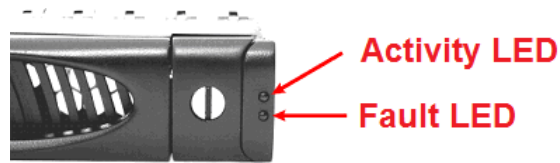

Part	Function
HDD Activity LED	This LED will blink blue when the hard drive is being accessed.
HDD Fault LED	Green LED indicates power is on and hard drive status is good for this slot. If hard drive is defective or failed, the LED is Red. LED is off when there is no hard drive.

#### Lock Indicator

Every Disk Tray is lockable and is fitted with a lock indicator to indicate whether or not the tray is locked into the chassis or not. Each tray is also fitted with an ergonomic handle for easy tray removal.

When the Lock Groove is horizontal, this indicates that the Disk Tray is locked. When the Lock Groove is vertical, then the Disk Tray is unlocked.

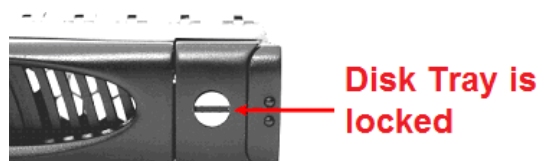
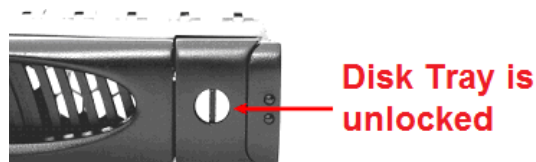



### 2.1.2.2 LCD Front Panel







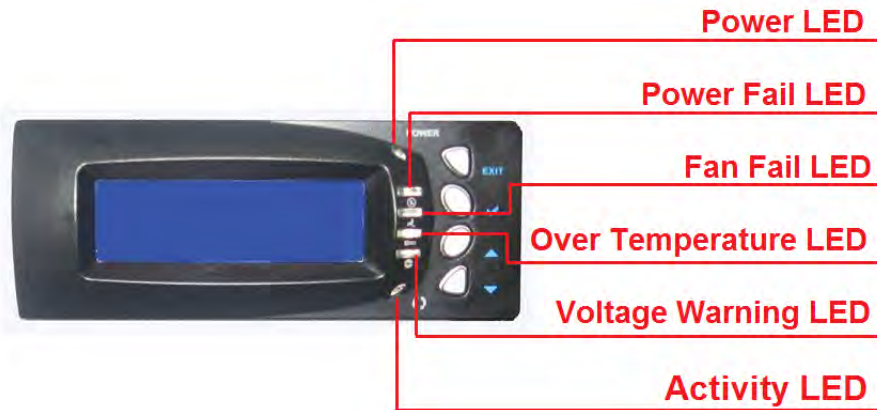

#### Smart Function Front Panel

The smart LCD panel is an option to configure the RAID subsystem. If you are configuring the subsystem using the LCD panel, press the Select button to login and configure the RAID subsystem.

Parts	Function
<b>Up and Down Arrow buttons</b> 	Use the Up or Down arrow keys to go through the information on the LCD screen. This is also used to move between each menu when you configure the subsystem.
<b>Select button</b> 	This is used to enter the option you have selected.
<b>Exit button</b> <b>EXIT</b>	Press this button to return to the previous menu.

## Environment Status LEDs



Parts	Function
<b>Power LED</b>	Green LED indicates power is ON.
<b>Power Fail LED</b> 	If a redundant power supply unit fails, this LED will turn to RED and alarm will sound.
<b>Fan Fail LED</b> 	When a fan fails or the fan's rotational speed is below 1500RPM, this LED will turn red and an alarm will sound.
<b>Over Temperature LED</b> 	If temperature irregularities in the system occurs (HDD slot temperature over 65°C, Controller temperature over 70°C), this LED will turn RED and alarm will sound.
<b>Voltage Warning LED</b> 	An alarm will sound warning of a voltage abnormality and this LED will turn red.
<b>Activity LED</b> 	This LED will blink blue when the RAID subsystem is busy or active.

## 2.1.2 Rear View

### Single Controller

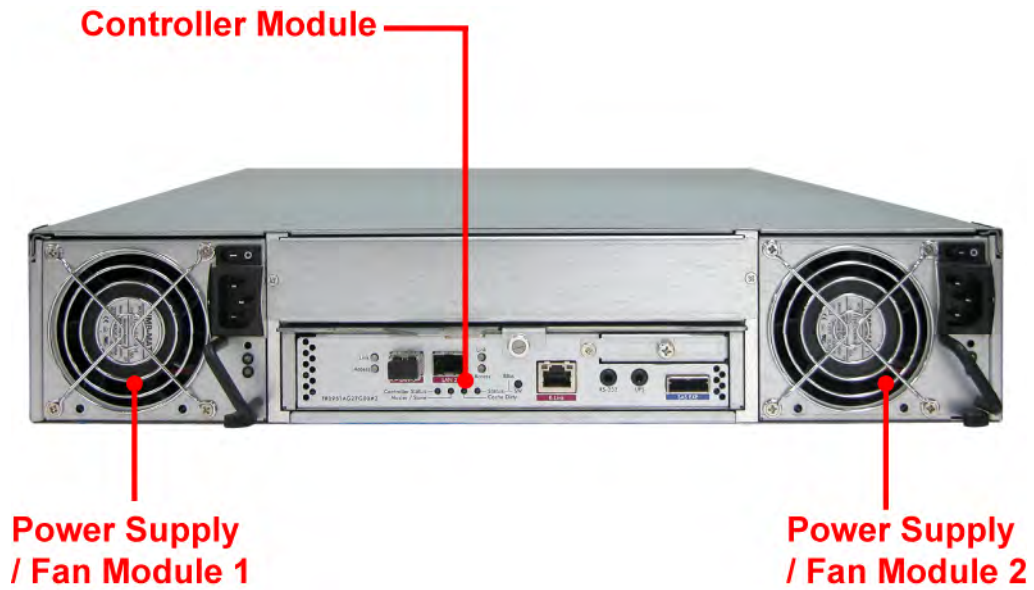

### Dual Controller

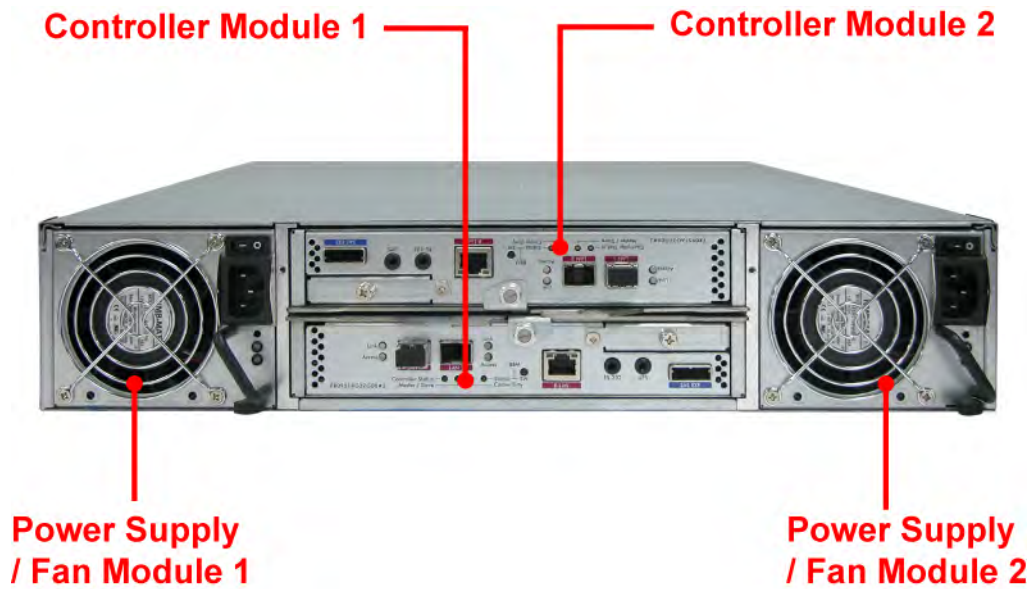

## 1. Controller Module

The subsystem has one or two controller modules.

## 2. Power Supply Unit 1 ~ 2

Two power supplies (power supply 1 and power supply 2) are located at the rear of the subsystem. Each PSFM has one Power Supply and one Fan. The PSFM 1 has Power#1, Fan#1. The PSFM 2 has Power#2, Fan#2.

Turn on the power of these power supplies to power-on the subsystem. The "power" LED at the front panel will turn green.

If a power supply fails to function or a power supply was not turned on, the "⊗" Power fail LED will turn red and an alarm will sound.

## 2.2 Controller Module



**RAID Controller Module**

## 2.2.1 Controller Module Panel

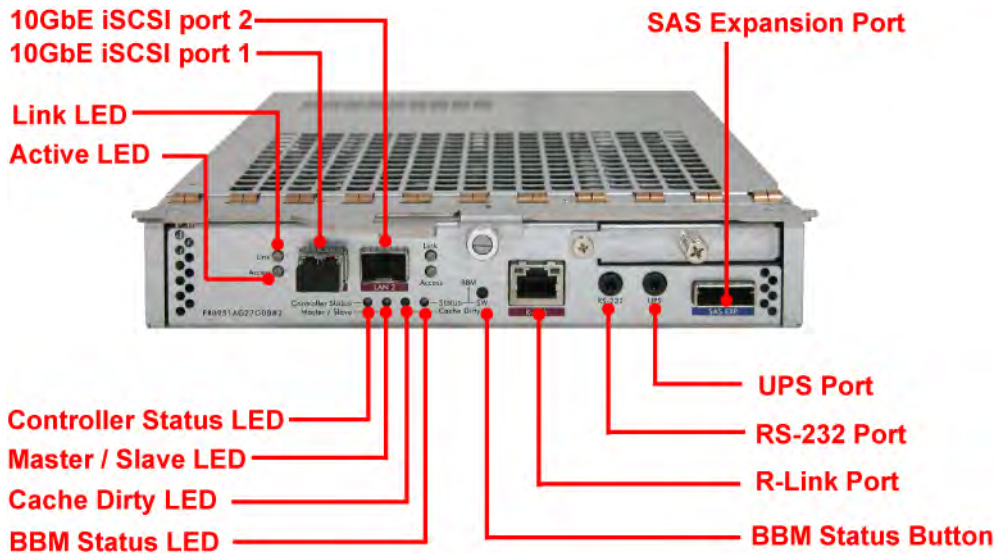

**Note:** Only data port LAN1 is available in default system configuration. Data port LAN2 is optional. It can be purchased separately for upgrade.

### 1. Uninterrupted Power Supply (UPS) Port (APC Smart UPS only)

The subsystem may come with an optional UPS port allowing you to connect an APC Smart UPS device. Connect the cable from the UPS device to the UPS port located at the rear of the subsystem. This will automatically allow the subsystem to use the functions and features of the UPS.

### 2. R-Link Port: Remote Link through RJ-45 Ethernet for remote management

The subsystem is equipped with one 10/100 Ethernet RJ45 LAN port for remote configuration and monitoring. You use web browser to manage the RAID subsystem through Ethernet.

### 3. LAN Ports (Gigabit)

The subsystem is equipped with two LAN data ports (LAN1 and LAN2) for iSCSI connection.

- **Link LED:**

Orange → Asserted when a 1G link is established and maintained.

Blue → Asserted when a 10G link is established and maintained.

- **Access / fail LED:**

Yellow → Asserted when the link is established and packets are being transmitted along with any receive activity.

Red → Asserted when the link can't establish.



#### 4. Controller Health LED

- Green → Controller status normal or in the booting.
- Red → Other than above status.

#### 5. Master/Slave LED

- Green → Master controller.
- Off → Slave controller.

#### 6. Dirty Cache LED

- Orange → Data on the cache waiting for flush to disks.
- Off → No data on the cache.

#### 7. BBM Status LED

- Green → BBM installed and powered
- Off → No BBM

#### 8. BBM Status Button

When the system power is off, press the BBM status button, if the BBM LED is Green, then the BBM still has power to keep data on the cache. If not, then the BBM power is ran out and cannot keep the data on the cache anymore.

## 2.3 Power Supply / Fan Module (PSFM)

The RAID subsystem contains **two 460W Power Supply / Fan Modules**. All the Power Supply / Fan Modules (PSFMs) are inserted into the rear of the chassis.





### 2.3.1 PSFM Panel



The panel of the Power Supply/Fan Module contains: the Power On/Off Switch, the AC Inlet Plug, FAN fail Indicator, and a Power On/Fail Indicator showing the Power Status LED, indicating ready or fail.

Each fan within a PSFM is powered independently of the power supply within the same PSFM. So if the power supply of a PSFM fails, the fan associated with that PSFM will continue to operate and cool the enclosure.

#### FAN Fail Indicator

If fan is failed, this LED will turn to **RED** and alarm will sound.

#### Power On/Fail Indicator

When the power cord connected from main power source is inserted to the AC Power Inlet, the power status LED becomes **RED**. When the switch of the PSFM is turned on, the LED will turn **GREEN**. When the Power On/Fail LED is **GREEN**, the PSFM is functioning normally.



**NOTE:** Each PSFM has one Power Supply and one Fan. The PSFM 1 has Power#1 and Fan#1. The PSFM 2 has Power#2 and Fan#2. When the Power Supply of a PSFM fails, the PSFM need not be removed from the slot if replacement is not yet available. The fan will still work and provide necessary airflow inside the enclosure.



**NOTE:** After replacing the Power Supply Fan Module and turning on the Power On/Off Switch of the PSFM, the Power Supply will not power on immediately. The Fans in the PSFM will spin-up until the RPM becomes stable. When Fan RPM is already stable, the RAID controller will then power on the Power Supply. This process takes more or less 30 seconds. This safety measure helps prevent possible Power Supply overheating when the Fans cannot work.

## 2.4 Checklist before Starting

Before starting, check or prepare the following items.

- ☑ Check **“Certification list”** in Appendix A to confirm the hardware setting is fully supported.
- ☑ Read the latest release note before upgrading. Release note accompanies with its released firmware.
- ☑ A host with a 10GbE NIC or 10GbE iSCSI HBA.
- ☑ CAT 5e, or CAT 6 network cables for management port. FC cable for iSCSI data ports.
- ☑ Prepare storage system configuration plan.
- ☑ Prepare management port and iSCSI data ports network information. When using static IP, please prepare static IP addresses, subnet mask, and default gateway.
- ☑ 10GbE LAN switches (recommended). Or 10GbE LAN switches with VLAN / LACP / Trunking (optional).
- ☑ CHAP security information, including CHAP username and secret (optional).
- ☑ Setup the hardware connection before power on servers. Connect console cable, management port cable, and iSCSI data port cables in advance.
- ☑ In addition, installing an iSNS server is recommended.
- ☑ Power on first, and then power on hosts and iSNS server.
- ☑ Host server is suggested to logon the target twice (both controller 1 and controller 2), and then MPIO should be setup automatically.



**NOTE: iSNS server is recommended for dual controller system.**

For better data service availability, all the connections among host servers, GbE switches, and the dual controllers are recommended as redundant as below.

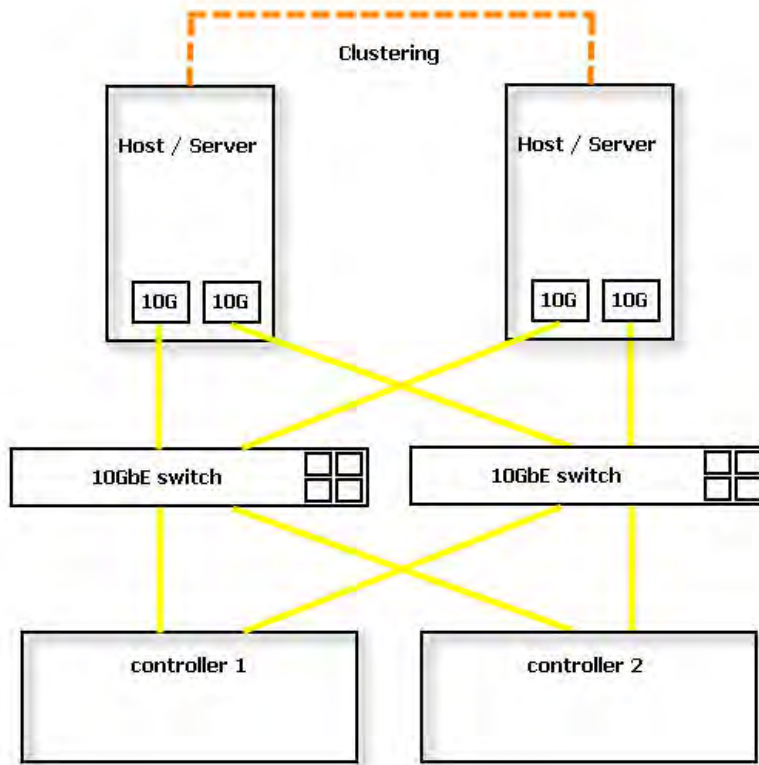

## Chapter 3 Getting Started with the Subsystem

### 3.1 Connecting the iSCSI RAID Subsystem to the Network

To connect the iSCSI unit to the network, insert the network cable that came with the unit into the network port (LAN1) at the back of iSCSI unit. Insert the other end into a Gigabit BASE-T Ethernet connection on your network hub or switch. You may connect the other network ports if needed.

For remote management of iSCSI RAID subsystem, use another network cable to connect the R-Link port to your network.

### 3.2 Powering On

1. Plug in the power cords into the AC Power Input Socket located at the rear of the subsystem.

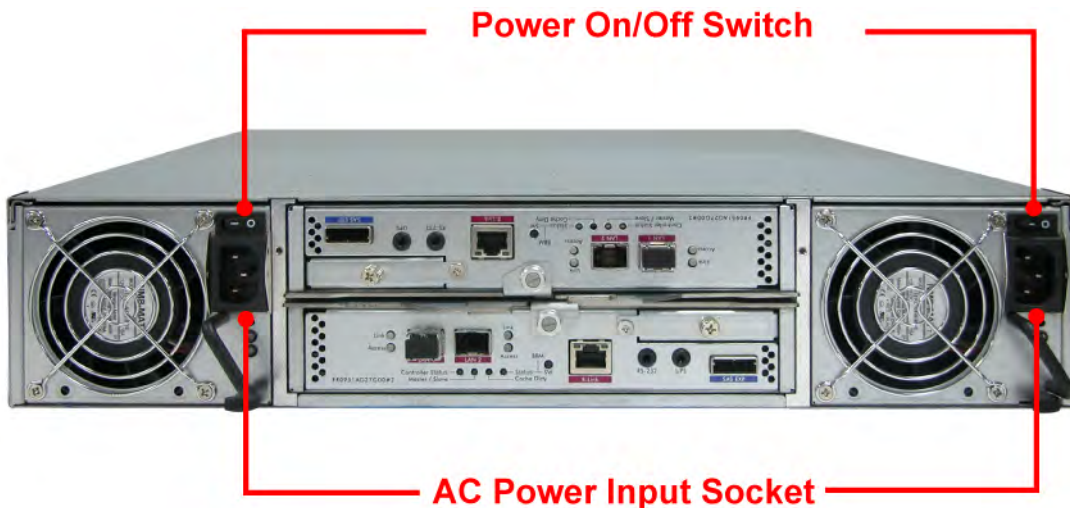

**NOTE:** The subsystem is equipped with redundant, full range power supplies with PFC (power factor correction). The system will automatically select voltage.

2. Turn on each Power On/Off Switch to power on the subsystem.
3. The Power LED on the front Panel will turn green.

### 3.3 Disk Drive Installation

This section describes the physical locations of the hard drives supported by the subsystem and give instructions on installing a hard drive. The subsystem supports hot-swapping allowing you to install or replace a hard drive while the subsystem is running.

#### 3.3.1 Installing a SAS Disk Drive in a Disk Tray

1. Unlock the Disk Trays using a flat-head screw driver by rotating the Lock Groove.

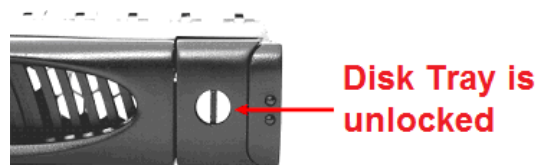

2. Press the Tray Open button and the Disk Tray handle will flip open.



3. Pull out an empty disk tray.



4. Place the hard drive in the disk tray. Turn the disk tray upside down. Align the four screw holes of the SAS disk drive in the four Hole A of the disk tray. To secure the disk drive into the disk tray, tighten four screws on these holes of the disk tray. Note in the picture below where the screws should be placed in the disk tray holes.



**NOTE: All the disk tray holes are labelled accordingly.**

5. Slide the tray into a slot.
6. Press the lever in until you hear the latch click into place. The HDD Fault LED will turn green when the subsystem is powered on and HDD is good.
7. If necessary, lock the Disk Tray by turning the Lock Groove.



### 3.3.2 Installing a SATA Disk Drive (Dual Controller Mode) in a Disk Tray

1. Remove an empty disk tray from the subsystem.



2. Prepare the dongle board and two screws.



3. Place the dongle board in the disk tray. Turn the tray upside down. Align the two screw holes of the dongle board in the two Hole D of the disk tray. Tighten two screws to secure the dongle board into the disk tray.





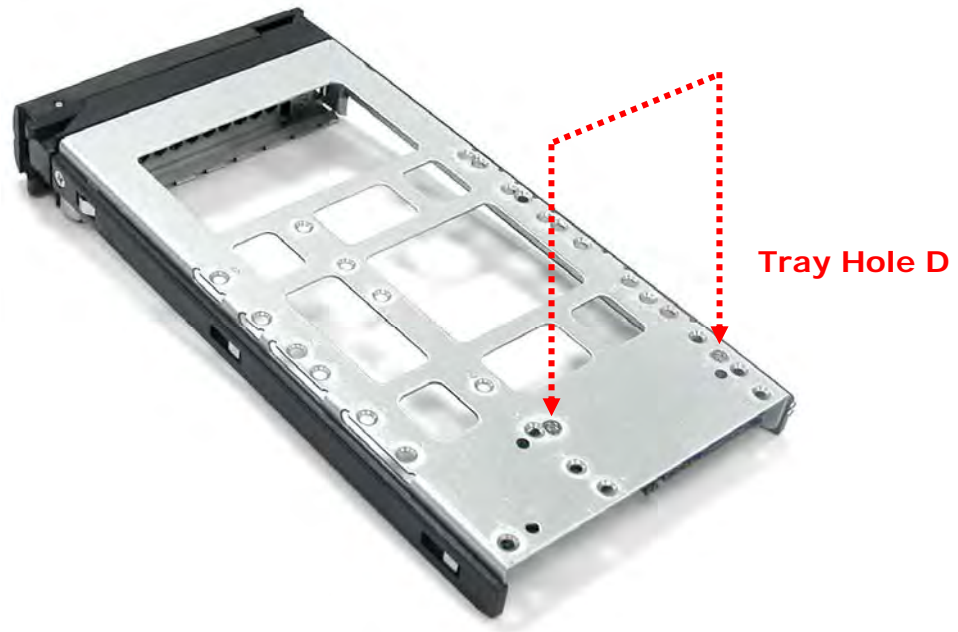

**NOTE: All the disk tray holes are labelled accordingly.**

4. Place the SATA disk drive into the disk tray. Slide the disk drive towards the dongle board.



5. Turn the disk tray upside down. Align the four screw holes of the SATA disk drive in the four Hole C of the disk tray. To secure the disk drive into the disk tray, tighten four screws on these holes of the disk tray. Note in the picture below where the screws should be placed in the disk tray holes.

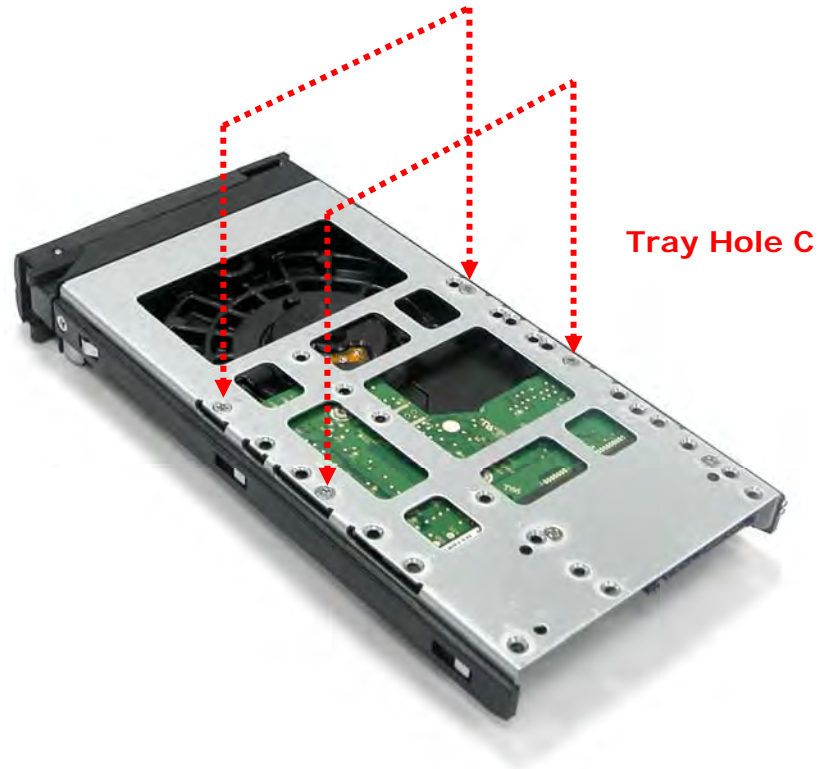

**NOTE: All the disk tray holes are labelled accordingly.**

6. Insert the disk tray into the subsystem.

### 3.4 iSCSI Introduction

iSCSI (Internet SCSI) is a protocol which encapsulates SCSI (Small Computer System Interface) commands and data in TCP/IP packets for linking storage devices with servers over common IP infrastructures. iSCSI provides high performance SANs over standard IP networks like LAN, WAN or the Internet.

IP SANs are true SANs (Storage Area Networks) which allow few of servers to attach to an infinite number of storage volumes by using iSCSI over TCP/IP networks. IP SANs can scale the storage capacity with any type and brand of storage system. In addition, using any type of network (Ethernet, Fast Ethernet, Gigabit Ethernet) and combining operating systems (Microsoft Windows, Linux, Solaris, ...etc.) within the SAN network. IP-SANs also include mechanisms for security, data replication, multi-path and high availability.

Storage protocol, such as iSCSI, has “two ends” in the connection. These ends are the initiator and the target. In iSCSI we call them iSCSI initiator and iSCSI target. The iSCSI initiator requests or initiates any iSCSI communication. It requests all SCSI operations like read or write. An initiator is usually located on the host/server side (either an iSCSI HBA or iSCSI SW initiator).

The iSCSI target is the storage device itself or an appliance which controls and serves volumes or virtual volumes. The target is the device which performs SCSI commands or bridges it to an attached storage device. iSCSI targets can be disks, tapes, RAID arrays, tape libraries, and etc.

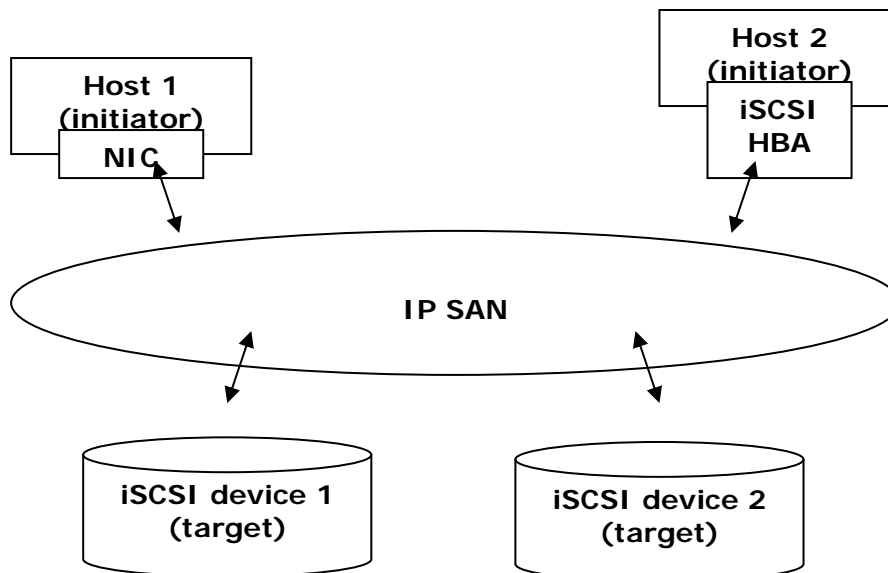

The host side needs an iSCSI initiator. The initiator is a driver which handles the SCSI traffic over iSCSI. The initiator can be software or hardware (HBA). Please refer to the certification list of iSCSI HBA(s) in Appendix A. OS native initiators or other software initiators use the standard TCP/IP stack and Ethernet hardware, while iSCSI HBA(s) use their own iSCSI and TCP/IP stacks on board.

Hardware iSCSI HBA(s) would provide its initiator tool. Please refer to the vendors' HBA user manual. **Microsoft**, **Linux** and **Mac** provide software iSCSI initiator driver. Below are the available links:

1. Link to download the Microsoft iSCSI software initiator:

<http://www.microsoft.com/downloads/details.aspx?FamilyID=12cb3c1a-15d6-4585-b385-befd1319f825&DisplayLang=en>

Please refer to Appendix D for Microsoft iSCSI initiator installation procedure.

2. Linux iSCSI initiator is also available. For different kernels, there are different iSCSI drivers. If you need the latest Linux iSCSI initiator, please visit Open-iSCSI project for most update information. Linux-iSCSI (sfnet) and Open-iSCSI projects merged in April 11, 2005.

**Open-iSCSI website:** <http://www.open-iscsi.org/>

**Open-iSCSI README:** <http://www.open-iscsi.org/docs/README>

**Features:** <http://www.open-iscsi.org/cgi-bin/wiki.pl/Roadmap>

**Support Kernels:** [http://www.open-iscsi.org/cgi-bin/wiki.pl/Supported\\_Kernels](http://www.open-iscsi.org/cgi-bin/wiki.pl/Supported_Kernels)

**Google groups:** <http://groups.google.com/group/open-iscsi/threads?gvc=2>

<http://groups.google.com/group/open-iscsi/topics>

**Open-iSCSI Wiki:** <http://www.open-iscsi.org/cgi-bin/wiki.pl>

3. ATTO iSCSI initiator is available for Mac.

**Website:** <http://www.attotech.com/xtend.html>

4. Solaris iSCSI Initiator

**Version:** Solaris 10 u6 (10/08)

## Chapter 4 Quick Setup

### 4.1 Management Interfaces

There are three management methods to manage the iSCSI RAID subsystem described as follows:

#### 4.1.1 Serial Console Port

Use NULL modem cable to connect console port.

The console settings are on the following:

Baud rate: **115200**, 8 bits, 1 stop bit, no parity, and no flow control.

Terminal type: **vt100**

Login name: **admin**

Default password: **00000000**

#### 4.1.2 Remote Control – Secure Shell

SSH (secure shell) is required for remote login. The SSH client software is available at the following web site:

SSHWinClient WWW: <http://www.ssh.com/>

Putty WWW: <http://www.chiark.greenend.org.uk/>

Host name: **192.168.10.50 (Please check your DHCP address for this field.)**

Login name: **admin**

Default password: **00000000**



**NOTE: This iSCSI RAID Series only support SSH for remote control. For using SSH, the IP address and the password is required for login.**

### 4.1.3 LCD Control Module (LCM)

After booting up the system, the following screen shows management port IP and model name:

**192.168.10.50**  
**iSCSI-Model**

Press **“Enter”** button, the LCM functions **“System Info.”**, **“Alarm Mute”**, **“Reset/Shutdown”**, **“Quick Install”**, **“Volume Wizard”**, **“View IP Setting”**, **“Change IP Config”** and **“Reset to Default”** will rotate by pressing **▲** (up) and **▼** (down).

When there is WARNING event or ERROR event occurred (LCM default filter), the LCM shows the event log to give users more detail from front panel.

The following table is the function description of LCM menus.

<b>System Info</b>	Displays System information.
<b>Alarm Mute</b>	Mute alarm when error occurs.
<b>Reset/Shutdown</b>	Reset or shutdown controller.
<b>Quick Install</b>	Quick three steps to create a volume. Please refer to next chapter for operation in web UI.
<b>Volume Wizard</b>	Smart steps to create a volume. Please refer to next chapter for operation in web UI.
<b>View IP Setting</b>	Display current IP address, subnet mask, and gateway.
<b>Change IP Config</b>	Set IP address, subnet mask, and gateway. There are 2 selections, DHCP (Get IP address from DHCP server) or set static IP.
<b>Reset to Default</b>	Reset to default sets password to default: <b>00000000</b> , and set IP address to default as DHCP setting.

The following is LCM menu hierarchy.

proIPS ▲▼	[System Info.]	[Firmware Version x.x.x]			
		[RAM Size xxx MB]			
	[Alarm Mute]	[▲Yes No▼]			
	[Reset/Shutdown]	[Reset]	[▲Yes No▼]		
		[Shutdown]	[▲Yes No▼]		
	[Quick Install]	RAID 0 RAID 1 RAID 3 RAID 5 RAID 6 RAID 0+1 xxx GB	[Apply The Config]	[▲Yes No▼]	
	[Volume Wizard]	[Local] RAID 0 RAID 1 RAID 3 RAID 5 RAID 6 RAID 0+1	[Use default algorithm]	[Volume Size] xxx GB	[Apply The Config] [▲Yes No▼]
		[JBOD x] ▲▼ RAID 0 RAID 1 RAID 3 RAID 5 RAID 6 RAID 0+1	[new x disk] ▲▼ xxx BG	Adjust Volume Size	[Apply The Config] [▲Yes No▼]
	[View IP Setting]	[IP Config] [Static IP]			
		[IP Address] [192.168.010.050]			
		[IP Subnet Mask] [255.255.255.0]			
		[IP Gateway] [192.168.010.254]			
	[Change IP Config]	[DHCP]	[▲Yes No▼]		
		[Static IP]	[IP Address]	Adjust IP address	
			[IP Subnet Mask]	Adjust Submask IP	
[IP Gateway]			Adjust Gateway IP		
[Apply IP Setting]			[▲Yes No▼]		
[Reset to Default]	[▲Yes No▼]				



**CAUTION! Before power off, it is better to execute "Shutdown" to flush the data from cache to physical disks.**

#### 4.1.4 Web GUI

The iSCSI RAID subsystem supports graphical user interface (GUI) to operate the system. Be sure to connect the LAN cable. The default IP setting is **DHCP**; open the browser and enter:

**http://192.168.10.50 (Please check the DHCP address first on LCM)**

Click any function at the first time; it will pop up a dialog window for authentication.

User name: **admin**

Default password: 00000000

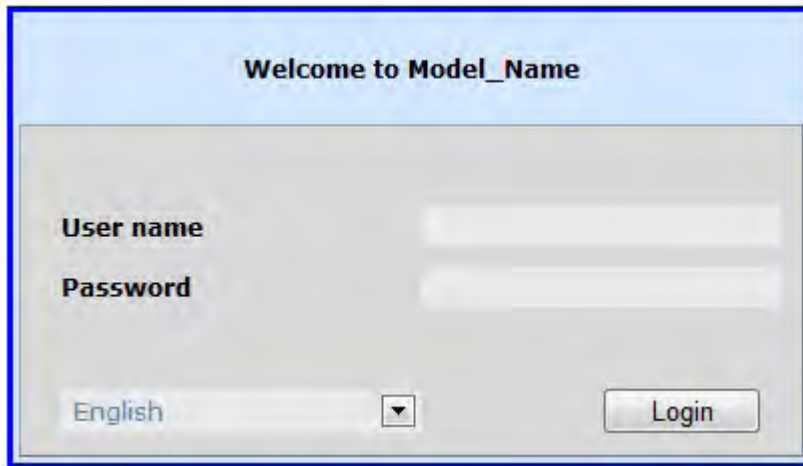



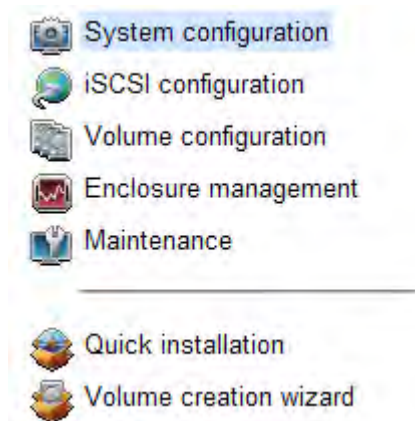





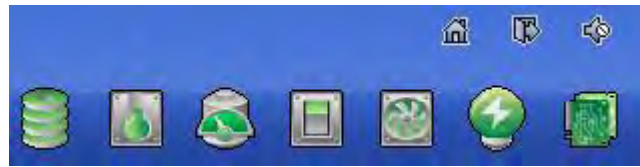

After login, you can choose the function blocks on the left side of window to do configuration.





There are seven indicators at the top-right corner.



	<p>RAID light:</p> <ul style="list-style-type: none"> <li>• <b>Green</b> → RAID works well.</li> <li>• <b>Red</b> → RAID fails.</li> </ul>
	<p>Temperature light:</p> <ul style="list-style-type: none"> <li>• <b>Green</b> → Temperature is normal.</li> <li>• <b>Red</b> → Temperature is abnormal.</li> </ul>
	<p>Voltage light:</p> <ul style="list-style-type: none"> <li>• <b>Green</b> → voltage is normal.</li> <li>• <b>Red</b> → voltage is abnormal.</li> </ul>
	<p>UPS light:</p> <ul style="list-style-type: none"> <li>• <b>Green</b> → UPS works well.</li> <li>• <b>Red</b> → UPS fails.</li> </ul>
	<p>Fan light:</p> <ul style="list-style-type: none"> <li>• <b>Green</b> → Fan works well.</li> <li>• <b>Red</b> → Fan fails.</li> </ul>
	<p>Power light:</p> <ul style="list-style-type: none"> <li>• <b>Green</b> → Power works well.</li> <li>• <b>Red</b> → Power fails.</li> </ul>
	<p>Dual controller light:</p> <ul style="list-style-type: none"> <li>• <b>Green</b> → Both controller1 and controller2 are present and well.</li> <li>• <b>Orange</b> → The system is degraded and there is only 1 controller alive and well.</li> </ul>
	Return to home page.
	Logout the management web UI.
	Mute alarm beeper.

## 4.2 How to Use the System Quickly

### 4.2.1 Quick Installation

It is easy to use **“Quick installation”** to create a volume. It uses all available physical disks to create a RG; the system will calculate maximum spaces on RAID levels 0/1/3/5/6/0+1. **“Quick installation”** will occupy all residual RG space for one VD, and it has no space for snapshot and spare. If snapshot is needed, please create volumes manually, and refer to Section 4.4 for more detail. If some physical disks are used in other RGs, **“Quick installation”** cannot be run because the operation is valid only when all physical disks in this system are free.

	Slot	Size(GB)	RG	Status	Health	Usage	Vendor	Serial	Type	Write cache	Standby	Readahead	Command queuing
OP	1	279		Online	Good	Free disk	WDC	WD-WXLY08094604	SATA2	Enabled	Disabled	Enabled	Disabled
OP	2	232		Online	Good	Free disk	Seagate	5QE3MPBG	SATA	Enabled	Disabled	Enabled	Disabled
OP	3	76		Online	Good	Free disk	Hitachi	PFDB30S2US713M	SATA2	Enabled	Disabled	Enabled	Disabled
OP	4	232		Online	Good	Free disk	Seagate	9SF0M2FT	SATA2	Enabled	Disabled	Enabled	Disabled
OP	5	232		Online	Good	Free disk	Hitachi	VDK41BT4CBWWUE	SATA2	Enabled	Disabled	Enabled	Disabled
OP	6	279		Online	Good	Free disk	WDC	WD-WXLY08093882	SATA2	Enabled	Disabled	Enabled	Disabled
OP	7	76		Online	Good	Free disk	Hitachi	PFDB30S4R6HVKM	SATA2	Enabled	Disabled	Enabled	Disabled
OP	8	232		Online	Good	Free disk	Seagate	9SF0PBQV	SATA2	Enabled	Disabled	Enabled	Disabled

**Step 1:** Click **“Quick installation”** menu item. Follow the steps to set up system name and date/time.

**Quick installation**

**Step 1 : System setting**

---

**System name**

System name : model-name

---

**Date and time**

Change date and time

Current time : 2011/11/21 12:28:59

Time zone : (GMT-05:00) Eastern Time(US & Canada)

Setup date and time manually

Date : 2011 / 11 / 21

Time : 12 : 28 : 44

NTP

Server :

---

Cancel Next >>

**Step2:** Confirm the management port IP address and DNS, and then click **“Next”**.

Quick installation

**Step 2 : Network setting**

**MAC address**

MAC address : 00:13:78:B5:03:80

**Address**

DHCP  
 Static

Address : 192.168.10.176

Mask : 255.255.255.0

Gateway :

**DNS**

DNS :

**Port**

HTTP port : 80

HTTPS port : 443

SSH port : 22

Cancel << Back Next >>

**Step 3:** Set up the data port IP and click **“Next”**.

Quick installation

**Step 3 : iSCSI IP address**

**LAN1:**

DHCP  
 Static

Address : 192.168.1.63

Mask : 255.255.255.0

Gateway : 192.168.1.254

Cancel << Back Next >>

**Step 4:** Set up the RAID level and volume size and click **“Next”**.

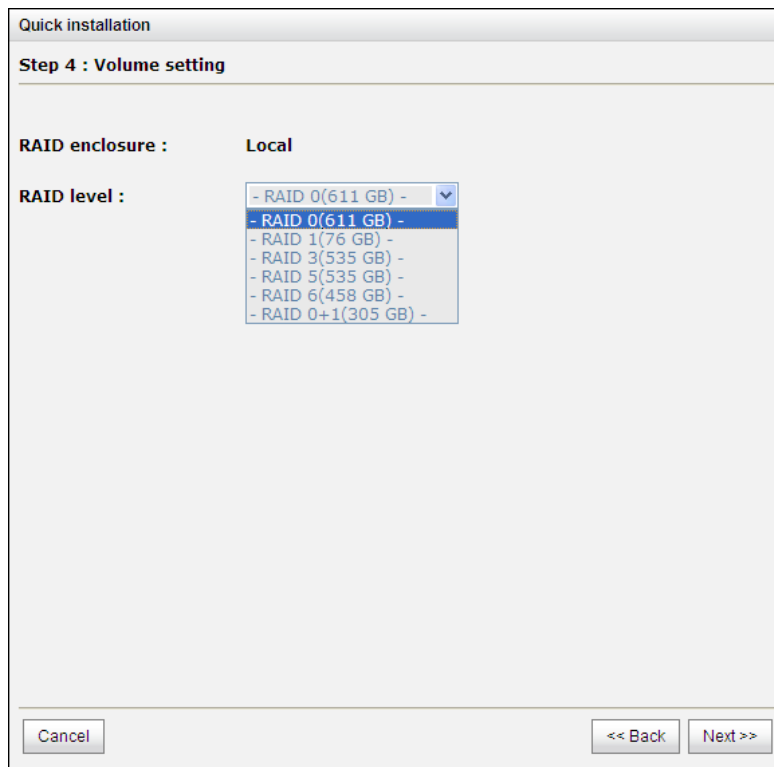

**Step 5:** Check all items, and click **“Finish”**.



**Step 6:** Done.

## 4.2.2 Volume Creation Wizard

“**Volume create wizard**” has a smarter policy. When the system is inserted with some HDDs. “**Volume create wizard**” lists all possibilities and sizes in different RAID levels, it will use all available HDDs for RAID level depends on which user chooses. When system has different sizes of HDDs, e.g., 8\*200G and 8\*80G, it lists all possibilities and combination in different RAID level and different sizes. After user chooses RAID level, user may find that some HDDs are available (free status). It gives user:

1. Biggest capacity of RAID level for user to choose and,
2. The fewest disk number for RAID level / volume size.

E.g., user chooses RAID 5 and the controller has 8\*200G + 4\*80G HDDs inserted. If we use all 12 HDDs for a RAID 5, and then the maximum size of volume is 880G (80G\*11). By the wizard, we do smarter check and find out the most efficient way of using HDDs. The wizard only uses 200G HDDs (Volume size is 200G\*7=1400G), the volume size is bigger and fully uses HDD capacity.

**Step 1:** Select “**Volume create wizard**” and then choose the RAID level. After the RAID level is chosen, click “**Next**”.

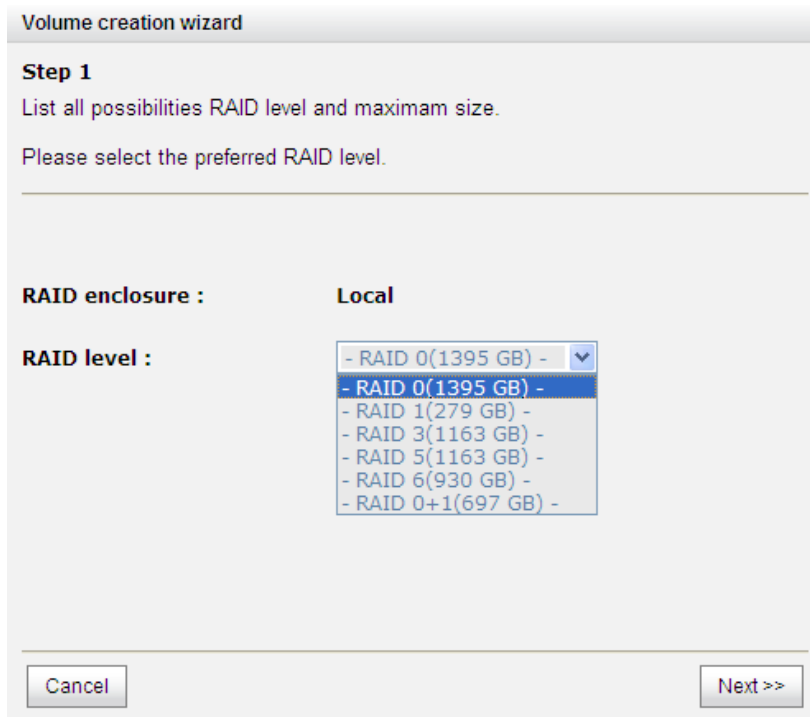

**Step 2:** Please select the combination of the RG capacity, or **“Use default algorithm”** for maximum RG capacity. After RG size is chosen, click **“Next”**.

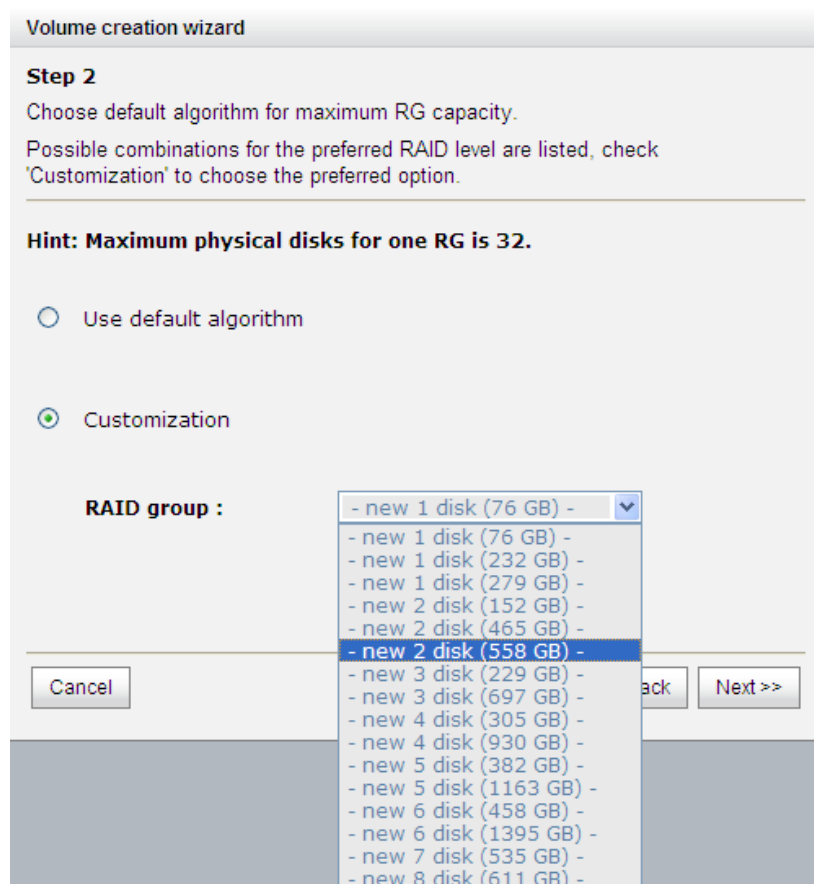

**Step 3:** Decide VD size. User can enter a number less or equal to the default number. Then click **“Next”**.

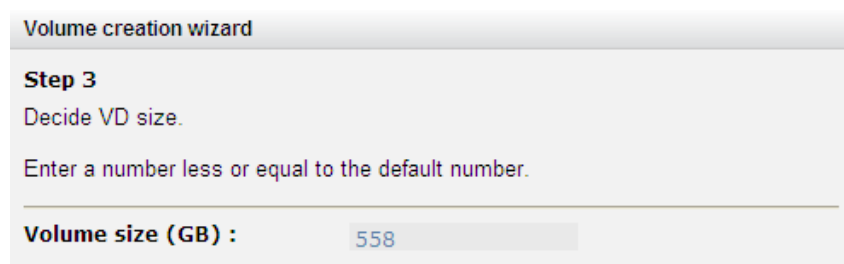

**Step 4:** Confirmation page. Click **“Finish”** if all setups are correct. Then a VD will be created.

**Volume creation wizard**

**Confirm**  
Please confirm the setting, and click 'Finish' to create a new virtual disk.

---

**RAID level :** RAID 0

**RAID group :** new rg

**Volume size (GB) :** 558

---

**Step 5:** Done. The system is available now.

	Name	Size(GB)	Write	Priority	Bg rate	Type	Clone	Schedule	Status	Health	R %	RAID	#LUN	Snapshot space(GB)	#Snapshot	RG
OP:	QUICK71147	1862	WB	HI	4	RAID	N/A	N/A	Online	Optimal		RAID 0	1	0/0	0	QUICK42321



**NOTE: A virtual disk of RAID 0 is created and is named by system itself.**

## Chapter 5 Configuration

### 5.1 Web GUI Management Interface Hierarchy

The below table is the hierarchy of the management GUI.

#### System configuration

- System setting** → System name / Date and time / System indication
- Network setting** → MAC address / Address / DNS / Port
- Login setting** → Login configuration / Admin password / User password
- Mail setting** → Mail
- Notification setting** → SNMP / Messenger / System log server / Event log filter

#### iSCSI configuration

- NIC** → Show information for: (Controller 1/ Controller 2) Aggregation / IP settings for iSCSI ports / Become default gateway / Enable jumbo frame / Ping host
- Entity property** → Entity name / iSNS IP
- Node** → Show information for: (Controller 1/ Controller 2) Authenticate / Change portal / Rename alias/ User
- Session** → Show information for: (Controller 1/ Controller 2) List connection / Delete
- CHAP account** → Create / Modify user information / Delete

#### Volume configuration

- Physical disk** → Set Free disk / Set Global spare / Set Dedicated spare / Upgrade / Disk Scrub / Turn on/off the indication LED / More information
- RAID group** → Create / Migrate / Activate / Deactivate / Parity check / Delete / Set preferred owner / Set disk property / More information
- Virtual disk** → Create / Extend / Parity check / Delete / Set property / Attach LUN / Detach LUN / List LUN / Set clone / Clear clone / Start clone / Stop clone / Schedule clone / Set snapshot space / Cleanup snapshot / Take snapshot / Auto snapshot / List snapshot / More information
- Snapshot** → Set snapshot space / Auto snapshot / Take snapshot / Export / Rollback / Delete/ Cleanup snapshot
- Logical unit** → Attach / Detach/ Session

#### Enclosure management

- Hardware monitor** → Controller 1 / BPL / Controller 2 / Auto shutdown
- UPS** → UPS Type / Shutdown battery level / Shutdown delay / Shutdown UPS
- SES** → Enable / Disable
- S.M.A.R.T.** → S.M.A.R.T. information (**Only for SATA hard drives**)

#### Maintenance

- System information** → System information
- Event log** → Download / Mute / Clear
- Upgrade** → Browse the firmware to upgrade



- Firmware synchronization** → Synchronize the slave controller's firmware version with the master's
- Reset to factory default** → Sure to reset to factory default?
- Import and export** Import/Export / Import file
- Reboot and shutdown** → Reboot / Shutdown

**Quick installation**

Step 1 / Step 2 / Step 3 / Step 4 / Confirm

**Volume creation wizard**

Step 1 / Step 2 / Step 3 / Confirm

## 5.2 System Configuration

“System configuration” is designed for setting up the “System setting”, “Network setting”, “Login setting”, “Mail setting”, and “Notification setting”.

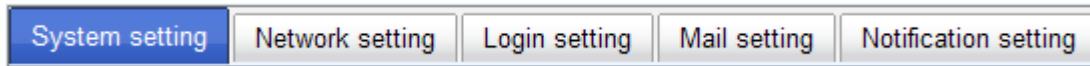

### 5.2.1 System Setting

“System setting” can be used to set system name and date. Default “System name” is composed of model name and serial number of this system.

Check “Change date and time” to set up the current date, time, and time zone before using or synchronize time from NTP (Network Time Protocol) server. Click “Confirm” in System indication to turn on the system indication LED. Click again to turn off.

## 5.2.2 Network Setting

“**Network setting**” is for changing IP address for remote administration usage. There are 2 options, DHCP (Get IP address from DHCP server) and static IP. The default setting is DHCP. User can change the HTTP, HTTPS, and SSH port number when the default port number is not allowed on host/server.

System setting	Network setting	Login setting	Mail setting	Notification setting
<p><b>Setup MAC, address, DNS and ports.</b></p> <p>You can check 'DHCP' to acquire IP address from DHCP server, or check 'Static' to setup IP address.</p>				
<p><b>MAC address</b></p> <p>MAC address : 00:13:78:B5:03:80</p>				
<p><b>Address</b></p> <p> <input type="radio"/> DHCP  <input checked="" type="radio"/> Static         </p> <p>Address : 192.168.10.176</p> <p>Mask : 255.255.255.0</p> <p>Gateway :</p>				
<p><b>DNS</b></p> <p>DNS :</p>				
<p><b>Port</b></p> <p>HTTP port : 80</p> <p>HTTPS port : 443</p> <p>SSH port : 22</p>				
<p>Confirm</p>				

### 5.2.3 Login Setting

“**Login setting**” can set single admin, auto logout time and Admin/User password. The single admin can prevent multiple users access the same controller at the same time.

1. **Auto logout:** The options are (1) Disable; (2) 5 minutes; (3) 30 minutes; (4) 1 hour. The system will log out automatically when user is inactive for a period of time.
2. **Login lock:** Disable/Enable. When the login lock is enabled, the system allows only one user to login or modify system settings.

System setting | Network setting | **Login setting** | Mail setting | Notification setting

**Setup Login configuration and password.**

If Auto logout time is set, the system will log out automatically when user is inactive for a period of time. When the login lock is enabled, the system allows only one user to login or modify system settings.

**Login configuration**

Auto logout : - Disable -

Login lock : - Disable -

**Admin password**

Change admin password

Old password :

Password :

Confirm :

**User password**

Change user password

Password :

Confirm :

Confirm

Check “**Change admin password**” or “**Change user password**” to change admin or user password. The maximum length of password is 12 characters.

## 5.2.4 Mail Setting

“Mail setting” can accept at most 3 mail-to address entries for receiving the event notification. Some mail servers would check “Mail-from address” and need authentication for anti-spam. Please fill the necessary fields and click “Send test mail” to test whether email functions are available or working. User can also select which levels of event logs are needed to be sent via Mail. Default setting only enables ERROR and WARNING event logs. Please also make sure the DNS server IP is well-setup so the event notification mails can be sent successfully.

System setting
Network setting
Login setting
Mail setting
Notification setting

Enter at most 3 mail addresses for receiving the event notification. Some mail servers would check 'Mail-from address' and need authentication for anti-spam.  
After information is set, you can click 'Send test mail' to test whether email functions are available.

**Mail**

**Mail-from address :**

**Mail-to address 1 :**

**Send events1 :**  INFO  WARNING  ERROR

**Mail-to address 2 :**

**Send events2 :**  INFO  WARNING  ERROR

**Mail-to address 3 :**

**Send events3 :**  INFO  WARNING  ERROR

SMTP relay ▾

**SMTP server :**

**Authentication :**

**Account :**

**Password :**

**Confirm :**

## 5.2.5 Notification Setting

“**Notification setting**” can be used to set up SNMP trap for alerting via SNMP, pop-up message via Windows messenger (not MSN), alert via syslog protocol, and event log filter.

The screenshot shows the 'Notification setting' configuration page with the following sections and fields:

- SNMP**
  - SNMP trap address 1 : [Text Input]
  - SNMP trap address 2 : [Text Input]
  - SNMP trap address 3 : [Text Input]
  - Community : public [Text Input]
  - MIB file download : [Download Button]
  - Send events :  INFO  WARNING  ERROR
- Messenger**
  - Messenger IP/Computer name 1 : [Text Input]
  - Messenger IP/Computer name 2 : [Text Input]
  - Messenger IP/Computer name 3 : [Text Input]
  - Send events :  INFO  WARNING  ERROR
- System log server**
  - Server IP/hostname : [Text Input]
  - UDP Port : 514 [Text Input]
  - Facility : User [Dropdown Menu]
  - Event level :  INFO  WARNING  ERROR
- Event log filter**
  - Pop up events :  INFO  WARNING  ERROR
  - Show on LCM :  INFO  WARNING  ERROR
- Buzzer**
  - Always disable buzzer :

A 'Confirm' button is located at the bottom left of the page.

“**SNMP**” allows up to 3 SNMP trap addresses. Default community name is set as “public”. User can choose the event log levels and default setting only enables INFO event log in SNMP. There are many SNMP tools. The following web sites are for your reference:

SNMPc: <http://www.snmpc.com/>

Net-SNMP: <http://net-snmp.sourceforge.net/>

Using “**Messenger**”, user must enable the service “Messenger” in Windows (Start → Control Panel → Administrative Tools → Services → Messenger), and then event logs can be received. It allows up to 3 messenger addresses. User can choose the event log levels and default setting enables the WARNING and ERROR event logs.

Using **“System log server”**, user can choose the facility and the event log level. The default port of syslog is 514. The default setting enables event level: INFO, WARNING and ERROR event logs.

There are some syslog server tools. The following web sites are for your reference:

WinSyslog: <http://www.winsyslog.com/>

Kiwi Syslog Daemon: <http://www.kiwisyslog.com/>

Most UNIX systems have built-in syslog daemon.

**“Event log filter”** setting can enable event level on **“Pop up events”** and **“LCM”**.

**“Buzzer”** setting can disable buzzer.

The system buzzer features are described as follows:

1. The system buzzer alarms 1 second when system boots up successfully.
2. The system buzzer alarms continuously when there is error level event happened. The alarm will be stopped after mute.
3. The alarm will be muted automatically when the error situation is resolved. E.g., when RAID 5 is degraded and alarm sounds immediately, after user changes/adds one physical disk for rebuilding, and when the rebuilding is done, the alarm will be muted automatically.

### 5.3 iSCSI Configuration

**“iSCSI configuration”** is designed for setting up the **“Entity Property”**, **“NIC”**, **“Node”**, **“Session”**, and **“CHAP account”**.

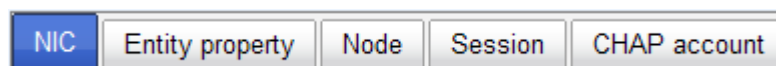

### 5.3.1 NIC

“NIC” function is used to change the IP addresses of iSCSI data ports. The iSCSI RAID subsystem has two 10GbE ports on each controller to transmit data. Each of them must be assigned to one IP address in multi-homed mode unless the link aggregation or trunking mode has been selected. When there are multiple data ports setting up in link aggregation or trunking mode, all the data ports share single address.

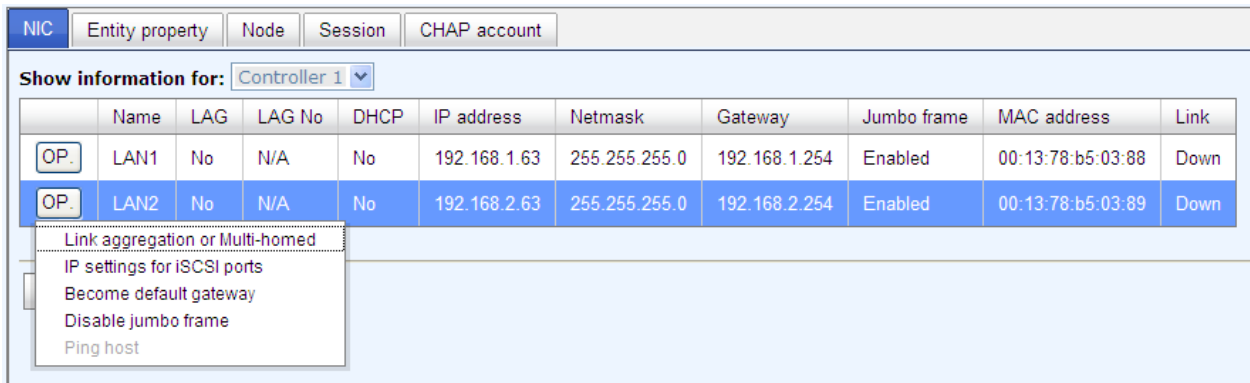

There are four iSCSI data ports on each controller. Four data ports are set with static IP.

#### IP settings:

User can change IP address by moving the mouse to the gray button of LAN port, click “IP settings for iSCSI ports”. There are 2 selections, DHCP (Get IP address from DHCP server) or static IP.

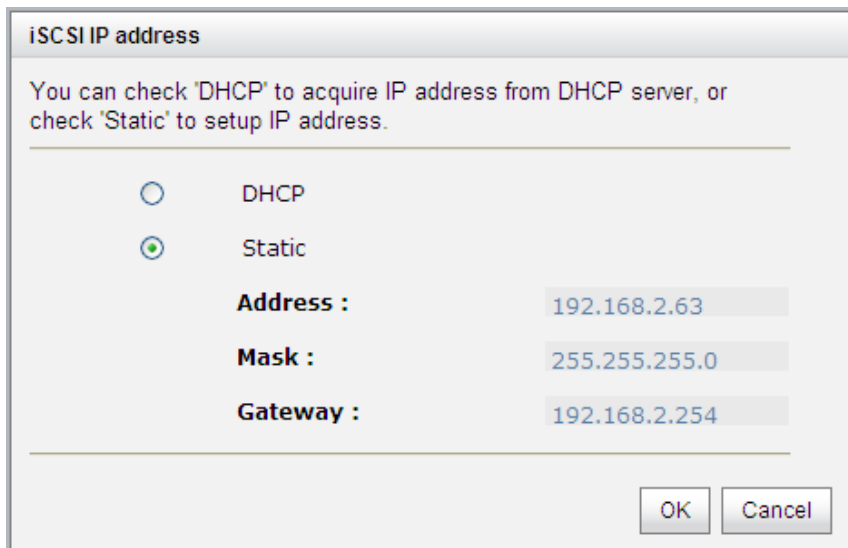

#### Default gateway:

Default gateway can be changed by moving the mouse to the gray button of LAN port, click “Become default gateway”. There is only one default gateway.



**MTU / Jumbo frame:**

**MTU (Maximum Transmission Unit)** size can be enabled by moving mouse to the gray button of LAN port, click **“Enable jumbo frame”**. Maximum jumbo frame size is **3900** bytes.



**WARNING! The MTU size of network switch and HBA on host must be enabled. Otherwise, the LAN connection will not work properly.**

**Multi-homed / Trunking / LACP:**

The following is the description of multi-homed/trunking/LACP.

1. **Multi-homed:** Default mode. Each of iSCSI data port is connected by itself and is not set to link aggregation and trunking. This function is also for Multipath functions. Selecting this mode can also remove the setting of Trunking/LACP at the same time.
2. **Trunking:** defines the use of multiple iSCSI data ports in parallel to increase the link speed beyond the limits of any single port.
3. **LACP:** The Link Aggregation Control Protocol (LACP) is part of IEEE specification 802.3ad that allows bundling several physical ports together to form a single logical channel. LACP allows a network switch to negotiate an automatic bundle by sending LACP packets to the peer. The advantages of LACP are: (1) increase in bandwidth, and (2) failover when link status fails on a port.

Trunking/LACP setting can be changed by clicking the button **“Aggregation”**.

There are 2 iSCSI data ports. Select at least two NICs for link aggregation.

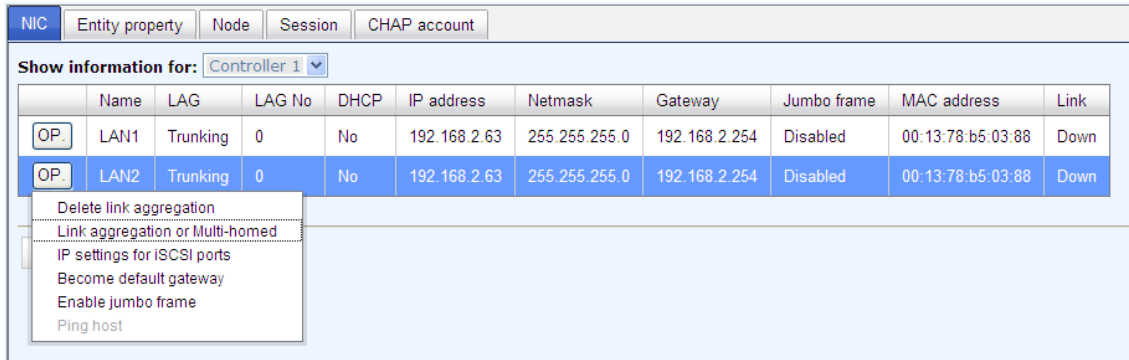

For example, LAN1 and LAN2 are set to Trunking mode. To remove Trunking/LACP setting, check the gray button of LAN port, click **“Delete link aggregation”**. Then it will pop up a message to confirm.

**Ping host:**

User can ping the corresponding host data port from the target, click **“Ping host”**.

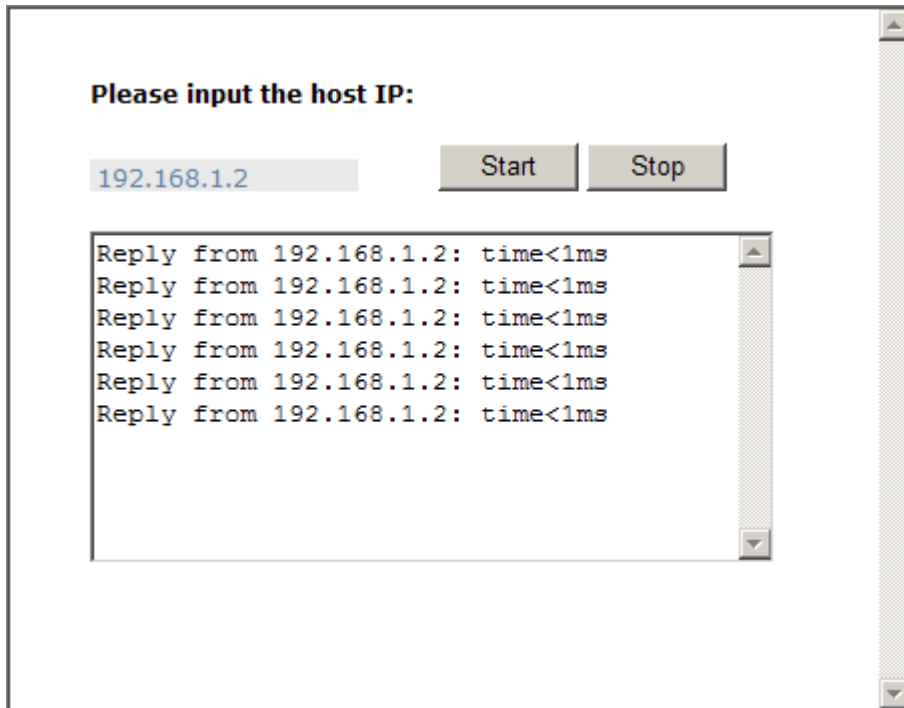

A user can ping host from the target to make sure the data port connection is well.

### 5.3.2 Entity Property

“**Entity property**” is used to view the entity name of the iSCSI RAID subsystem, and setup “**iSNS IP**” for iSNS (Internet Storage Name Service). iSNS protocol allows automated discovery, management and configuration of [iSCSI](#) devices on a [TCP/IP](#) network. Using iSNS, it requires that an iSNS server be setup in the SAN. Add an iSNS server IP address into iSNS server lists in order that iSCSI initiator service can send queries.

**Setup the entity name and iSNS IP.**

iSNS protocol allows automated discovery, management and configuration of iSCSI devices on a TCP/IP network. Add an iSNS server IP address into iSNS server lists in order that iSCSI initiator service can send queries.

<b>Entity name :</b>	<input type="text"/>
<b>iSNS IP :</b>	<input type="text"/>

### 5.3.3 Node

“Node” can be used to view the target name for iSCSI initiator. The iSCSI RAID subsystem supports up to 32 multinodes. There are 32 default nodes created for each controller.

	ID	Auth	Name	Portal	Alias
<input type="button" value="OP."/>	0	None	iqn.1997-05.tw.com.proware:proips-fff9014d8.dev0.ctr1	192.168.1.1:3260, 192.168.2.1:3260	
<input type="button" value="OP."/>	1	None	iqn.1997-05.tw.com.proware:proips-fff9014d8.dev1.ctr1	192.168.1.1:3260, 192.168.2.1:3260	
<input type="button" value="OP."/>	2	None	iqn.1997-05.tw.com.proware:proips-fff9014d8.dev2.ctr1	192.168.1.1:3260, 192.168.2.1:3260	
<input type="button" value="OP."/>	3	None	iqn.1997-05.tw.com.proware:proips-fff9014d8.dev3.ctr1	192.168.1.1:3260, 192.168.2.1:3260	
<input type="button" value="OP."/>	4	None	iqn.1997-05.tw.com.proware:proips-fff9014d8.dev4.ctr1	192.168.1.1:3260, 192.168.2.1:3260	
<input type="button" value="OP."/>	5	None	iqn.1997-05.tw.com.proware:proips-fff9014d8.dev5.ctr1	192.168.1.1:3260, 192.168.2.1:3260	
<input type="button" value="OP."/>	6	None	iqn.1997-05.tw.com.proware:proips-fff9014d8.dev6.ctr1	192.168.1.1:3260, 192.168.2.1:3260	
<input type="button" value="OP."/>	7	None	iqn.1997-05.tw.com.proware:proips-fff9014d8.dev7.ctr1	192.168.1.1:3260, 192.168.2.1:3260	
<input type="button" value="OP."/>	8	None	iqn.1997-05.tw.com.proware:proips-fff9014d8.dev8.ctr1	192.168.1.1:3260, 192.168.2.1:3260	
<input type="button" value="OP."/>	9	None	iqn.1997-05.tw.com.proware:proips-fff9014d8.dev9.ctr1	192.168.1.1:3260, 192.168.2.1:3260	
<input type="button" value="OP."/>	10	None	iqn.1997-05.tw.com.proware:proips-fff9014d8.dev10.ctr1	192.168.1.1:3260, 192.168.2.1:3260	
<input type="button" value="OP."/>	11	None	iqn.1997-05.tw.com.proware:proips-fff9014d8.dev11.ctr1	192.168.1.1:3260, 192.168.2.1:3260	

#### CHAP:

**CHAP** is the abbreviation of **C**hallenge **H**andshake **A**uthorization **P**rotocol. CHAP is a strong authentication method used in point-to-point for user login. It's a type of authentication in which the authentication server sends the client a key to be used for encrypting the username and password. CHAP enables the username and password to transmitting in an encrypted form for protection.

To use CHAP authentication, please follow these steps:

1. Select one of 32 default nodes from one controller.
2. Check the gray button of “OP.” column, click “Authenticate”.
3. Select “CHAP”.

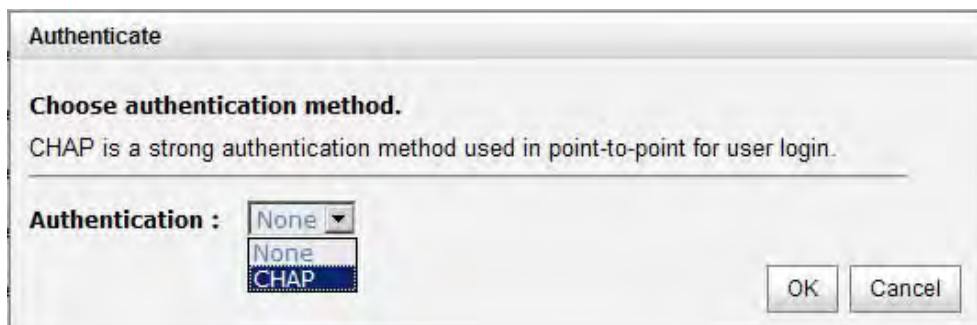

- Click **"OK"**.

NIC Entity property Node Session CHAP account					
Show information for: Controller 1					
<< first < prev 1 2 3 next > last >>					
	ID	Auth	Name	Portal	Alias
<input type="button" value="OP."/>	0	CHAP	iqn.1997-05.tw.com.proware:proips-fff9014d8:dev0.ctr1	192.168.1.1:3260, 192.168.2.1:3260	
<input type="button" value="OP."/>	1	CHAP	iqn.1997-05.tw.com.proware:proips-fff9014d8:dev1.ctr1	192.168.1.1:3260, 192.168.2.1:3260	
<input type="button" value="OP."/>	2	None	iqn.1997-05.tw.com.proware:proips-fff9014d8:dev2.ctr1	192.168.1.1:3260, 192.168.2.1:3260	
<input type="button" value="OP."/>	3	None	iqn.1997-05.tw.com.proware:proips-fff9014d8:dev3.ctr1	192.168.1.1:3260, 192.168.2.1:3260	
<input type="button" value="OP."/>	4	None	iqn.1997-05.tw.com.proware:proips-fff9014d8:dev4.ctr1	192.168.1.1:3260, 192.168.2.1:3260	

- Go to **" / iSCSI configuration / CHAP account "** page to create CHAP account. Please refer to next section for more detail.
- Check the gray button of **"OP."** column, click **"User"**.
- Select CHAP user(s) which will be used. It's a multi option; it can be one or more. If choosing none, CHAP cannot work.

**User**

**Select CHAP user(s).**

Select CHAP user(s) which will be used for this node. it can be one or more. If choosing none, CHAP will not work.

**Node :**                    **iqn.1997-05.tw.com.proware:proips-fff9014d8:dev0.ctr1**

	User
<input checked="" type="checkbox"/>	chap1
<input checked="" type="checkbox"/>	chap2

- Click **"OK"**.
- In **"Authenticate"** of **"OP"** page, select **"None"** to disable CHAP.

### Change portal:

Users can change the portals belonging to the device node of each controller.

1. Check the gray button of **"OP."** column next to one device node.
2. Select **"Change portal"**.
3. Choose the portals for the controller.
4. Click **"OK"** to confirm.

### Rename alias:

User can create an alias to one device node.

1. Check the gray button of **"OP."** column next to one device node.
2. Select **"Rename alias"**.
3. Create an alias for that device node.
4. Click **"OK"** to confirm.
5. An alias appears at the end of that device node.

NIC Entity property Node Session CHAP account					
Show information for: Controller 1					
<< first < prev 1 2 3 next > last >>					
	ID	Auth	Name	Portal	Alias
	0	CHAP	iqn.1997-05.tw.com.proware:proips-fff9014d8:dev0.ctr1	192.168.1.1:3260, 192.168.2.1:3260	dev0.ctr1
	1	CHAP	iqn.1997-05.tw.com.proware:proips-fff9014d8:dev1.ctr1	192.168.1.1:3260, 192.168.2.1:3260	
	2	None	iqn.1997-05.tw.com.proware:proips-fff9014d8:dev2.ctr1	192.168.1.1:3260, 192.168.2.1:3260	
	3	None	iqn.1997-05.tw.com.proware:proips-fff9014d8:dev3.ctr1	192.168.1.1:3260, 192.168.2.1:3260	
	4	None	iqn.1997-05.tw.com.proware:proips-fff9014d8:dev4.ctr1	192.168.1.1:3260, 192.168.2.1:3260	



**NOTE: After setting CHAP, the initiator in host/server should be set the same CHAP account. Otherwise, user cannot login.**

### 5.3.4 Session

“**Session**” can display iSCSI session and connection information, including the following items:

1. TSIH (target session identifying handle)
2. Host (Initiator Name)
3. Controller (Target Name)
4. InitialR2T(Initial Ready to Transfer)
5. Immed. data(Immediate data)
6. MaxDataOutR2T(Maximum Data Outstanding Ready to Transfer)
7. MaxDataBurstLen(Maximum Data Burst Length)
8. DataSeqInOrder(Data Sequence in Order)
9. DataPDUInOrder(Data PDU in Order)
10. Detail of Authentication status and Source IP: port number.

No.	TSIH	Initiator name	Target name	InitialR2T	Immed. data	MaxOutR2T	MaxDataBurstLen	DataSeqInOrder	DataPDUInOrder
0	0x0001	iqn.1991-05.com.microsoft.sdfs-56745d1467	iqn.1997-05.tw.com.proware.proips-ff9014d8.dev0.ctr1	Yes	Yes	1	262144	Yes	Yes

Check the gray button of session number, click “**List connection**”. It will list all connection(s) of the session.

No.	Initiator IP	Initiator name	MaxRecvDataSegLen	MaxTransDataSegLen	Authentication
1	192.168.1.59	iqn.1991-05.com.microsoft.sdfs-56745d1467	16384	65536	No

### 5.3.5 CHAP Account

“**CHAP account**” is used to manage CHAP accounts for authentication. This iSCSI RAID subsystem allows creation of many CHAP accounts.

To setup CHAP account, please follow these steps:

1. Click “**Create**”.
2. Enter “**User**”, “**Secret**”, and “**Confirm**” secret again. “**Node**” can be selected here or later. If selecting none, it can be enabled later in “/ iSCSI configuration / Node / User”.

3. Click “**OK**”.

	User	ID
OP.	chap1	0

4. Click “**Delete**” to delete CHAP account.



## 5.4 Volume Configuration

“Volume configuration” is designed for setting up the volume configuration which includes “Physical disk”, “RAID group”, “Virtual disk”, “Snapshot”, and “Logical unit”.

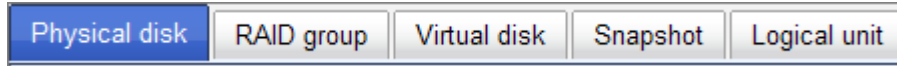

### 5.4.1 Physical Disk

“Physical disk” can be used to view the status of hard drives in the system. The following are operational tips:

1. Check the gray button next to the number of slot, it will show the functions which can be executed.
2. Active function can be selected, and inactive functions show up in gray color and cannot be selected.

For example, set PD slot number 8 to dedicated spare disk.

**Step 1:** Check the gray button of PD 8, select “Set Dedicated spare”, it will link to next page.

	Slot	Size(GB)	RG	Status	Health	Usage	Vendor	Serial	Type	Write cache	Standby	Readahead	Command queuing
OP	1	279	RG-R5	Online	Good	RAID disk	WDC	WD-WXLY08094604	SATA2	Enabled	Disabled	Enabled	Disabled
OP	2	232	RG-R5	Online	Good	RAID disk	Seagate	5QE3MPBG	SATA	Enabled	Disabled	Enabled	Disabled
OP	3	76	RG-R5	Online	Good	RAID disk	Hitachi	PFDB30S2US713M	SATA2	Enabled	Disabled	Enabled	Disabled
OP	4	232		Online	Good	Free disk	Seagate	9SF0M2FT	SATA2	Enabled	Disabled	Enabled	Disabled
				Online	Good	Free disk	Hitachi	VDK41BT4CBWWWUE	SATA2	Enabled	Disabled	Enabled	Disabled
				Online	Good	Free disk	WDC	WD-WXLY08093882	SATA2	Enabled	Disabled	Enabled	Disabled
				Online	Good	Free disk	Hitachi	PFDB30S4R6HVKM	SATA2	Enabled	Disabled	Enabled	Disabled
				Online	Good	Free disk	Seagate	9SF0PBQV	SATA2	Enabled	Disabled	Enabled	Disabled

**Step 2:** Maybe there are some existing RGs which can be assigned dedicate spare disk. Select which RG will be assigned, then click “Submit”.

No.	Name	Total	Free	#PD	#VD	Status	Health	RAID
1	RG-R5	152	152	3	0	Online	Good	RAID 5

**Step 3:** Done. View “Physical disk” page.

**Physical Disk:**

Physical disk													
RAID group													
Virtual disk													
Snapshot													
Logical unit													
Show PD for: <span>- Local -</span> Show size unit as: <span>(GB)</span>													
Slot	Size(GB)	RG	Status	Health	Usage	Vendor	Serial	Type	Write cache	Standby	Readahead	Command queuing	
<input type="checkbox"/>	1	279	RG-R5	Online	Good	RAID disk	WDC	WD-WXLY08094604	SATA2	Enabled	Disabled	Enabled	Disabled
<input type="checkbox"/>	2	232	RG-R5	Online	Good	RAID disk	Seagate	5QE3MPBG	SATA	Enabled	Disabled	Enabled	Disabled
<input type="checkbox"/>	3	76	RG-R5	Online	Good	RAID disk	Hitachi	PFDB30S2US713M	SATA2	Enabled	Disabled	Enabled	Disabled
<input type="checkbox"/>	4	232	RG-R5	Online	Good	Dedicated spare	Seagate	9SF0M2FT	SATA2	Enabled	Disabled	Enabled	Disabled
<input type="checkbox"/>	5	232		Online	Good	Free disk	Hitachi	VDK41BT4CBWWUE	SATA2	Enabled	Disabled	Enabled	Disabled
<input type="checkbox"/>	6	279		Online	Good	Free disk	WDC	WD-WXLY08093882	SATA2	Enabled	Disabled	Enabled	Disabled
<input type="checkbox"/>	7	76		Online	Good	Free disk	Hitachi	PFDB30S4R6HVKM	SATA2	Enabled	Disabled	Enabled	Disabled
<input type="checkbox"/>	8	232		Online	Good	Free disk	Seagate	9SF0PBQV	SATA2	Enabled	Disabled	Enabled	Disabled

Physical disks in slot 1, 2, 3 are created for a RG named "RG-R5". Slot 4 is set as dedicated spare disk of the RG named "RG-R5". The others are free disks.)

**Step 4:** The unit of size can be changed from (GB) to (MB). It will display the capacity of hard drive in MB.

Physical disk						
RAID group						
Virtual disk						
Snapshot						
Logical unit						
Show PD for: <span>- Local -</span> Show size unit as: <span>(MB)</span>						
Slot	Size(MB)	RG	Status	Health	Usage	
<input type="checkbox"/>	1	285912	RG-R5	Online	Good	RAID disk
<input type="checkbox"/>	2	238219	RG-R5	Online	Good	RAID disk
<input type="checkbox"/>	3	78277	RG-R5	Online	Good	RAID disk
<input type="checkbox"/>	4	238219	RG-R5	Online	Good	Dedicated spare
<input type="checkbox"/>	5	238219		Online	Good	Free disk
<input type="checkbox"/>	6	285912		Online	Good	Free disk
<input type="checkbox"/>	7	78277		Online	Good	Free disk
<input type="checkbox"/>	8	238219		Online	Good	Free disk

**PD column description:**

<b>Slot</b>	The position of hard drives. The button next to the number of slot shows the functions which can be executed.
<b>Size (GB) (MB)</b>	Capacity of hard drive.
<b>RG Name</b>	Related RAID group name.

<b>Status</b>	<p>The status of hard drive.</p> <p><b>"Online"</b> → the hard drive is online.</p> <p><b>"Rebuilding"</b> → the hard drive is being rebuilt.</p> <p><b>"Transition"</b> → the hard drive is being migrated or is replaced by another disk when rebuilding occurs.</p> <p><b>"Scrubbing"</b> → if the hard drive is being scrubbed.</p>
<b>Health</b>	<p>The health of hard drive.</p> <p><b>"Good"</b> → the hard drive is good.</p> <p><b>"Failed"</b> → the hard drive is failed.</p> <p><b>"Error Alert"</b> → S.M.A.R.T. error alert.</p> <p><b>"Read Errors"</b> → the hard drive has unrecoverable read errors.</p>
<b>Usage</b>	<p><b>RAID Disk.</b> This hard drive has been set to RAID.</p> <p><b>Free disk.</b> This hard drive is free for use.</p> <p><b>Dedicated Spare.</b> This hard drive has been set to the dedicated spare of the RG.</p> <p><b>Global Spare.</b> This hard drive has been set to a global spare of all RGs.</p>
<b>Vendor</b>	Hard drive vendor.
<b>Serial</b>	Hard drive serial number.
<b>Type</b>	<p>Hard drive type.</p> <p><b>"SATA"</b> → SATA disk.</p> <p><b>"SATA2"</b> → SATA II disk.</p> <p><b>"SAS"</b> → SAS disk.</p>
<b>Write cache</b>	Hard drive write cache is enabled or disabled. The default is enabled.
<b>Standby</b>	HDD auto spindown function to save power. The default value is disabled.
<b>Readahead</b>	Readahead function of HDD. Default value is enabled
<b>Command Queuing</b>	Command Queue function of HDD. Default value is enabled.

**PD operations description:**

<b>Set Free disk</b>	Make the selected hard drive to be free for use.
<b>Set Global spare</b>	Set the selected hard drive to global spare of all RGs.
<b>Set Dedicated spares</b>	Set hard drive to dedicated spare of selected RGs.
<b>Upgrade</b>	Upgrade hard drive firmware.
<b>Disk Scrub</b>	Scrub the hard drive.
<b>Turn on/off the indication LED</b>	Turn on the indication LED of the hard drive. Click again to turn off.
<b>More information</b>	Show hard drive detail information.

**5.4.2 RAID Group**

“**RAID group**” can view the status of each RAID group, create, and modify RAID groups. The following is an example to create a RG.

**Step 1:** Click “**Create**”, enter “**Name**”, choose “**RAID level**”, click “**Select PD**” to select PD, assign the RG’s “**Preferred owner**”. Then click “**OK**”. The “**Write Cache**” option is to enable or disable the hard drives’ write cache option. The “**Standby**” option is to enable or disable the hard drives’ auto spindown function, when this option is enabled and hard drives have no access after certain period of time, the hard drives automatically spin down. The “**Readahead**” option is to enable or disable the read ahead function. The “**Command queuing**” option is to enable or disable the hard drives’ command queue function.

**Create RAID group**

**Name :** RG-R0

**RAID level :** RAID 0

**RAID PD slot :** 1 2 3 4

**Preferred owner :** Auto

**Write Cache :** Enabled

**Standby :** Disabled

**Readahead :** Enabled

**Command queuing :** Enabled

OK Cancel

**Step 2:** Confirm page. Click **“OK”** if all setups are correct.

Show size unit as: (GB)

	Name	Total(GB)	Free(GB)	#PD	#VD	Status	Health	RAID	Current owner	Preferred owner
OP.	RG-R0	1862	1862	4	0	Online	Good	RAID 0	Controller 1	Controller 1
OP.	RG-R5	931	931	3	0	Online	Good	RAID 5	Controller 1	Controller 1

Migrate  
 Activate  
 Deactivate  
 Parity check  
 Delete  
 Set preferred owner  
 Set disk property  
 More information

There is a RAID 0 with 4 physical disks, named “RG-R0”. The second RAID group is a RAID 5 with 3 physical disks, named “RG-R5”

**Step 3:** Done. View **“RAID group”** page.

**RG column description:**

	The button includes the function which can be executed.
<b>Name</b>	RAID group name.
<b>Total(GB) (MB)</b>	Total capacity of this RAID group. This unit can be displayed in GB or MB.
<b>Free(GB) (MB)</b>	Free capacity of this RAID group. This unit can be displayed in GB or MB.
<b>#PD</b>	The number of physical disks in RAID group.

<b>#VD</b>	The number of virtual disks in RAID group.
<b>Status</b>	The status of RAID group. <b>"Online"</b> → the RAID group is online. <b>"Offline"</b> → the RAID group is offline. <b>"Rebuild"</b> → the RAID group is being rebuilt. <b>"Migrate"</b> → the RAID group is being migrated. <b>"Scrubbing"</b> → the RAID group is being scrubbed.
<b>Health</b>	The health of RAID group. <b>"Good"</b> → the RAID group is good. <b>"Failed"</b> → the hard drive is failed. <b>"Degraded"</b> → the RAID group is not completed. The reason could be lack of one disk or disk failure.
<b>RAID</b>	The RAID level of the RAID group.
<b>Current Owner</b>	The owner of the RAID group. The default owner is controller 1.
<b>Preferred owner</b>	The preferred owner of the RAID group. The default owner is controller 1.

#### RG operations description:

<b>Create</b>	Create a RAID group.
<b>Migrate</b>	Migrate a RAID group. Please refer to next chapter for more detail.
<b>Activate</b>	Activate a RAID group; it can be executed when RG status is offline. This is for online roaming purpose.
<b>Deactivate</b>	Deactivate a RAID group; it can be executed when RG status is online. This is for online roaming purpose.
<b>Parity check</b>	Regenerate parity for the RAID group. It supports RAID 3 / 5 / 6 / 30 / 50 / 60.
<b>Delete</b>	Delete a RAID group.
<b>Set preferred owner</b>	Set the RG ownership to the other controller.
<b>Set disk property</b>	Change the disk status of write cache and standby. <b>Write Cache</b> options: <b>"Enabled"</b> → Enable disk write cache. <b>"Disabled"</b> → Disable disk write cache.

	<p><b>Standby options:</b></p> <p>“Disabled” → Disable spindown.</p> <p>“30 sec / 1 min / 5 min / 30 min” → Enable hard drive auto spindown to save power in the period of time.</p> <p><b>Read ahead:</b></p> <p>“Enabled” → Enable disk read ahead. (Default)</p> <p>“Disabled” → Disable disk read ahead.</p> <p><b>Command queuing:</b></p> <p>“Enabled” → Enable disk command queue. (Default)</p> <p>“Disabled” → Disable disk command queue.</p>
<b>More information</b>	Show RAID group detail information.

### 5.4.3 Virtual Disk

“Virtual disk” can view the status of each Virtual disk, create, and modify virtual disks. The following is an example to create a VD.

**Step 1:** Click “Create”, enter “Name”, select RAID group from “RG name”, enter required “Capacity (GB)/(MB)”, change “Stripe height (KB)”, change “Block size (B)”, change “Read/Write” mode, set virtual disk “Priority”, select “Bg rate” (Background task priority), and change “Readahead” option if necessary. “Erase” option will wipe out old data in VD to prevent that OS recognizes the old partition. There are three options in “Erase”: None (default), erase first 1GB or full disk. Last, select “Type” mode for normal or clone usage. Then click “OK”.

The screenshot shows a 'Create' dialog box with the following fields and values:

- Name: VD-01
- RG name: RG-R0
- Capacity: 30 GB
- Stripe height (KB): 64
- Block size (B): 512
- Read/Write: Write-back cache (selected)
- Priority: High priority (selected)
- Bg rate: 4
- Readahead: Enabled
- AV-media mode: Disabled
- Erase: None
- Type: RAID (selected)

Buttons for 'OK' and 'Cancel' are visible at the bottom right.

**Step 2:** Confirm page. Click **“OK”** if all setups are correct.

Show size unit as: GB

	Name	Size(GB)	Write	Priority	Bg rate	Type	Clone	Schedule	Status	Health	R %	RAID	#LUN	Snapshot space(GB)	#Snapshot	RG
OP.	VD-01	30	WB	Hi	4	RAID	N/A	N/A	Online	Optimal		RAID 0	0	0/0	0	RG-R0
OP.	VD-02	20	WB	Hi	4	RAID	N/A	N/A	Initiating	Optimal	44	RAID 5	0	0/0	0	RG-R5

Extend

- Parity check
- Delete
- Set property
- Attach LUN
- Detach LUN
- List LUN
- Set clone
- Set snapshot space
- Cleanup snapshot
- Take snapshot
- Auto snapshot
- List snapshot
- More information

Create a VD named “VD-01”, from “RG-R0”. The second VD is named “VD-02”, it’s initializing.

**Step 3:** Done. View **“Virtual disk”** page.

**VD column description:**

	The button includes the functions which can be executed.
<b>Name</b>	Virtual disk name.
<b>Size (GB) (MB)</b>	Total capacity of the virtual disk. The unit can be displayed in GB or MB.
<b>Write</b>	The right of virtual disk: <ul style="list-style-type: none"> <li>• <b>“WT”</b> → <b>W</b>rite <b>T</b>hrough.</li> <li>• <b>“WB”</b> → <b>W</b>rite <b>B</b>ack.</li> <li>• <b>“RO”</b> → <b>R</b>ead <b>O</b>nly.</li> </ul>
<b>Priority</b>	The priority of virtual disk: <ul style="list-style-type: none"> <li>• <b>“HI”</b> → <b>H</b>igh priority.</li> <li>• <b>“MD”</b> → <b>M</b>iddle priority.</li> <li>• <b>“LO”</b> → <b>L</b>ow priority.</li> </ul>
<b>Bg rate</b>	Background task priority: <ul style="list-style-type: none"> <li>• <b>“4 / 3 / 2 / 1 / 0”</b> → Default value is 4. The higher number the background priority of a VD is, the more background I/O will be scheduled to execute.</li> </ul>
<b>Status</b>	The status of virtual disk: <ul style="list-style-type: none"> <li>• <b>“Online”</b> → The virtual disk is online.</li> <li>• <b>“Offline”</b> → The virtual disk is offline.</li> <li>• <b>“Initiating”</b> → The virtual disk is being initialized.</li> </ul>



	<ul style="list-style-type: none"> <li>• <b>“Rebuild”</b> → The virtual disk is being rebuilt.</li> <li>• <b>“Migrate”</b> → The virtual disk is being migrated.</li> <li>• <b>“Rollback”</b> → The virtual disk is being rolled back.</li> <li>• <b>“Parity checking”</b> → The virtual disk is being parity check.</li> </ul>
<b>Type</b>	<p>The type of virtual disk:</p> <ul style="list-style-type: none"> <li>• <b>“RAID”</b> → the virtual disk is normal.</li> <li>• <b>“BACKUP”</b> → the virtual disk is for clone usage.</li> </ul>
<b>Clone</b>	The target name of virtual disk.
<b>Schedule</b>	The clone schedule of virtual disk.
<b>Health</b>	<p>The health of virtual disk:</p> <ul style="list-style-type: none"> <li>• <b>“Optimal”</b> → the virtual disk is working well and there is no failed disk in the RG.</li> <li>• <b>“Degraded”</b> → At least one disk from the RG of the Virtual disk is failed or plugged out.</li> <li>• <b>“Failed”</b> → the RAID group disk of the VD has single or multiple failed disks than its RAID level can recover from data loss.</li> <li>• <b>“Partially optimal”</b> → the virtual disk has experienced recoverable read errors.</li> </ul>
<b>R %</b>	Ratio (%) of initializing or rebuilding.
<b>RAID</b>	RAID level.
<b>#LUN</b>	Number of LUN(s) that virtual disk is attached to.
<b>Snapshot (GB) (MB)</b>	The virtual disk size that is used for snapshot. The number means <b>“Used snapshot space” / “Total snapshot space”</b> . The unit can be displayed in GB or MB.
<b>#Snapshot</b>	Number of snapshot(s) that have been taken.
<b>RG name</b>	The RG name of the virtual disk

**VD operations description:**

<b>Create</b>	Create a virtual disk.
<b>Extend</b>	Extend a Virtual disk capacity.
<b>Parity check</b>	Execute parity check for the virtual disk. It supports RAID 3 / 5 / 6 / 30 / 50 / 60. Regenerate parity: <b>"Yes"</b> → Regenerate RAID parity and write. <b>"No"</b> → Execute parity check only and find mismatches. It will stop checking when mismatches count to 1 / 10 / 20 / ... / 100.
<b>Delete</b>	Delete a Virtual disk.
<b>Set property</b>	Change the VD name, Right, Priority and Bg rate. Right options: <b>"WT"</b> → Write Through. <b>"WB"</b> → Write Back. <b>"RO"</b> → Read Only. Priority options: <b>"HI"</b> → High priority. <b>"MD"</b> → Mid priority. <b>"LO"</b> → Low priority. Bg rate options: <b>"4 / 3 / 2 / 1 / 0"</b> → Default value is 4. The higher number the background priority of a VD has, the more background I/O will be scheduled to execute. Read ahead: <b>"Enabled"</b> → Enable disk read ahead. (Default) <b>"Disabled"</b> → Disable disk read ahead. AV-media mode: <ul style="list-style-type: none"> <li>• <b>"Enabled"</b> → Enable AV-media mode for optimizing video editing.</li> <li>• <b>"Disabled"</b> → Disable AV-media mode. (Default)</li> </ul> Type: <ul style="list-style-type: none"> <li>• <b>"RAID"</b> → the virtual disk is normal. (Default)</li> <li>• <b>"Backup"</b> → the virtual disk is for clone usage.</li> </ul>
<b>Attach LUN</b>	Attach to a LUN.
<b>Detach LUN</b>	Detach to a LUN.
<b>List LUN</b>	List attached LUN(s).

<b>Set clone</b>	Set the target virtual disk for clone.
<b>Clear clone</b>	Clear clone function.
<b>Start clone</b>	Start clone function.
<b>Stop clone</b>	Stop clone function.
<b>Schedule clone</b>	Set clone function by schedule.
<b>Set snapshot space</b>	Set snapshot space for executing snapshot. Please refer to next chapter for more detail.
<b>Cleanup snapshot</b>	Clean all snapshot VD related to the Virtual disk and release snapshot space.
<b>Take snapshot</b>	Take a snapshot on the Virtual disk.
<b>Auto snapshot</b>	Set auto snapshot on the Virtual disk.
<b>List snapshot</b>	List all snapshot VD related to the Virtual disk.
<b>More information</b>	Show Virtual disk detail information.

### 5.4.4 Snapshot

“**Snapshot**” can view the status of snapshot, create and modify snapshots. Please refer to next chapter for more detail about snapshot concept. The following is an example to take a snapshot.

**Step 1:** Create snapshot space. In “/ **Volume configuration / Virtual disk**”, move the mouse pointer to the gray button next to the VD number; click “**Set snapshot space**”.

**Step 2:** Set snapshot space. Then click “**OK**”. The snapshot space is created.

Show size unit as: (GB)

	Name	Size(GB)	Write	Priority	Bg rate	Type	Clone	Schedule	Status	Health	R %	RAID	#LUN	Snapshot space(GB)	#Snapshot	RG
OP	VD-01	30	WB	HI	4	RAID	N/A	N/A	Online	Optimal		RAID 0	0	1/15	0	RG-R0
OP	VD-02	20	WB	HI	4	RAID	N/A	N/A	Online	Optimal		RAID 5	0	0/0	0	RG-R5

“VD-01” snapshot space has been created, snapshot space is 15GB, and used 1GB for saving snapshot index.

**Step 3:** Take a snapshot. In “/ **Volume configuration / Snapshot**”, click “**Take snapshot**”. It will link to next page. Enter a snapshot name.

**Step 4:** Expose the snapshot VD. Check the gray button next to the Snapshot VD number; click **“Expose”**. Enter a capacity for snapshot VD. If size is zero, the exported snapshot VD will be read only. Otherwise, the exported snapshot VD can be read / written, and the size will be the maximum capacity to read/write.

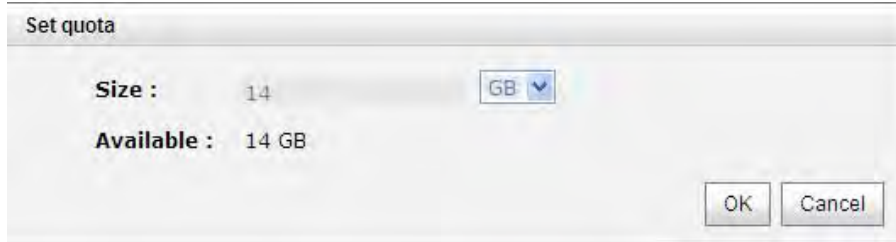

The 'Set quota' dialog box shows a 'Size' field set to 14 with a unit dropdown menu currently set to 'GB'. Below it, the 'Available' field is set to 14 GB. At the bottom right, there are 'OK' and 'Cancel' buttons.

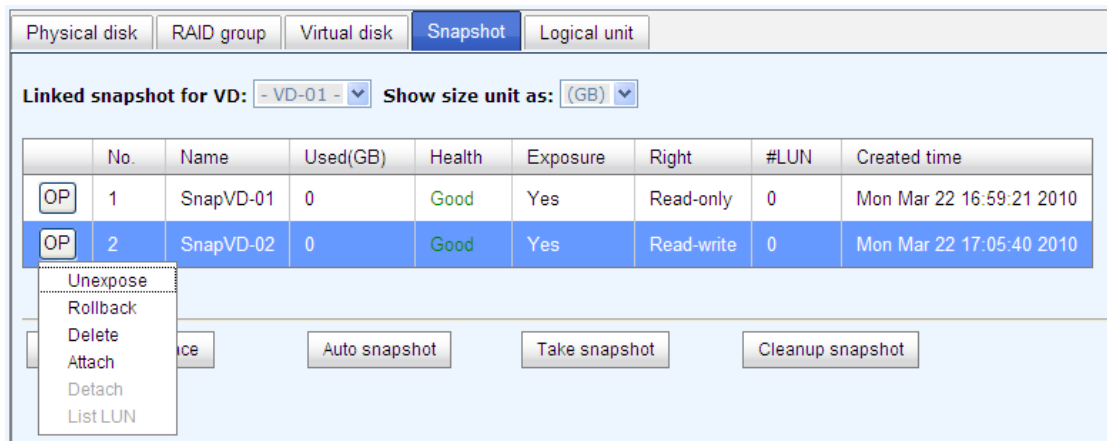

The screenshot shows the 'Snapshot' tab in a management console. It features a table of snapshots for 'VD-01' and a context menu for the selected 'SnapVD-02'.

	No.	Name	Used(GB)	Health	Exposure	Right	#LUN	Created time
OP	1	SnapVD-01	0	Good	Yes	Read-only	0	Mon Mar 22 16:59:21 2010
OP	2	SnapVD-02	0	Good	Yes	Read-write	0	Mon Mar 22 17:05:40 2010

The context menu for 'SnapVD-02' includes: Unexpose, Rollback, Delete, Attach, Detach, and List LUN. Below the table are buttons for 'Auto snapshot', 'Take snapshot', and 'Cleanup snapshot'.

This is the list of snapshots in “VD-01”. There are two snapshots in “VD-01”. Snapshot VD “SnapVD-01” is exported as read only, “SnapVD-02” is exported as read/write.

**Step 5:** Attach a LUN for snapshot VD. Please refer to the next section for attaching a LUN.

**Step 6:** Done. Snapshot VD can be used.

#### Snapshot column description:

	The button includes the functions which can be executed.
<b>Name</b>	Snapshot VD name.
<b>Used (GB) (MB)</b>	The amount of snapshot space that has been used. The unit can be displayed in GB or MB.
<b>Status</b>	The status of snapshot: <ul style="list-style-type: none"> <li>• <b>“N/A”</b> → The snapshot is normal.</li> <li>• <b>“Replicated”</b> → The snapshot is for clone or QReplica usage.</li> <li>• <b>“Abort”</b> → The snapshot is over space and abort.</li> </ul>

<b>Health</b>	The health of snapshot: <ul style="list-style-type: none"> <li>• <b>“Good”</b> → The snapshot is good.</li> <li>• <b>“Failed”</b> → The snapshot fails.</li> </ul>
<b>Exposure</b>	Snapshot VD is exposed or not.
<b>Right</b>	The right of snapshot: <ul style="list-style-type: none"> <li>• <b>“Read-write”</b> → The snapshot VD can be read / write.</li> <li>• <b>“Read-only”</b> → The snapshot VD is read only.</li> </ul>
<b>#LUN</b>	Number of LUN(s) that snapshot VD is attached.
<b>Created time</b>	Snapshot VD created time.

#### Snapshot operation description:

<b>Expose/ Unexpose</b>	Expose / unexpose the snapshot VD.
<b>Rollback</b>	Rollback the snapshot VD.
<b>Delete</b>	Delete the snapshot VD.
<b>Attach</b>	Attach a LUN.
<b>Detach</b>	Detach a LUN.
<b>List LUN</b>	List attached LUN(s).

## 5.4.5 Logical Unit

“**Logical unit**” can view, create, and modify the status of attached logical unit number(s) of each VD.

User can attach LUN by clicking the “**Attach**”. “**Host**” must enter with an iSCSI node name for access control, or fill-in wildcard “\*”, which means every host can access the volume. Choose LUN number and permission, and then click “**OK**”.

	Host	Target	LUN	Permission	VD name	#Session
<input type="button" value="OP"/>	*	0	0	Read-write	VD-01	2
<input type="button" value="OP"/>	iqn.1991-05.com.microsoft:sdfs-56745d1467	0	1	Read-write	VD-02	2

VD-01 is attached to LUN 0 and every host can access. VD-02 is attached to LUN 1 and only initiator node which is named “iqn.1991-05.com.microsoft:win-r6qrvqjd5m7” can access.

### LUN operations description:

<b>Attach</b>	Attach a logical unit number to a Virtual disk.
<b>Detach</b>	Detach a logical unit number from a Virtual disk.

The matching rules of access control are inspected from top to bottom in sequence. For example: there are 2 rules for the same VD, one is “\*”, LUN 0; and the other is “iqn.host1”, LUN 1. The other host “iqn.host2” can login successfully because it matches rule 1.

The access will be denied when there is no matching rule.

## 5.4.6 Example

The following is an example for creating volumes. Example 1 is to create two VDs and set a global spare disk.

- **Example 1**

Example 1 is to create two VDs in one RG, each VD uses global cache volume. Global cache volume is created after system boots up automatically. So, no action is needed to set CV. Then set a global spare disk. Eventually, delete all of them.

**Step 1:** Create RG (RAID group).

To create the RAID group, please follow these steps:

1. Select “/ **Volume configuration / RAID group**”.
2. Click “**Create**”.
3. Input an RG Name, choose a RAID level from the list, click “**Select PD**” to choose the RAID PD slot(s), then click “**OK**”.

4. Check the outcome. Click “**OK**” if all setups are correct.



- Done. An RG has been created.

The screenshot shows the RAID group configuration interface. At the top, there are tabs for "Physical disk", "RAID group", "Virtual disk", "Snapshot", and "Logical unit". Below the tabs, there is a "Show size unit as:" dropdown menu set to "(GB)". A table displays the RAID group details:

	Name	Total(GB)	Free(GB)	#PD	#VD	Status	Health	RAID	Current owner	Preferred owner
OP:	RG-R5	152	152	3	0	Online	Good	RAID 5	Controller 1	Controller 1

At the bottom of the interface, there is a "Create" button.

A RAID 5 RG named "RG-R5" with 3 physical disks is created. The total size is 152GB. Because there is no related VD, free size still remains 152GB.

### Step 2: Create VD (Virtual disk).

To create a data user volume, please follow these steps.

- Select **"/ Volume configuration / Virtual disk"**.
- Click **"Create"**.
- Input a VD name, choose the RG when VD will be created, enter the VD capacity, select the stripe height, block size, read/write mode, set priority, modify Bg rate if necessary, and finally click **"OK"**.

The screenshot shows the "Create" dialog box for a virtual disk. The fields are as follows:

- Name :** VD-R5-1
- RG name :** RG-R5
- Capacity :** 50 GB
- Stripe height (KB) :** 64
- Block size (B) :** 512
- Read/Write :**  Write-through cache  Write-back cache
- Priority :**  High priority  Middle priority  Low priority
- Bg rate :** 4
- Readahead :** Enabled
- AV-media mode :** Disabled
- Erase :** None
- Type :** RAID

At the bottom right, there are "OK" and "Cancel" buttons.

- Done. A VD has been created.

5. Repeat steps 1 to 4 to create another VD.

Show size unit as: (GB)

	Name	Size(GB)	Write	Priority	Bg rate	Type	Clone	Schedule	Status	Health	R %	RAID	#LUN	Snapshot space(GB)	#Snapshot	RG
OP	VD-R5-1	50	WB	HI	4	RAID	N/A	N/A	Initiating	Optimal	9	RAID 5	0	0/0	0	RG-R5
OP	VD-R5-2	64	WB	HI	4	RAID	N/A	N/A	Initiating	Optimal	0	RAID 5	0	0/0	0	RG-R5

Two VDs, "VD-R5-1" and "VD-R5-2", were created from RG "RG-R5". The size of "VD-R5-1" is 50GB, and the size of "VD-R5-2" is 64GB. There is no LUN attached.

**Step 3:** Attach LUN to VD.

There are 2 methods to attach LUN to VD.

1. In **"/ Volume configuration / Virtual disk"**, move the mouse pointer to the gray button next to the VD number; click **"Attach LUN"**.
2. In **"/ Volume configuration / Logical unit"**, click **"Attach"**.

The steps are as follows:

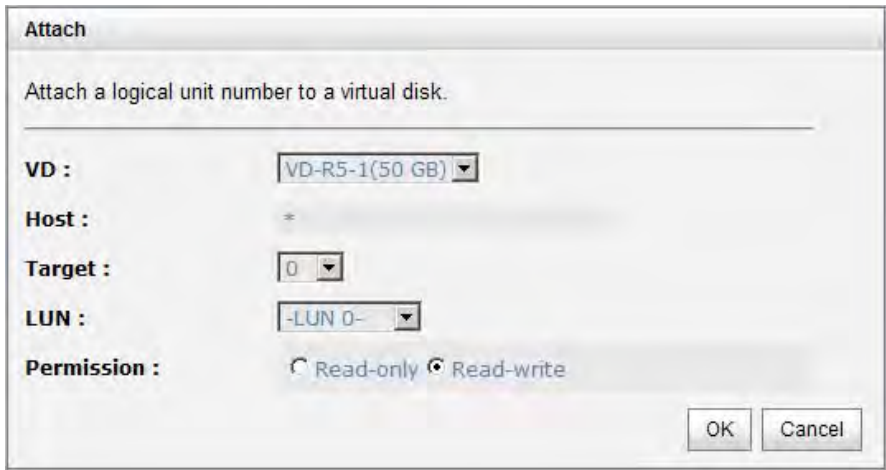

1. Select a VD.
2. Input **"Host"** name, which is a inq name for access control, or fill-in wildcard **"\*"**, which means every host can access to this volume. Choose LUN and permission, and then click **"OK"**.
3. Done.

	Physical disk	RAID group	Virtual disk	Snapshot	Logical unit		
	Host		Target	LUN	Permission	VD name	#Session
OP	*		0	0	Read-write	VD-R5-1	2
OP	iqn.1991-05.com.microsoft:sdfs-56745d1467		0	1	Read-write	VD-R5-2	2

Attach

VD-R5-1 is attached to LUN 0. VD-R5-2 is attached LUN 1.



**NOTE: The matching rules of access control are from top to bottom in sequence.**

**Step 4:** Set global spare disk.

To set global spare disks, please follow the procedures.

1. Select “/ **Volume configuration / Physical disk**”.
2. Check the gray button next to the PD slot; click “**Set Global spare**”.
3. “**Global spare**” icon is shown in “**Usage**” column.

Slot	Size(MB)	RG	Status	Health	Usage	Vendor	Serial	Type	Write cache	Standby	Readahead	Command queuing
OP 1	285912	RG-R5	Online	Good	RAID disk	WDC	WD-WXLY08094604	SATA2	Enabled	Disabled	Enabled	Enabled
OP 2	238219	RG-R5	Online	Good	RAID disk	Seagate	5QE3MPBG	SATA	Enabled	Disabled	Enabled	Enabled
OP 3	78277	RG-R5	Online	Good	RAID disk	Hitachi	PFDB30S2US713M	SATA2	Enabled	Disabled	Enabled	Enabled
OP 4	238219		Online	Good	Global spare	Seagate	9SF0M2FT	SATA2	Enabled	Disabled	Enabled	Disabled
			Online	Good	Free disk	Hitachi	VDK41BT4CBWWUE	SATA2	Enabled	Disabled	Enabled	Disabled
			Online	Good	Free disk	WDC	WD-WXLY08093882	SATA2	Enabled	Disabled	Enabled	Disabled
			Online	Good	Free disk	Hitachi	PFDB30S4R6HVKM	SATA2	Enabled	Disabled	Enabled	Disabled
			Online	Good	Free disk	Seagate	9SF0PBQV	SATA2	Enabled	Disabled	Enabled	Disabled

Slot 4 is set as global spare disk (GS).

**Step 5:** Done. LUNs can be used as disks.

To delete VDs, RG, please follow the steps listed below.

**Step 6:** Detach LUN from VD.

In “/ **Volume configuration / Logical unit**”,

Host	Target	LUN	Permission	VD name	#Session
OP *	0	0	Read-write	VD-R5-1	2
OP iqn.1991-05.com.microsoft.sdfs-56745d1467	0	1	Read-write	VD-R5-2	2

1. Check the gray button next to the LUN; click “**Detach**”. There will pop up a confirmation page.
2. Choose “OK”.
3. Done.

**Step 7:** Delete VD (Virtual disk).

To delete the Virtual disk, please follow the procedures:

1. Select “/ **Volume configuration / Virtual disk**”.
2. Check the gray button next to the VD number; click “**Delete**”. There will pop up a confirmation page, click “**OK**”.

3. Done. Then, the VD(s) are deleted.



**NOTE: When deleting VD, the attached LUN(s) related to this VD will be detached automatically.**

**Step 8:** Delete RG (RAID group).

To delete the RAID group, please follow the procedures:

1. Select **"/ Volume configuration / RAID group"**.
2. Select a RG which is no VD related on this RG, otherwise the VD(s) on this RG must be deleted first.
3. Check the gray button next to the RG number click **"Delete"**.
4. There will pop up a confirmation page, click **"OK"**.
5. Done. The RG has been deleted.



**NOTE: The action of deleting one RG will succeed only when all of the related VD(s) are deleted in this RG. Otherwise, it will have an error when deleting this RG.**

**Step 9:** Free global spare disk.

To free global spare disks, please follow the procedures.

1. Select **"/ Volume configuration / Physical disk"**.
2. Check the gray button next to the PD slot; click **"Set Free disk"**.

**Step 10:** Done, all volumes have been deleted.

## 5.5 Enclosure Management

“**Enclosure management**” allows managing enclosure information including “**SES configuration**”, “**Hardware monitor**”, “**S.M.A.R.T.**” and “**UPS**”. For the enclosure management, there are many sensors for different purposes, such as temperature sensors, voltage sensors, hard disks, fan sensors, power sensors, and LED status. Due to the different hardware characteristics among these sensors, they have different polling intervals. Below are the details of polling time intervals:

1. Temperature sensors: 1 minute.
2. Voltage sensors: 1 minute.
3. Hard disk sensors: 10 minutes.
4. Fan sensors: 10 seconds . When there are 3 errors consecutively, controller sends ERROR event log.
5. Power sensors: 10 seconds, when there are 3 errors consecutively, controller sends ERROR event log.
6. LED status: 10 seconds.

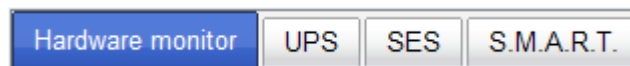

### 5.5.1 Hardware Monitor

“**Hardware monitor**” can view the information of current voltages and temperatures.

Hardware monitor    UPS    SES    S.M.A.R.T.

Show information for: - Local -

**Controller 1**

Type	Item	Value	Status
Voltage	Onboard +1.2V	+1.20 V (min = +1.08 V, max = +1.32 V)	OK
Voltage	Onboard +3.3V	+3.36 V (min = +3.04 V, max = +3.56 V)	OK
Voltage	Onboard +5V	+5.14 V (min = +4.60 V, max = +5.40 V)	OK
Voltage	Onboard +12V	+12.35 V (min = +11.04 V, max = +12.96 V)	OK
Voltage	Onboard +1.8V	+1.82 V (min = +1.62 V, max = +1.98 V)	OK
Temperature	Core Processor	+44.0 (C) (hyst = +0.0 (C), high = +80.0 (C))	OK
Temperature	iSCSI NIC	+30.0 (C) (hyst = +0.0 (C), high = +65.0 (C))	OK
Temperature	SAS Controller	+35.0 (C) (hyst = +0.0 (C), high = +65.0 (C))	OK
Temperature	SAS Expander	+32.0 (C) (hyst = +0.0 (C), high = +65.0 (C))	OK

**Controller 2**

Type	Item	Value	Status
Voltage	Onboard +1.2V	+1.22 V (min = +1.08 V, max = +1.32 V)	OK
Voltage	Onboard +3.3V	+3.41 V (min = +3.04 V, max = +3.56 V)	OK
Voltage	Onboard +5V	+5.19 V (min = +4.60 V, max = +5.40 V)	OK
Voltage	Onboard +12V	+12.38 V (min = +11.04 V, max = +12.96 V)	OK
Voltage	Onboard +1.8V	+1.84 V (min = +1.62 V, max = +1.98 V)	OK
Temperature	Core Processor	+39.5 (C) (hyst = +0.0 (C), high = +80.0 (C))	OK
Temperature	iSCSI NIC	+29.5 (C) (hyst = +0.0 (C), high = +65.0 (C))	OK
Temperature	SAS Controller	+36.0 (C) (hyst = +0.0 (C), high = +65.0 (C))	OK
Temperature	SAS Expander	+32.0 (C) (hyst = +0.0 (C), high = +65.0 (C))	OK

**BPL**

<< first < prev 1 2 next > last >>

Type	Item	Value	Status
Voltage	PSU +5V	+5.05 V (min = +4.60 V, max = +5.40 V)	OK
Voltage	PSU +12V	+12.35 V (min = +11.04 V, max = +12.96 V)	OK
Voltage	PSU +3.3V	+3.34 V (min = +3.04 V, max = +3.56 V)	OK
Temperature	Location 01	+26.0 (C) (hyst = +0.0 (C), high = +60.0 (C))	OK
Temperature	Location 02	+28.5 (C) (hyst = +0.0 (C), high = +60.0 (C))	OK
Temperature	Location 03	+27.5 (C) (hyst = +0.0 (C), high = +60.0 (C))	OK
Temperature	Location 04	+27.0 (C) (hyst = +0.0 (C), high = +60.0 (C))	OK
Temperature	Location 05	+26.0 (C) (hyst = +0.0 (C), high = +60.0 (C))	OK
Temperature	Location 06	+26.5 (C) (hyst = +0.0 (C), high = +60.0 (C))	OK
Temperature	Location 07	+27.0 (C) (hyst = +0.0 (C), high = +60.0 (C))	OK
Temperature	Location 08	+27.0 (C) (hyst = +0.0 (C), high = +60.0 (C))	OK
Temperature	Location 09	+24.0 (C) (hyst = +0.0 (C), high = +60.0 (C))	OK
Temperature	Location 10	+24.5 (C) (hyst = +0.0 (C), high = +60.0 (C))	OK
Temperature	Location 11	+25.0 (C) (hyst = +0.0 (C), high = +60.0 (C))	OK
Temperature	Location 12	+25.0 (C) (hyst = +0.0 (C), high = +60.0 (C))	OK
Temperature	Location 13	+24.0 (C) (hyst = +0.0 (C), high = +60.0 (C))	OK
Temperature	Location 14	+24.0 (C) (hyst = +0.0 (C), high = +60.0 (C))	OK
Temperature	Location 15	+24.0 (C) (hyst = +0.0 (C), high = +60.0 (C))	OK
Temperature	Location 16	+24.0 (C) (hyst = +0.0 (C), high = +60.0 (C))	OK
Power Supply	PSU1	N/A	OK

<< first < prev 1 2 next > last >>

**Auto shutdown :**

If 'Auto shutdown' has been checked, the system will shutdown automatically when voltage or temperature is out of the normal range.

If **“Auto shutdown”** has been checked, the system will shutdown automatically when voltage or temperature is out of the normal range. For better data protection, please check **“Auto Shutdown”**.

For better protection and avoiding single short period of high temperature triggering auto shutdown, the RAID controller evaluates multiple conditions for triggering auto shutdown. Below are the details of when the Auto shutdown will be triggered.

1. There are several sensors placed on systems for temperature checking. System will check each sensor for every 30 seconds. When one of these sensor is over high temperature threshold for continuous 3 minutes, auto shutdown will be triggered immediately.
2. The core processor temperature limit is 80°C. The iSCSI NIC temperature limit is 65°C. The SAS expander and SAS controller temperature limit is 65°C.
3. If the high temperature situation doesn't last for 3 minutes, system will not trigger auto shutdown.

## 5.5.2 UPS

**“UPS”** is used to set up UPS (**U**ninterruptible **P**ower **S**upply).

Hardware monitor | **UPS** | SES | S.M.A.R.T.

**The system supports and communicates with smart-UPS of APC.**  
Choose Smart-UPS for APC, None for other vendors or no UPS.

**UPS type :**

**Shutdown battery level (%) :**

**Shutdown delay (s) :**

**Shutdown UPS :**

**Status :**

**Battery level :**

Currently, the system only supports and communicates with APC (American Power Conversion Corp.) smart UPS. Please review the details from the website: <http://www.apc.com/>.

First, connect the system and APC UPS via RS-232 for communication. Then set up the shutdown values (shutdown battery level %) when power is failed. UPS in other companies can work well, but they have no such communication feature with the system.

Hardware monitor	<b>UPS</b>	SES	S.M.A.R.T.
<p><b>The system supports and communicates with smart-UPS of APC.</b>                  Choose Smart-UPS for APC, None for other vendors or no UPS.</p>			
UPS type :	Smart-UPS ▾		
Shutdown battery level (%) :	5 ▾		
Shutdown delay (s) :	30 ▾		
Shutdown UPS :	ON ▾		
Status :	Running		
Battery level :	 100%		
<input type="button" value="Confirm"/>			

<b>UPS Type</b>	Select UPS Type. Choose Smart-UPS for APC, None for other vendors or no UPS.
<b>Shutdown Battery Level (%)</b>	When below the setting level, system will shutdown. Setting level to "0" will disable UPS.
<b>Shutdown Delay (s)</b>	If power failure occurred, and system cannot return to value setting status, the system will shutdown. Setting delay to "0" will disable the function.
<b>Shutdown UPS</b>	Select ON, when power is gone, UPS will shut down by itself after the system shutdown successfully. After power comes back, UPS will start working and notify system to boot up. OFF will not.
<b>Status</b>	The status of UPS. "Detecting..." "Running" "Unable to detect UPS" "Communication lost" "UPS reboot in progress" "UPS shutdown in progress" "Batteries failed. Please change them NOW!"
<b>Battery Level (%)</b>	Current percentage of battery level.



### 5.5.3 SES

**SES** represents **SCSI Enclosure Services**, one of the enclosure management standards. "**SES configuration**" can enable or disable the management of SES.

Host	Target	LUN
*	0	0

Enable SES in LUN 0, and can be accessed from every host

The SES client software is available at the following web site:

SANtools: <http://www.santools.com/>

### 5.5.4 Hard Drive S.M.A.R.T. Support

**S.M.A.R.T.** (Self-Monitoring Analysis and Reporting Technology) is a diagnostic tool for hard drives to deliver warning of drive failures in advance. S.M.A.R.T. provides users chances to take actions before possible drive failure.

S.M.A.R.T. measures many attributes of the hard drive all the time and inspects the properties of hard drives which are close to be out of tolerance. The advanced notice of possible hard drive failure can allow users to back up hard drive or replace the hard drive. This is much better than hard drive crash when it is writing data or rebuilding a failed hard drive.

"**S.M.A.R.T.**" can display S.M.A.R.T. information of hard drives. The number is the current value; the number in parenthesis is the threshold value. The threshold values of hard drive vendors are different; please refer to vendors' specification for details.

S.M.A.R.T. only supports SATA drive. SAS drive does not have. It will show N/A in this web page.

Hardware monitor	UPS	SES	<b>S.M.A.R.T.</b>
------------------	-----	-----	-------------------

**Self-Monitoring Analysis and Reporting Technology(S.M.A.R.T).**  
 A diagnostic tool for hard drives to deliver warning of drive failures in advance. S.M.A.R.T. provides users chances to take actions before possible drive failure.

Show information for:

Slot	HDD type	Read error	Spin up	Reallocated sector	Seek error	Spin up	Calibration	Temperature
1	SAS	N/A	N/A	N/A	N/A	N/A	N/A	38
2	SAS	N/A	N/A	N/A	N/A	N/A	N/A	39
3	SAS	N/A	N/A	N/A	N/A	N/A	N/A	38
4	SAS	N/A	N/A	N/A	N/A	N/A	N/A	39
5	SAS	N/A	N/A	N/A	N/A	N/A	N/A	38
6	SAS	N/A	N/A	N/A	N/A	N/A	N/A	38
7	SAS	N/A	N/A	N/A	N/A	N/A	N/A	35
8	SAS	N/A	N/A	N/A	N/A	N/A	N/A	33

Hardware monitor	UPS	SES	<b>S.M.A.R.T.</b>
------------------	-----	-----	-------------------

**Self-Monitoring Analysis and Reporting Technology(S.M.A.R.T).**  
 A diagnostic tool for hard drives to deliver warning of drive failures in advance. S.M.A.R.T. provides users chances to take actions before possible drive failure.

Show information for:

Slot	HDD type	Read error	Spin up	Reallocated sector	Seek error	Spin up	Calibration	Temperature
1	SATA	100(16)	101(24)	100(5)	100(67)	100(60)	N/A	28
2	SATA	100(16)	104(24)	100(5)	100(67)	100(60)	N/A	28
3	SATA	100(16)	98(24)	100(5)	100(67)	100(60)	N/A	27
4	SATA	100(16)	97(24)	100(5)	100(67)	100(60)	N/A	27
5	SATA	100(16)	104(24)	100(5)	100(67)	100(60)	N/A	28
6	SATA	100(16)	100(24)	100(5)	100(67)	100(60)	N/A	27
7	SATA	100(16)	99(24)	100(5)	100(67)	100(60)	N/A	27
8	SATA	100(16)	103(24)	100(5)	100(67)	100(60)	N/A	26

## 5.6 System Maintenance

“**Maintenance**” allows the operations of system functions which include “**System information**” to show the system version and details, “**Event log**” to view system event logs to record critical events, “**Upgrade**” to the latest firmware, “**Firmware synchronization**” to synchronized firmware versions on both controllers, “**Reset to factory default**” to reset all controller configuration values to factory settings, “**Import and export**” to import and export all controller configuration to a file, and “**Reboot and shutdown**” to reboot or shutdown the system.

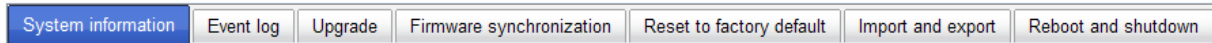

### 5.6.1 System Information

“**System information**” can display system information, including CPU type, installed system memory, firmware version, serial numbers of dual controllers, backplane ID, and system status.

Item	Information
CPU type	XSC3-IOP8134x Family rev 9 (v5l)
System memory	ECC Unbuffered DDR-II 2048MB
Firmware version	EP-3164D-GAS3 2.0.0p1 (build 201011181200)
Serial number	001378B502F0 (Controller 1 : 5001378003905F98 , Controller 2 : 50013780039070D8 )
Backplane ID	R6R
Status	Normal

#### Status description:

<b>Normal</b>	Dual controllers are in normal stage.
<b>Degraded</b>	One controller fails or has been plugged out..
<b>Lockdown</b>	The firmware of two controllers is different or the size of memory of two controllers is different.
<b>Single</b>	Single controller mode.

## 5.6.2 Event Log

“Event log” can view the event messages. Check the checkbox of INFO, WARNING, and ERROR to choose the level of event log display. Click “Download” button to save the whole event log as a text file with file name “log-ModelName-SerialNumber-Date-Time.txt”. Click “Clear” button to clear all event logs. Click “Mute” button to stop alarm if system alerts.

Select event level of displayed event log

INFO
  WARNING
  ERROR

<< first < prev 1 2 3 4 5 6 7 8 next > last >>

Type	Time	Content
INFO	Tue, 23 Mar 2010 10:38:41	[CTR1] admin login from 192.168.10.47 via Web UI
INFO	Tue, 23 Mar 2010 09:02:08	[CTR1] admin login from 192.168.10.154 via Web UI
INFO	Mon, 22 Mar 2010 18:08:14	[CTR1] admin login from 192.168.10.47 via Web UI
INFO	Mon, 22 Mar 2010 17:17:49	[CTR1] Assign PD 4 to Global Spare Disks.
INFO	Mon, 22 Mar 2010 17:17:48	[CTR2] Assign PD 4 to Global Spare Disks.
INFO	Mon, 22 Mar 2010 17:13:51	[CTR1] RG RG-R5 has been created.
INFO	Mon, 22 Mar 2010 17:13:10	[CTR1] RG RG-R5 has been deleted.
INFO	Mon, 22 Mar 2010 17:13:06	[CTR1] VD VD-02 has been deleted.
INFO	Mon, 22 Mar 2010 17:12:15	[CTR1] RG RG-R0 has been deleted.
INFO	Mon, 22 Mar 2010 17:12:09	[CTR1] VD SnapVD-02 has been deleted.
INFO	Mon, 22 Mar 2010 17:12:09	[CTR1] VD SnapVD-01 has been deleted.
INFO	Mon, 22 Mar 2010 17:12:09	[CTR1] VD VD-01 has been deleted.
INFO	Mon, 22 Mar 2010 17:06:44	[CTR1] VD SnapVD-01 has been created.
INFO	Mon, 22 Mar 2010 17:06:39	[CTR1] VD SnapVD-01 has been deleted.
INFO	Mon, 22 Mar 2010 17:06:12	[CTR1] VD SnapVD-01 has been created.
INFO	Mon, 22 Mar 2010 17:06:02	[CTR1] VD SnapVD-02 has been created.
INFO	Mon, 22 Mar 2010 17:05:54	[CTR1] VD SnapVD-01 has been deleted.
INFO	Mon, 22 Mar 2010 17:05:40	[CTR1] A snapshot on VD VD-01 has been taken.
INFO	Mon, 22 Mar 2010 17:05:12	[CTR1] The snapshot space of VD VD-02 is cleared
INFO	Mon, 22 Mar 2010 17:05:12	[CTR1] VD SnapVD-02 has been deleted.

<< first < prev 1 2 3 4 5 6 7 8 next > last >>

The event log is displayed in reverse order which means the latest event log is on the first page. The event logs are actually saved in the first four hard drives; each hard drive has one copy of event log. For one controller, there are four copies of event logs to make sure users can check event log any time when there is/are failed disk(s).



**NOTE:** Please plug-in any of the first four hard drives, then event logs can be saved and displayed in next system boot up. Otherwise, the event logs would disappear.

### 5.6.3 Upgrade

“Upgrade” can upgrade firmware. Please prepare new firmware file named “xxxx.bin” in local hard drive, then click “Browse” to select the file. Click “Confirm”, it will pop up a message “Upgrade system now? If you want to downgrade to the previous FW later (not recommend), please export your system configuration in advance”, click “Cancel” to export system configuration in advance, then click “OK” to start to upgrade firmware.

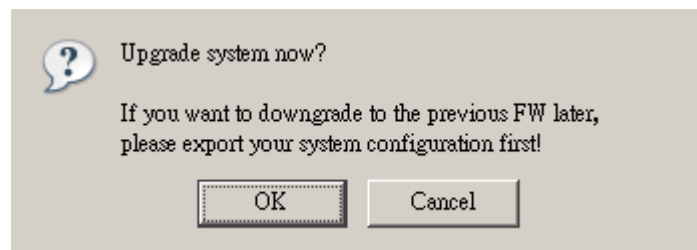
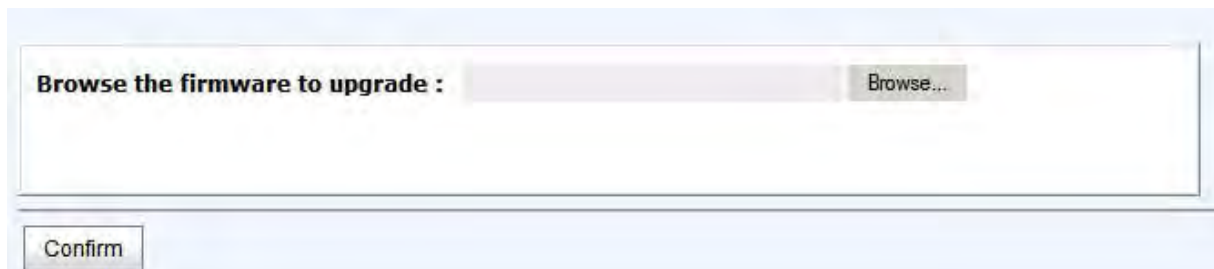

When upgrading, there is a progress bar running. After finished upgrading, the system must reboot manually to make the new firmware took effect.



**NOTE: Please contact your vendor for the latest firmware.**

## 5.6.4 Firmware Synchronization

“**Firmware synchronization**” can synchronize the firmware version when controller 1 and controller 2’s firmware are different. It will upgrade the firmware of slave controller to master ones no matter what the firmware version of slave controller is newer or older than master. In normal status, the firmware versions in controller 1 and 2 are the same as below figure.

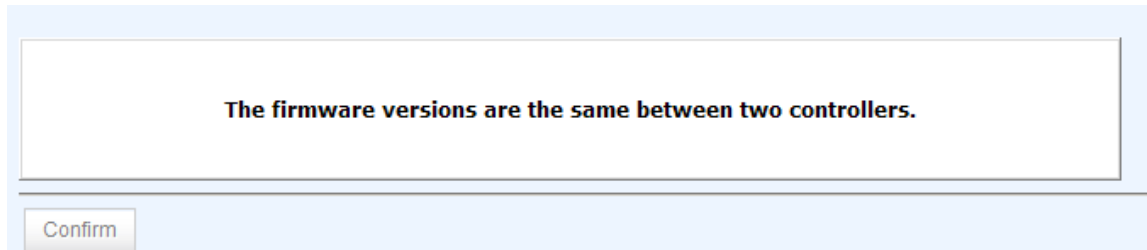

## 5.6.5 Reset to Factory Default

“**Reset to factory default**” allows user to reset controller to factory default setting.

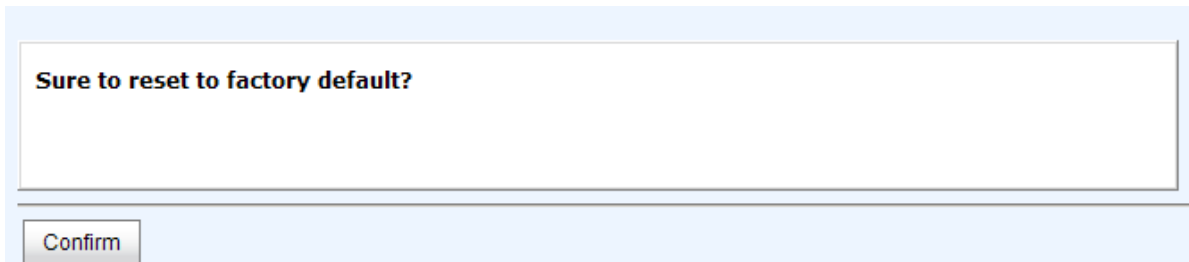

Reset to default value, the password is: **00000000**, and IP address to default DHCP.

### 5.6.6 Import and Export

“**Import and export**” allows user to save system configuration values: export, and apply all configuration: import. For the volume configuration setting, the values are available in export and not available in import which can avoid conflict / data-deleting between two controllers which mean if one system already has valuable volumes in the disks and user may forget and overwrite it. Use import could return to original configuration. If the volume setting was also imported, user’s current volumes will be overwritten with different configuration.

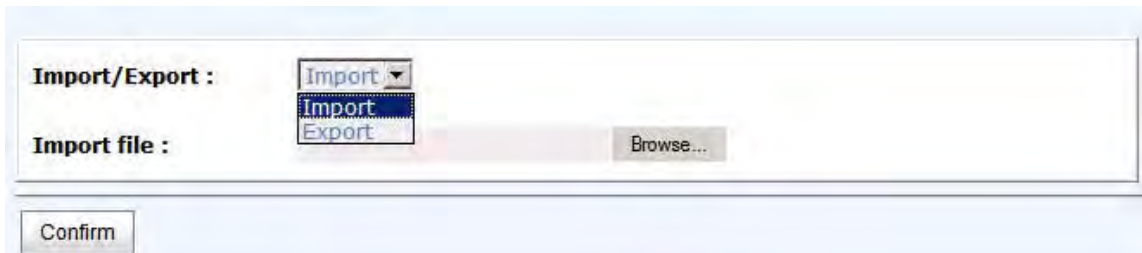

1. **Import:** Import all system configurations excluding volume configuration.
2. **Export:** Export all configurations to a file.



**WARNING:** “**Import**” will import all system configurations excluding volume configuration; the current configurations will be replaced.

### 5.6.7 Reboot and Shutdown

“**Reboot and shutdown**” displays “**Reboot**” and “**Shutdown**” buttons. Before power off, it’s better to execute “**Shutdown**” to flush the data from cache to physical disks. The step is necessary for data protection.



## 5.7 Home/Logout/Mute

In the right-upper corner of web UI, there are 3 individual icons, **“Home”**, **“Logout”**, and **“Mute”**.



### 5.7.1 Home

Click **“Home”** to return to home page

### 5.7.2 Logout

For security reason, please use **“Logout”** to exit the web UI. To re-login the system, please enter username and password again.

### 5.7.3 Mute

Click **“Mute”** to stop the alarm when error occurs.



## Chapter 6 Advanced Operations

### 6.1 Volume Rebuild

If one physical disk from a RG, which is set to a protected RAID level (e.g. RAID 3, RAID 5, or RAID 6), failed or has been unplugged/removed, the status of RG is changed to degraded mode. The system will search/detect spare disk to rebuild the degraded RG to become normal/complete. It will detect dedicated spare disk as rebuild disk first, then global spare disk.

The iSCSI RAID subsystem supports Auto-Rebuild. The following is the scenario:

Take RAID 6 for example:

1. When there is no global spare disk or dedicated spare disk in the system, controller will be in degraded mode and wait until (A) there is one disk assigned as spare disk, or (B) the failed disk is removed and replaced with new clean disk, then the Auto-Rebuild starts. The new disk will be a spare disk to the original RG automatically.

If the new added disk is not clean (with other RG information), it would be marked as RS (reserved) and the system will not start "auto-rebuild".

If this disk is not belonging to any existing RG, it would be FR (Free) disk and the system will start Auto-Rebuild.

If user only removes the failed disk and plugs the same failed disk in the same slot again, the auto-rebuild will start running. But rebuilding in the same failed disk may impact customer data if the status of disk is unstable. It is recommended for users not to rebuild in the failed disk for better data protection.

2. When there is enough global spare disk(s) or dedicated spare disk(s) for the degraded array, the system starts Auto-Rebuild immediately. And in RAID 6, if another disk failure occurs during rebuilding, the system will start the above Auto-Rebuild process as well. Auto-Rebuild feature only works when the status of RG is "**Online**". It will not work at "**Offline**" status. Thus, it will not conflict with the "**Roaming**".
3. In degraded mode, the status of RG is "**Degraded**". When rebuilding, the status of RG/VD will be "**Rebuild**", the column "**R%**" in VD will display the ratio in percentage. After completing the rebuilding process, the status will become "**Online**". RG will become complete or normal.



**NOTE: “Set dedicated spare” is not available if there is no RG, or if RG is set to RAID 0 or JBOD, because user can not set dedicated spare disk to RAID 0 & JBOD.**

Sometimes, rebuild is called recover; they are the same meaning. The following table is the relationship between RAID levels and rebuild.

<b>RAID 0</b>	Disk striping. No protection for data. RG fails if any hard drive fails or unplugs.
<b>RAID 1</b>	Disk mirroring over 2 disks. RAID 1 allows one hard drive fails or unplugging. Need one new hard drive to insert to the system and rebuild to be completed.
<b>N-way mirror</b>	Extension to RAID 1 level. It has N copies of the disk. N-way mirror allows N-1 hard drives failure or unplugging.
<b>RAID 3</b>	Striping with parity on the dedicated disk. RAID 3 allows one hard drive failure or unplugging.
<b>RAID 5</b>	Striping with interspersed parity over the member disks. RAID 5 allows one hard drive failure or unplugging.
<b>RAID 6</b>	2-dimensional parity protection over the member disks. RAID 6 allows two hard drives failure or unplugging. If it needs to rebuild two hard drives at the same time, it will rebuild the first one, then the other in sequence.
<b>RAID 0+1</b>	Mirroring of RAID 0 volumes. RAID 0+1 allows two hard drive failures or unplugging, but at the same array.
<b>RAID 10</b>	Striping over the member of RAID 1 volumes. RAID 10 allows two hard drive failure or unplugging, but in different arrays.
<b>RAID 30</b>	Striping over the member of RAID 3 volumes. RAID 30 allows two hard drive failure or unplugging, but in different arrays.
<b>RAID 50</b>	Striping over the member of RAID 5 volumes. RAID 50 allows two hard drive failures or unplugging, but in different arrays.
<b>RAID 60</b>	Striping over the member of RAID 6 volumes. RAID 40 allows four hard drive failures or unplugging, every two in different arrays.
<b>JBOD</b>	The abbreviation of “ <b>J</b> ust a <b>B</b> unch <b>O</b> f <b>D</b> isks”. No data protection. RG fails if any hard drive failures or unplugs.

## 6.2 RG Migration

To do migration, the total size of RG must be larger or equal to the original RG. It does not allow expanding the same RAID level with the same hard disks of original RG. Take examples as following.

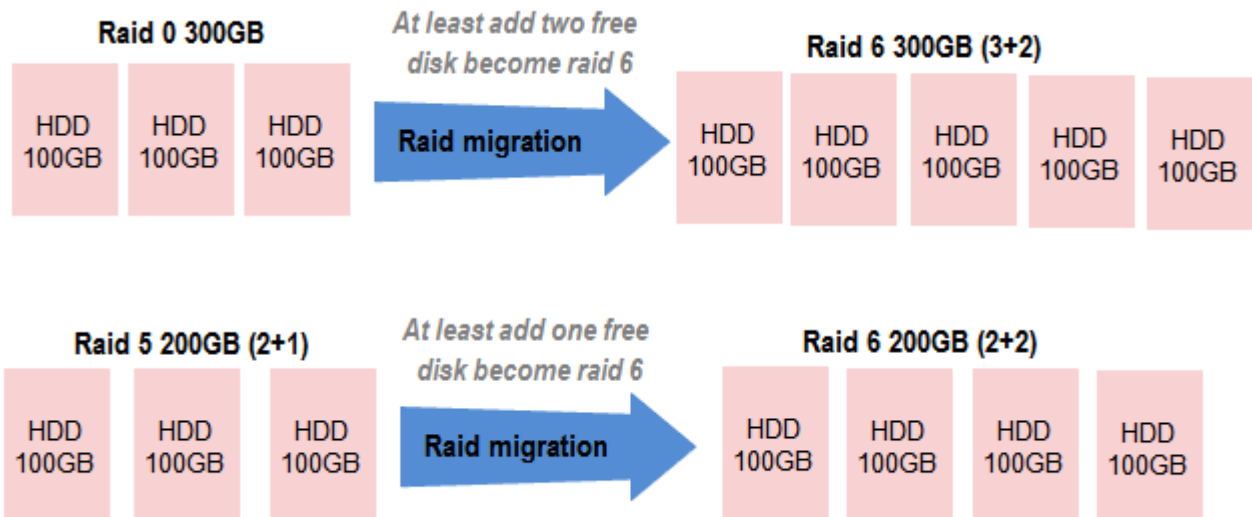

The below operations are not allowed when a RG is being migrated. System would reject these operations:

1. Add dedicated spare.
2. Remove a dedicated spare.
3. Create a new VD.
4. Delete a VD.
5. Extend a VD.
6. Scrub a VD.
7. Perform another migration operation.
8. Scrub entire RG.
9. Take a snapshot.
10. Delete a snapshot.
11. Expose a snapshot.
12. Rollback to a snapshot.



**IMPORTANT! RG Migration cannot be executed during rebuild or VD extension.**

To migrate the RAID level, please follow below procedures.

1. Select **"/ Volume configuration / RAID group"**.
2. Check the gray button next to the RG number; click **"Migrate"**.
3. Change the RAID level by clicking the down arrow to **"RAID 5"**. There will be a pup-up which indicates that HDD is not enough to support the new setting of RAID level, click **"Select PD"** to increase hard drives, then click **"OK"** to go back to setup page. When doing migration to lower RAID level, such as the original RAID level is RAID 6 and user wants to migrate to RAID 0, system will evaluate whether this operation is safe or not, and appear a warning message of **"Sure to migrate to a lower protection array?"**.



4. Double check the setting of RAID level and RAID PD slot. If there is no problem, click **"OK"**.
5. Finally a confirmation page shows the detail of RAID information. If there is no problem, click **"OK"** to start migration. System also pops up a message of **"Warning: power lost during migration may cause damage of data!"** to give user warning. When the power is abnormally off during the migration, the data is in high risk.
6. Migration starts and it can be seen from the **"status"** of a RG with **"Migrating"**. In **"/ Volume configuration / Virtual disk"**, it displays a **"Migrating"** in **"Status"** and complete percentage of migration in **"R%"**.

Show size unit as: (GB)

	Name	Total(GB)	Free(GB)	#PD	#VD	Status	Health	RAID	Current owner	Preferred owner
OP.	RG-R0->R5	1396	1386	4	1	Migrating	Good	RAID 5	Controller 1	Controller 1

**A RAID 0 with 3 physical disks migrates to RAID 5 with 4 physical disks.**

Show size unit as: (GB)

	Name	Size(GB)	Write	Priority	Bg rate	Type	Clone	Schedule	Status	Health	R %	RAID	#LUN	Snapshot space(GB)	#Snapshot	RG
OP.	VD-R0->R5	10	WB	HI	4	RAID	N/A	N/A	Migrating	Optimal	3	RAID 5	0	0/0	0	RG-R0->R5

## 6.3 VD Extension

To extend VD size, please follow the procedures.

1. Select “/ **Volume configuration / Virtual disk**”.
2. Check the gray button next to the VD number; click “**Extend**”.
3. Change the size. The size must be larger than the original, and then click “**OK**” to start extension.

4. Extension starts. If VD needs initialization, it will display an “**Initiating**” in “**Status**” and complete percentage of initialization in “**R%**”.

Show size unit as: (GB)

	Name	Size(GB)	Write	Priority	Bg rate	Type	Clone	Schedule	Status	Health	R %	RAID	#LUN	Snapshot space(GB)	#Snapshot	RG
OP	VD-R0->R5	20	WB	HI	4	RAID	N/A	N/A	Initiating	Optimal	46	RAID 5	0	0/0	0	RG-R0->R5



**NOTE: The size of VD extension must be larger than original.**



**IMPORTANT! VD Extension cannot be executed during rebuild or migration.**

## 6.4 Snapshot / Rollback

**Snapshot-on-the-box** captures the instant state of data in the target volume in a logical sense. The underlying logic is Copy-on-Write -- moving out the data which would be written to certain location where a write action occurs since the time of data capture. The certain location, named as "Snap VD", is essentially a new VD, which can be attached to a LUN provisioned to a host as a disk like other ordinary VDs in the system. Rollback restores the data back to the state of any time which was previously captured in case for any unfortunate reason it might be (e.g. virus attack, data corruption, human errors and so on). Snap VD is allocated within the same RG in which the snapshot is taken, we suggest to reserve 20% of RG size or more for snapshot space. Please refer to the figure below for the snapshot concept.

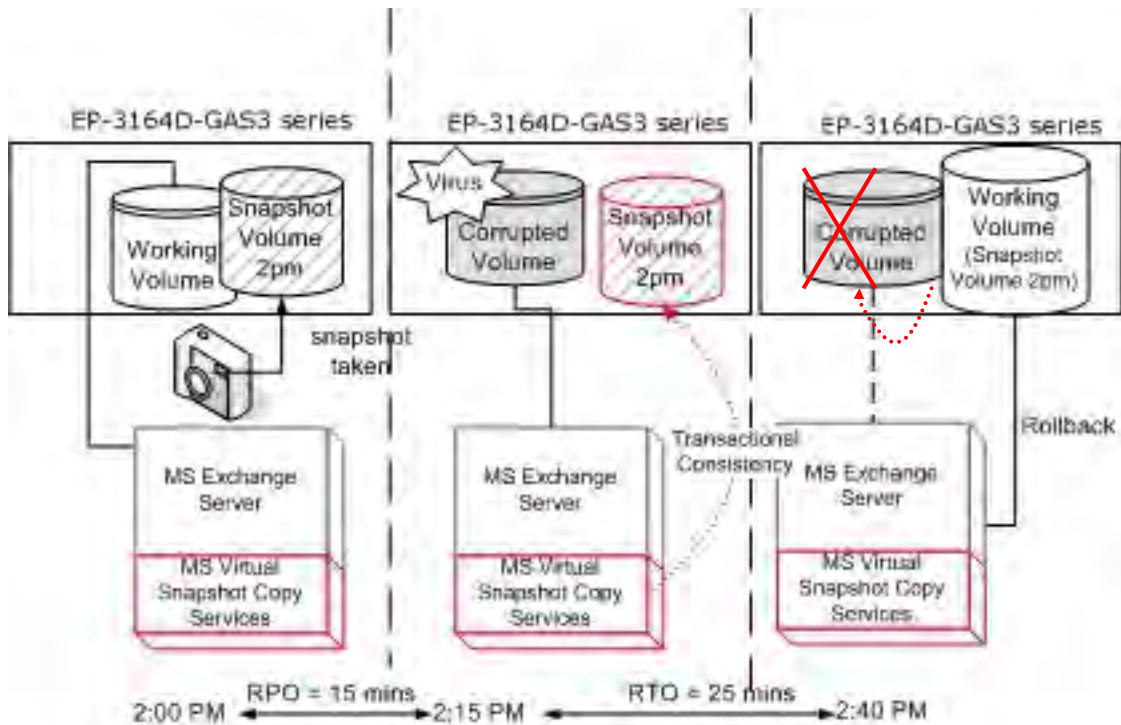

**IMPORTANT! Snapshot / rollback features need at least 1 GB controller cache RAM. Please also refer to RAM certification list in Appendix A.**

### 6.4.1 Create Snapshot Volume

To take a snapshot of the data, please follow the procedures.

1. Select “/ **Volume configuration / Virtual disk**”.
2. Move the mouse pointer to the gray button next to the VD number; click “**Set snapshot space**”.
3. Set up the size for snapshot. The minimum size is suggested to be **20%** of VD size, then click “**OK**”. It will go back to the VD page and the size will show in snapshot column. It may not be the same as the number entered because some size is reserved for snapshot internal usage. There will be 2 numbers in “**Snapshot (MB)**” column. These numbers are “**Used snapshot space**” and “**Total snapshot space**”.
4. There are two methods to take snapshot. In “/ **Volume configuration / Virtual disk**”, move the mouse pointer to the gray button next to the VD number; click “**Take snapshot**”. Or in “/ **Volume configuration / Snapshot**”, click “**Take snapshot**”.
5. Enter a snapshot name, then click “**OK**”. A snapshot VD is created.
6. Select “/ **Volume configuration / Snapshot**” to display all snapshot VDs related to the VD

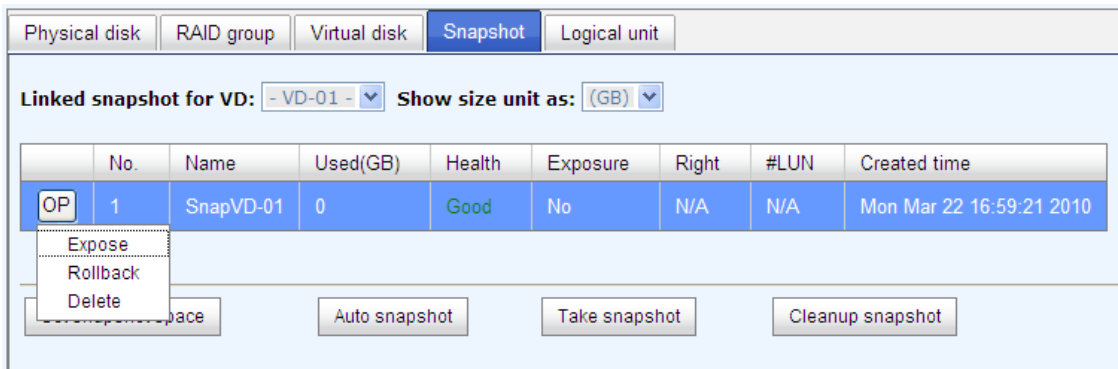

7. Move the mouse pointer to the gray button next to the Snapshot VD number; click “**Expose**”. Enter a capacity for snapshot VD. If size is zero, the exposed snapshot VD will be read only. Otherwise, the exposed snapshot VD can be read / written, and the size will be the maximum capacity to read/write.
8. Attach a LUN for snapshot VD. Please refer to the previous chapter for attaching a LUN.
9. Done. It can be used as a disk.

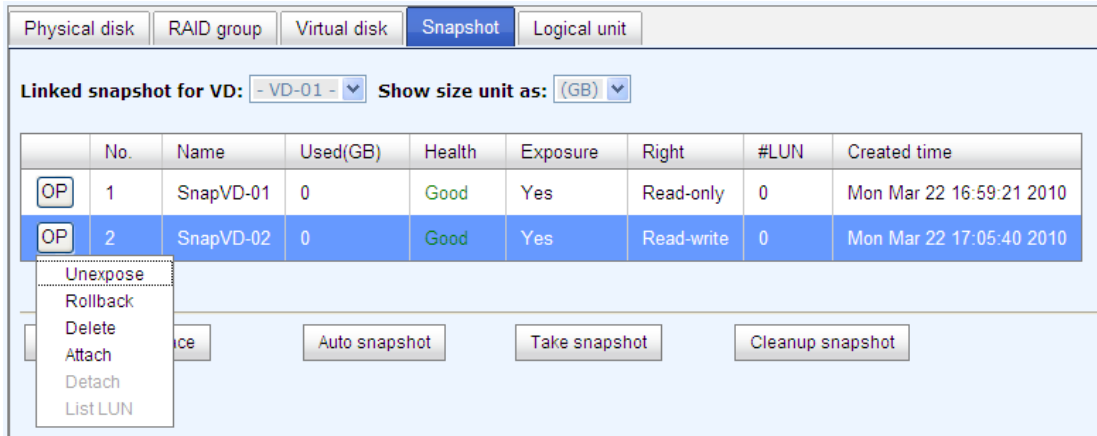

This is the snapshot list of "VD-01". There are two snapshots. Snapshot VD "SnapVD-01" is exposed as read-only, "SnapVD-02" is exposed as read-write.

10. There are two methods to clean all snapshots. In **"/ Volume configuration / Virtual disk"**, move the mouse pointer to the gray button next to the VD number; click **"Cleanup snapshot"**. Or in **"/ Volume configuration / Snapshot"**, click **"Cleanup"**.
11. **"Cleanup snapshot"** will delete all snapshots related to the VD and release snapshot space.

## 6.4.2 Auto Snapshot

The snapshot copies can be taken manually or by schedule such as hourly or daily. Please follow the procedures.

1. There are two methods to set auto snapshot. In **"/ Volume configuration / Virtual disk"**, move the mouse pointer to the gray button next to the VD number; click **"Auto snapshot"**. Or in **"/ Volume configuration / Snapshot"**, click **"Auto snapshot"**.
2. The auto snapshot can be set monthly, weekly, daily, or hourly.
3. Done. It will take snapshots automatically.



Auto snapshot

- VD-R0->R5 -

**Months to take snapshots :**  All  
 01  02  03  04  
 05  06  07  08  
 09  10  11  12

**Weeks to take snapshots :**  All  
 1  2  3  4  
 5

**Days to take snapshots :**  All  
 Sun  Mon  Tue  Wed  
 Thu  Fri  Sat

**Hours to take snapshots :**  All  
 00  01  02  03  
 04  05  06  07  
 08  09  10  11  
 12  13  14  15  
 16  17  18  19  
 20  21  22  23

OK Cancel

It will take snapshots every month, and keep the last 32 snapshot copies.



**NOTE: Daily snapshot will be taken every 00:00. Weekly snapshot will be taken every Sunday 00:00. Monthly snapshot will be taken every first day of month 00:00.**

### 6.4.3 Rollback

The data in snapshot VD can rollback to original VD. Please follow the steps.

1. Select “/ **Volume configuration / Snapshot**”.
2. Mouse moves to the gray button next to the Snap VD number which user wants to rollback the data; click “**Rollback**”.
3. Done, the data in snapshot VD will rollback to original VD.

Rollback has some constraints as described in the following:

1. Minimum RAM size required for enabling rollback is **1GB**.
2. When making a rollback, the original VD cannot be accessed for a while. At the same time, the system connects to original VD and snapshot VD, and then starts rollback.

3. During rollback, data from snapshot VD to original VD, the original VD can be accessed and the data in VD just like it has finished rollback. At the same time, the other related snap VD(s) cannot be accessed.
4. After rollback, the other snapshot VD(s) after the VD which is doing rollback will be deleted.



**IMPORTANT! Before executing rollback, it is better to dismount the file system for flushing data from cache to disks in OS first. System sends pop-up message when user executes rollback function.**

## 6.5 Disk Roaming

Physical disks can be re-sequenced in the same system or move all physical disks from system-1 to system-2. This is called disk roaming. System can execute disk roaming online. Please follow these steps:

1. Select **“/ Volume configuration / RAID group”**.
2. Check the gray button next to the RG number; click **“Deactivate”**.
3. Move all PDs related to the RG to another system.
4. In the web GUI of the other system, check the gray button next to the RG number; click **“Activate”**.
5. Done.

Disk roaming has some constraints as described in the following:

1. Check the firmware of two systems first. It is better that both systems have the same firmware version or newer.
2. All physical disks of related RG should be moved from system-1 to system-2 together. The configuration of both RG and VD will be kept but LUN configuration will be cleared in order to avoid conflict with system-2.

## 6.6 VD Clone

The user can use VD clone function to backup data from source VD to target VD, set up backup schedule, and deploy the clone rules.

The procedures of VD clone are on the following:

1. Copy all data from source VD to target VD at the beginning (full copy).
2. Use snapshot technology to perform the incremental copy afterwards. Please be fully aware that the incremental copy needs to use snapshot to compare the data difference. Therefore, the enough snapshot space for VD clone is very important.

The following contents will take an example of a RAID 5 virtual disk (SourceVD\_Raid5) clone to RAID 6 virtual disk (TargetVD\_Raid6).

- **Start VD clone**

1. Create a RAID group (RG) in advance.

Show size unit as: (GB) ▾

	Name	Total(GB)	Free(GB)	#PD	#VD	Status	Health	RAID	Current owner	Preferred owner
OP.	RG-R5	931	931	3	0	Online	Good	RAID 5	Controller 1	Controller 1
OP.	RG-R6	931	931	4	0	Online	Good	RAID 6	Controller 1	Controller 1

2. Create two virtual disks (VD) "SourceVD\_R5" and "TargetVD\_R6". The raid type of backup target needs to be set as "**BACKUP**".

**Create**

**Name :** TargetVD\_R6

**RG name :** RG-R6 ▾

**Capacity :** 20 GB ▾

**Stripe height (KB) :** 64 ▾

**Block size (B) :** 512 ▾

**Read/Write :**  Write-through cache  Write-back cache ⓘ

**Priority :**  High priority  Middle priority  Low priority

**Bg rate :** 4 ⓘ

**Readahead :** Enabled ⓘ

**AV-media mode :** Disabled ▾

**Erase :** None ▾

**Type :** BACKUP ▾  
RAID  
BACKUP

OK Cancel

- Here are the objects, a Source VD and a Target VD. Before starting clone process, it needs to deploy the VD Clone rule first. Click **“Configuration”**.

Show size unit as: (GB)

	Name	Size(GB)	Write	Priority	Bg rate	Type	Clone	Schedule	Status	Health	R %	RAID	#LUN	Snapshot space(GB)	#Snapshot	RG
<span>OP</span>	SourceVD_R5	20	WB	HI	4	RAID	N/A	N/A	Online	Optimal		RAID 5	0	0/0	0	RG-R5
<span>OP</span>	TargetVD_R6	20	WB	HI	4	BACKUP	N/A	N/A	Online	Optimal		RAID 6	0	0/0	0	RG-R6

Create Configuration

- There are three clone configurations, describe on the following.

**Clone - Configuration**

**Snapshot space :** 2

**Threshold :** 50%

**Restart the task an hour later if failed :**

OK Cancel

- Snapshot space:**

**Clone - Configuration**

**Snapshot space :** 2

**Threshold :**

**Restart the task an hour later if failed**

This setting is the ratio of source VD and snapshot space. The default ratio is 2 to 1. It means when the clone process is starting, the system will automatically use the free RG space to create a snapshot space which capacity is double the source VD.

- Threshold: (The setting will be effective after enabling schedule clone)**

**Clone - Configuration**

**Snapshot space :** 2

**Threshold :** 50%

**Restart the task an hour later if failed**

The threshold setting will monitor the usage amount of snapshot space. When the used snapshot space achieves its threshold, system will automatically take a clone snapshot and start VD clone process. The purpose of threshold could prevent the incremental copy fail immediately when running out of snapshot space.

For example, the default threshold is 50%. The system will check the snapshot space every hour. When the snapshot space is used over 50%, the system will synchronize the source VD and target VD automatically. Next time, when the rest snapshot space has been used 50%, in other words, the total snapshot space has been used 75%, and the system will synchronize the source VD and target VD again.

- **Restart the task an hour later if failed: (The setting will be effective after enabling schedule clone)**

The image shows a dialog box titled "Clone - Configuration". It contains three settings:

- Snapshot space :** A dropdown menu set to "2".
- Threshold :** A dropdown menu set to "50%".
- Restart the task an hour later if failed :** A checked checkbox.

When running out of snapshot space, the VD clone process will be stopped because there is no more available snapshot space. If this option has been checked, system will clear the snapshots of clone in order to release snapshot space automatically, and the VD clone will restart the task after an hour. This task will start a full copy.

5. After deploying the VD clone rule, the VD clone process can be started now. Firstly, Click **"Set clone"** to set the target VD at the VD name "SourceVD\_R5".

Show size unit as: (GB) ▾

	Name	Size(GB)	Write	Priority	Bg rate	Type	Clone	Schedule
OP.	SourceVD_R5	20	WB	HI	4	RAID	N/A	N/A
		20	WB	HI	4	BACKUP	N/A	N/A

A context menu is open over the first row of the table, listing various actions. The "Set clone" option is highlighted.

- Extend
- Parity check
- Delete
- Set property
- Attach LUN
- Detach LUN
- List LUN
- Set clone**
- Set snapshot space
- Cleanup snapshot
- Take snapshot
- Auto snapshot
- List snapshot
- More information

6. Select the target VD. Then click **“Confirm”**.



7. Now, the clone target “TargetVD\_R6” has been set.

Show size unit as: (GB) ▾

	Name	Size(GB)	Write	Priority	Bg rate	Type	Clone	Schedule
OP.	SourceVD_R5	20	WB	HI	4	RAID	TargetVD_R6	N/A
OP.	TargetVD_R6	20	WB	HI	4	BACKUP	N/A	N/A

8. Click **“Start clone”**, the clone process will start.

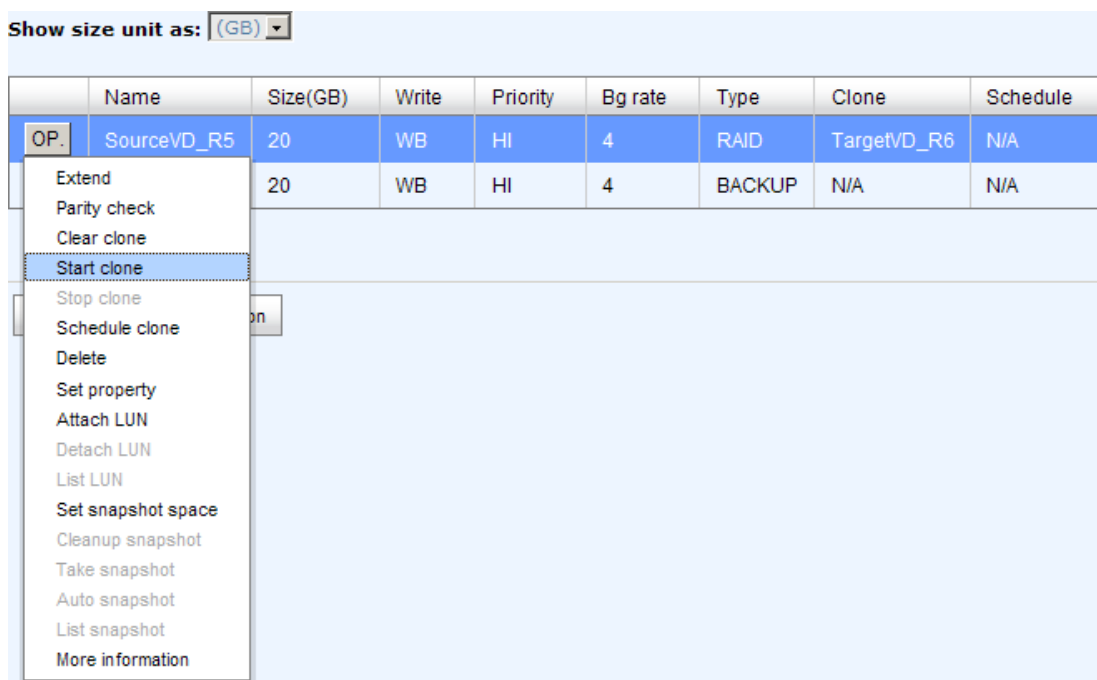

9. The default setting will create a snapshot space automatically which the capacity is double size of the VD space. Before starting clone, system will initiate the snapshot space.

Show size unit as: (GB) ▾

	Name	Size(GB)	Write	Priority	Bg rate	Type	Clone	Schedule	Status	Health	R %	RAID	#LUN	Snapshot space(GB)	#Snapshot	RG
OP.	SourceVD_R5	20	WB	HI	4	RAID	TargetVD_R6	N/A	Initiating	Optimal	33	RAID 5	0	1/41	1	RG-R5
OP.	TargetVD_R6	20	WB	HI	4	BACKUP	N/A	N/A	Online	Optimal		RAID 6	0	0/0	0	RG-R6

10. After initiating the snapshot space, it will start cloning.

Show size unit as: (GB)

	Name	Size(GB)	Write	Priority	Bg rate	Type	Clone	Schedule	Status	Health	R %	RAID	#LUN	Snapshot space(GB)	#Snapshot	RG
OP.	SourceVD_R5	20	WB	HI	4	RAID	TargetVD_R6	N/A	Cloning	Optimal	37	RAID 5	0	1/41	1	RG-R5
OP.	TargetVD_R6	20	WB	HI	4	BACKUP	N/A	N/A	Online	Optimal		RAID 6	0	0/0	0	RG-R6

11. Click “Schedule clone” to set up the clone by schedule.

Show size unit as: (GB)

	Name	Size(GB)	Write	Priority	Bg rate	Type	Clone	Schedule
OP.	SourceVD_R5	20	WB	HI	4	RAID	TargetVD_R6	N/A
		20	WB	HI	4	BACKUP	N/A	N/A

- Extend
- Parity check
- Clear clone
- Start clone
- Stop clone
- Schedule clone**
- Delete
- Set property
- Attach LUN
- Detach LUN
- List LUN
- Set snapshot space
- Cleanup snapshot
- Take snapshot
- Auto snapshot
- List snapshot
- More information

12. There are “Set Clone schedule” and “Clear Clone schedule” in this page. Please remember that “Threshold” and “Restart the task an hour later if failed” options in VD configuration will take effect after clone schedule has been set.

Clone - Set Clone schedule

**Set Clone schedule**

Scheduled time : 00:00

**Back up everyday**

**Back up on a selected day in a week**

Sunday     Monday     Tuesday     Wednesday

Thursday     Friday     Saturday

**Back up on the 1st day in a month**

**Clear Clone schedule**

OK    Cancel

- **Run out of snapshot space while VD clone**

While the clone is processing, the increment data of this VD is over the snapshot space. The clone will complete, but the clone snapshot will fail. Next time, when trying to start clone, it will get a warning message "This is not enough of snapshot space for the operation". At this time, the user needs to clean up the snapshot space in order to operate the clone process. Each time the clone snapshot failed, it means that the system loses the reference value of incremental data. So it will start a full copy at next clone process.

When running out of snapshot space, the flow diagram of VD clone procedure will be like the following.

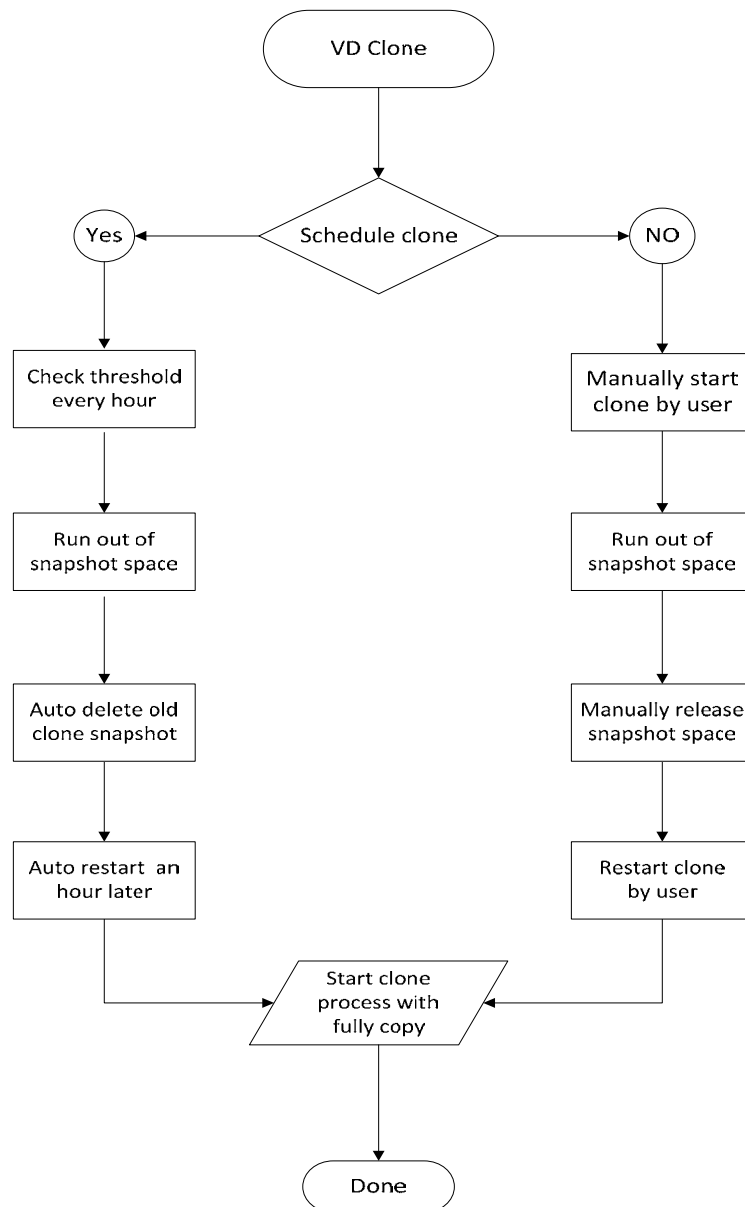



## 6.7 SAS JBOD Expansion

### 6.7.1 Connecting JBOD

iSCSI RAID controller supports SAS JBOD expansion to connect extra SAS dual JBOD controller. When connecting a dual JBOD controller which can be detected in RAID Subsystem management GUI, it will be displayed in **“Show PD for:”** under **“/ Volume configuration / Physical disk”** menu. For example, Local, JBOD 1, JBOD 2, ...etc. Local means disks located in local RAID subsystem, JBOD 1 means disks located in first JBOD subsystem, and so on. The hard drives in JBOD can be used as local disks.

Physical disk													
		RAID group	Virtual disk	Snapshot	Logical unit	QReplica							
Show PD for:		-JBOD 1 (proIPS EP-3164JD-S6S6 v1.0.1) 5001378004B50190 -					Show size unit as: (GB)						
		- Local -											
		-JBOD 1 (proIPS EP-3164JD-S6S6 v1.0.1) 5001378004B50190 -											
		-JBOD 2 (proIPS EP-3164JD-S6S6 v1.0.1) 5001378004B50380 -											
		-JBOD 3 (proIPS EP-3164JD-S6S6 v1.0.1) 5001378004B501E0 -											
	Slot						Serial	Type	Write cache	Standby	Readahead	Command queuing	
OP	1	558	r50-1	Online	Good	RAID disk	WDC	WD-WXM1E60RW203	SATA2	Enabled	Disabled	Enabled	Disabled
OP	3	465	r6-3	Online	Good	RAID disk	WDC	WD-WCASY3223587	SATA2	Enabled	Disabled	Enabled	Disabled
OP	4	465	r6-3	Online	Good	RAID disk	WDC	WD-WMAYP0015736	SATA2	Enabled	Disabled	Enabled	Disabled
OP	5	558	r50-1	Online	Good	RAID disk	WDC	WD-WXM1E6070999	SATA2	Enabled	Disabled	Enabled	Disabled
OP	7	232		Online	Good	Free disk	Seagate	9QE6T6DW	SATA2	Enabled	Disabled	Enabled	Disabled
OP	8	465	r6-3	Online	Good	RAID disk	WDC	WD-WMAYP0015949	SATA2	Enabled	Disabled	Enabled	Disabled
OP	9	558	r50-1	Online	Good	RAID disk	WDC	WD-WXM1E6070513	SATA2	Enabled	Disabled	Enabled	Disabled
OP	12	465	r6-3	Online	Good	RAID disk	WDC	WD-WMAYP0014684	SATA2	Enabled	Disabled	Enabled	Disabled
OP	13	558	r50-1	Online	Good	RAID disk	WDC	WD-WXM1E6071038	SATA2	Enabled	Disabled	Enabled	Disabled
OP	15	232		Online	Good	Free disk	Seagate	5QE5FK6D	SATA2	Enabled	Disabled	Enabled	Disabled
OP	16	465	r6-3	Online	Good	RAID disk	WDC	WD-WMAYP0015624	SATA2	Enabled	Disabled	Enabled	Disabled

“/ Enclosure management / Hardware monitor” can display the hardware status of SAS JBODs.

Hardware monitor    UPS    SES    S.M.A.R.T.

Show information for: - JBOD 1 (proIPS EP-3164JD-S6S6 v1.0.1) 5001378004B50190 -

**Controller 1 (50013780049007BD)**

<< first < prev 1 2 next > last >>

Type	Item	Value	Status
Voltage	PSU +3.3V(R6R)	3.36 V	OK
Voltage	PSU +5V(R6R)	5.10 V	OK
Voltage	PSU +12V(R6R)	12.31 V	OK
Voltage	+1.0V (Onboard)	0.99 V	OK
Voltage	+1.8V (Onboard)	1.84 V	OK
Voltage	+3.3V (Onboard)	3.34 V	OK
Voltage	+5V (Onboard)	5.10 V	OK
Voltage	+12V (Onboard)	12.27 V	OK
Temperature	Location 1(R6R)	26.0 (C)	OK
Temperature	Location 2(R6R)	25.0 (C)	OK
Temperature	Location 3(R6R)	26.0 (C)	OK
Temperature	Location 4(R6R)	26.0 (C)	OK
Temperature	Location 5(R6R)	26.0 (C)	OK
Temperature	Location 6(R6R)	24.0 (C)	OK
Temperature	Location 7(R6R)	26.0 (C)	OK
Temperature	Location 8(R6R)	27.0 (C)	OK
Temperature	Location 9(R6R)	26.0 (C)	OK
Temperature	Location 10(R6R)	24.0 (C)	OK
Temperature	Location 11(R6R)	26.0 (C)	OK
Temperature	Location 12(R6R)	28.0 (C)	OK

<< first < prev 1 2 next > last >>

**Controller 2 (500137800490057D)**

<< first < prev 1 2 next > last >>

Type	Item	Value	Status
Voltage	PSU +3.3V(R6R)	3.36 V	OK
Voltage	PSU +5V(R6R)	5.10 V	OK
Voltage	PSU +12V(R6R)	12.31 V	OK
Voltage	+1.0V (Onboard)	1.01 V	OK
Voltage	+1.8V (Onboard)	1.84 V	OK
Voltage	+3.3V (Onboard)	3.36 V	OK
Voltage	+5V (Onboard)	5.12 V	OK
Voltage	+12V (Onboard)	12.27 V	OK
Temperature	Location 1(R6R)	26.0 (C)	OK
Temperature	Location 2(R6R)	25.0 (C)	OK
Temperature	Location 3(R6R)	26.0 (C)	OK
Temperature	Location 4(R6R)	26.0 (C)	OK
Temperature	Location 5(R6R)	26.0 (C)	OK
Temperature	Location 6(R6R)	24.0 (C)	OK
Temperature	Location 7(R6R)	26.0 (C)	OK
Temperature	Location 8(R6R)	27.0 (C)	OK
Temperature	Location 9(R6R)	26.0 (C)	OK
Temperature	Location 10(R6R)	24.0 (C)	OK
Temperature	Location 11(R6R)	26.0 (C)	OK
Temperature	Location 12(R6R)	28.0 (C)	OK

<< first < prev 1 2 next > last >>

Hardware monitor    UPS    SES    S.M.A.R.T.

Show information for: **- JBOD 1 (proIPS EP-3164JD-S6S6 v1.0.1) 5001378004B50190 -**

**Controller 1 (50013780049007BD)**

<< first < prev **1** 2 next > last >>

Type	Item	Value	Status
Temperature	Location 13(R6R)	26.0 (C)	OK
Temperature	Location 14(R6R)	24.0 (C)	OK
Temperature	Location 15(R6R)	26.0 (C)	OK
Temperature	Location 16(R6R)	28.0 (C)	OK
Temperature	Onboard 1	71.0 (C)	OK
Temperature	Onboard 2	40.0 (C)	OK
Temperature	Onboard 3	37.0 (C)	OK
Power Supply	PSU 1	N/A	OK
Power Supply	PSU 2	N/A	OK
Cooling	FAN 1	4380 RPM	OK
Cooling	FAN 2	4380 RPM	OK
Cooling	FAN 3	4440 RPM	OK
Cooling	FAN 4	3970 RPM	OK

<< first < prev **1** 2 next > last >>

**Controller 2 (500137800490057D)**

<< first < prev **1** **2** next > last >>

Type	Item	Value	Status
Voltage	PSU +3.3V(R6R)	3.38 V	OK
Voltage	PSU +5V(R6R)	5.10 V	OK
Voltage	PSU +12V(R6R)	12.31 V	OK
Voltage	+1.0V (Onboard)	1.01 V	OK
Voltage	+1.8V (Onboard)	1.84 V	OK
Voltage	+3.3V (Onboard)	3.36 V	OK
Voltage	+5V (Onboard)	5.12 V	OK
Voltage	+12V (Onboard)	12.27 V	OK
Temperature	Location 1(R6R)	26.0 (C)	OK
Temperature	Location 2(R6R)	25.0 (C)	OK
Temperature	Location 3(R6R)	26.0 (C)	OK
Temperature	Location 4(R6R)	26.0 (C)	OK
Temperature	Location 5(R6R)	26.0 (C)	OK
Temperature	Location 6(R6R)	24.0 (C)	OK
Temperature	Location 7(R6R)	26.0 (C)	OK
Temperature	Location 8(R6R)	27.0 (C)	OK
Temperature	Location 9(R6R)	26.0 (C)	OK
Temperature	Location 10(R6R)	24.0 (C)	OK
Temperature	Location 11(R6R)	26.0 (C)	OK
Temperature	Location 12(R6R)	27.0 (C)	OK

<< first < prev **1** **2** next > last >>



“ / Enclosure management / S.M.A.R.T.” can display S.M.A.R.T. information of all PDs, including Local and all SAS JBODs.

The screenshot shows the S.M.A.R.T. (Self-Monitoring Analysis and Reporting Technology) interface. It includes a navigation bar with 'Hardware monitor', 'UPS', 'SES', and 'S.M.A.R.T.' tabs. Below the tabs, there is a title 'Self-Monitoring Analysis and Reporting Technology(S.M.A.R.T.)' and a brief description: 'A diagnostic tool for hard drives to deliver warning of drive failures in advance. S.M.A.R.T. provides users chances to take actions before possible drive failure.' A dropdown menu labeled 'Show information for:' is set to '- JBOD 1 (proIPS EP-3164JD-S6S6 v1.0.1) 5001378004B50190 -'. Below this is a table with columns: Slot, HDD type, Seek error (rate), Spin up (retries), Calibration (retries), and Temperature (C).

Slot	HDD type	Seek error (rate)	Spin up (retries)	Calibration (retries)	Temperature (C)
1	SATA2	200(0)	100(0)	100(0)	28
3	SATA2	200(51)	160(21)	200(140)	33
4	SATA2	200(51)	141(21)	200(140)	29
5	SATA2	200(51)	100(21)	200(140)	27
7	SATA2	114(6)	97(0)	100(36)	33
8	SATA2	200(51)	141(21)	200(140)	30
9	SATA2	200(51)	100(21)	200(140)	28
12	SATA2	200(51)	137(21)	200(140)	29
13	SATA2	200(51)	100(21)	200(140)	28
15	SATA2	108(6)	97(0)	100(36)	33
16	SATA2	200(51)	137(21)	200(140)	30

SAS JBOD expansion has some constraints as described in the followings:

- 1 User can create RAID group among multiple chassis/enclosures; the maximum number of disks in a single RAID group is 32.
- 2 Global spare disk can support all RAID groups which can be located in the different chassis/enclosure.
- 3 When support SATA drives for the redundant JBOD model, the SAS-SATA Bridge board is required. The SATA Dongle board does not apply to this model.

## 6.8 MPIO and MC/S

These features come from iSCSI initiator. They can be setup from iSCSI initiator to establish redundant paths for sending I/O from the initiator to the target.

1. **MPIO:** In Microsoft Windows server base system, Microsoft MPIO driver allows initiators to login multiple sessions to the same target and aggregate the duplicate devices into a single device. Each session to the target can be established using different NICs, network infrastructure and target ports. If one session fails, then another session can continue processing I/O without interruption to the application.

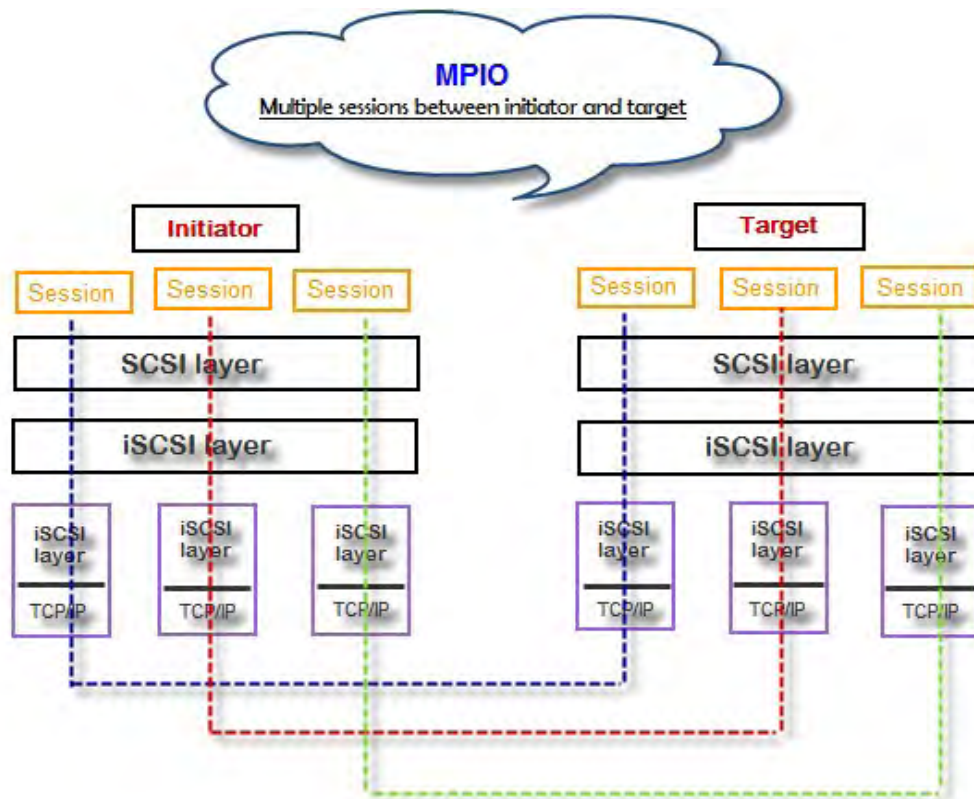

2. **MC/S:** MC/S (Multiple Connections per Session) is a feature of iSCSI protocol, which allows combining several connections inside a single session for performance and failover purposes. In this way, I/O can be sent on any TCP/IP connection to the target. If one connection fails, another connection can continue processing I/O without interruption to the application.

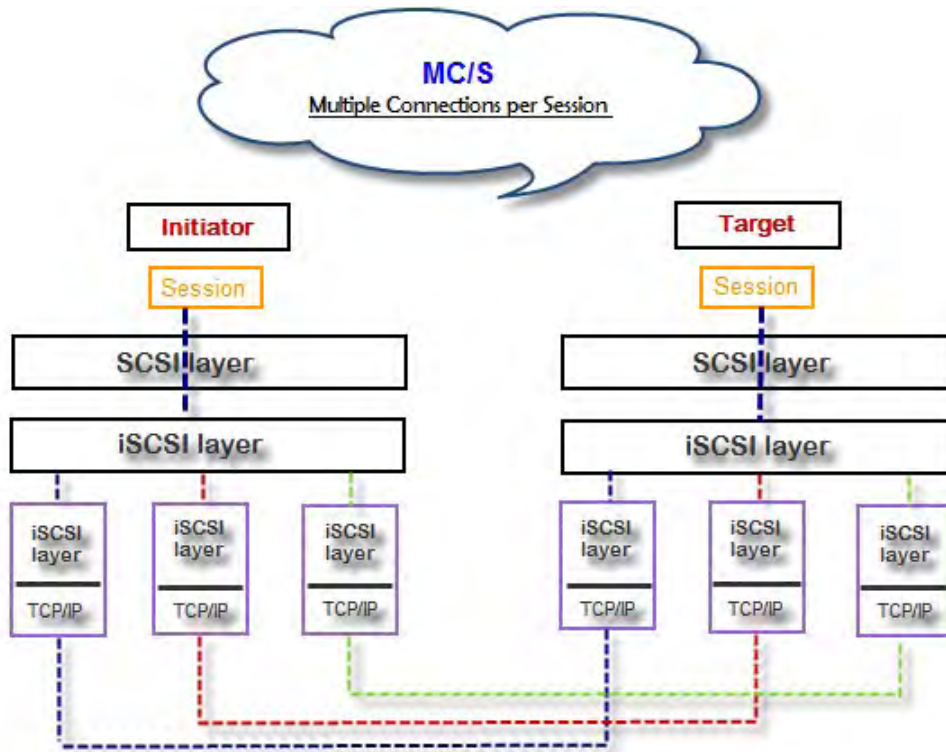

**Difference:**

MC/S is implemented on iSCSI level, while MPIO is implemented on the higher level. Hence, all MPIO infrastructures are shared among all SCSI transports, including Fiber Channel, SAS, etc. MPIO is the most common usage across all OS vendors. The primary difference between these two is which level the redundancy is maintained. MPIO creates multiple iSCSI sessions with the target storage. Load balance and failover occurs between the multiple sessions. MC/S creates multiple connections within a single iSCSI session to manage load balance and failover. Notice that iSCSI connections and sessions are different than TCP/IP connections and sessions. The above figures describe the difference between MPIO and MC/S.

There are some considerations when user chooses MC/S or MPIO for multipathing.

1. If user uses hardware iSCSI off-load HBA, then MPIO is the only one choice.
2. If user needs to specify different load balance policies for different LUNs, then MPIO should be used.
3. If user installs anyone of Windows XP, Windows Vista or Windows 7, MC/S is the only option since Microsoft MPIO is supported Windows Server editions only.
4. MC/S can provide higher throughput than MPIO in Windows system, but it consumes more CPU resources than MPIO.

## 6.9 Trunking and LACP

Link aggregation is the technique of taking several distinct Ethernet links to let them appear as a single link. It has a larger bandwidth and provides the fault tolerance ability. Beside the advantage of wide bandwidth, the I/O traffic remains operating until all physical links fail. If any link is restored, it will be added to the link group automatically. The iSCSI subsystem implements link aggregation as LACP and Trunking.

1. **LACP (IEEE 802.3ad):** The Link Aggregation Control Protocol (LACP) is a part of IEEE specification 802.3ad. It allows bundling several physical ports together to form a single logical channel. A network switch negotiates an automatic bundle by sending LACP packets to the peer. Theoretically, LACP port can be defined as active or passive. iSCSI controller implements it as active mode which means that LACP port sends LACP protocol packets automatically. Please notice that using the same configurations between iSCSI controller and gigabit switch.

The usage occasion of LACP:

- A. It's necessary to use LACP in a network environment of multiple switches. When adding new devices, LACP will separate the traffic to each path dynamically.

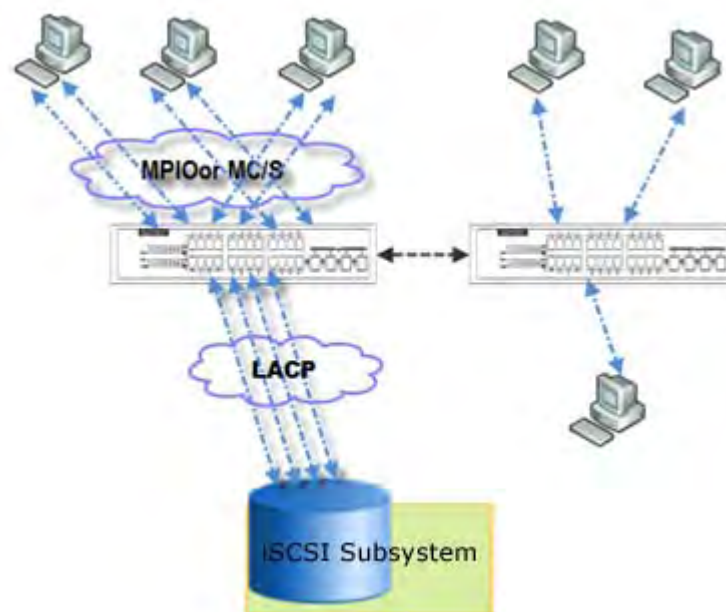

2. **Trunking (Non-protocol):** Defines the usage of multiple iSCSI data ports in parallel to increase the link speed beyond the limits of any single port.

The usage occasion of Trunking:

- A. This is a simple SAN environment. There is only one switch to connect the server and storage. And there is no extra server to be added in the future.
- B. There is no idea of using LACP or Trunking, uses Trunking first.
- C. There is a request of monitoring the traffic on a trunk in switch.



**IMPORTANT!** Before using trunking or LACP, the gigabit switch must support trunking or LACP and be enabled. Otherwise, the host cannot connect the link with the storage device.



## 6.10 Dual Controllers

### 6.10.1 Perform I/O

Please refer to the following topology and have all the connections ready. To perform I/O on dual controllers, server/host should setup MPIO. MPIO policy will keep I/O running and prevent fail connection with single controller failure.

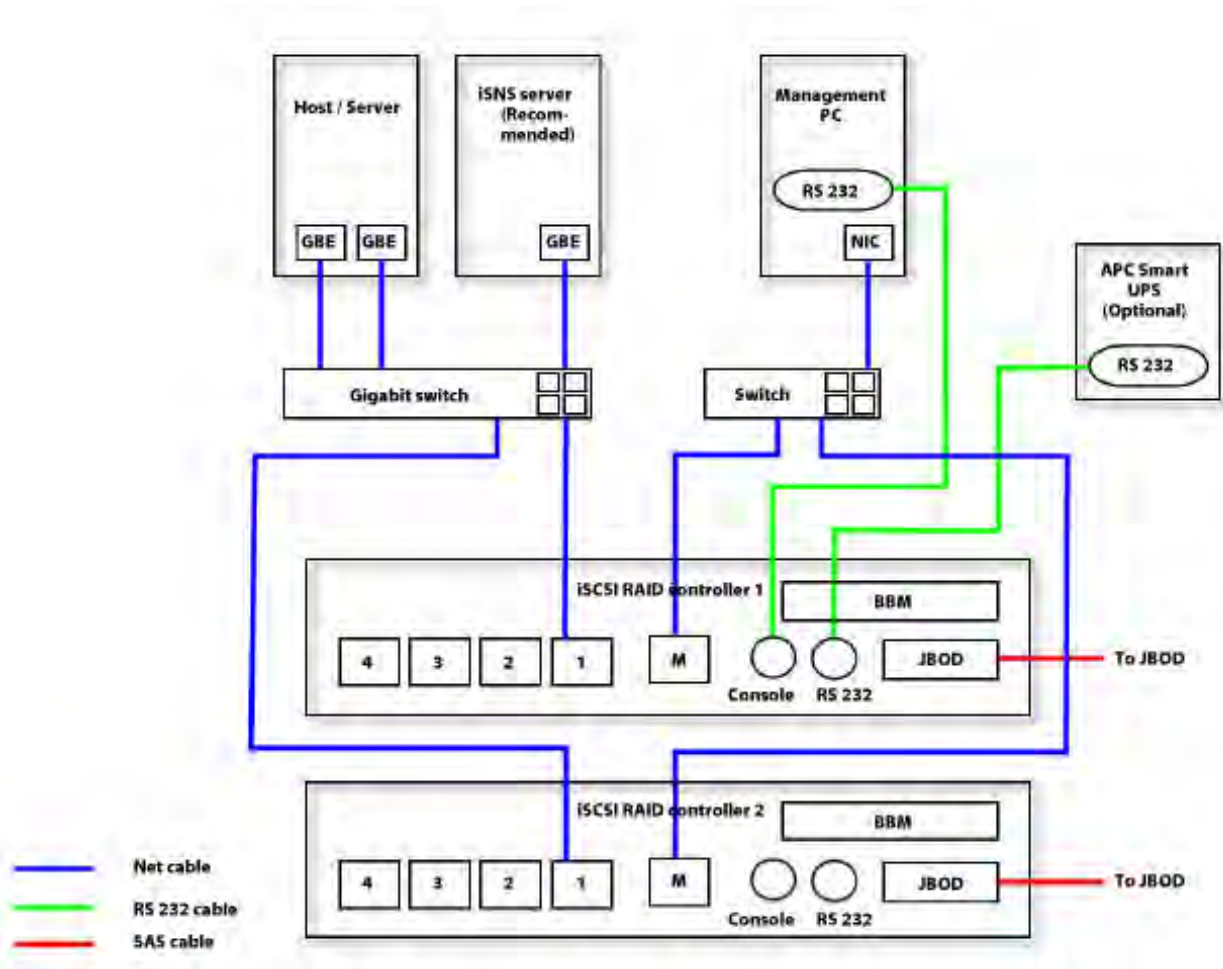

## 6.10.2 Ownership

When creating RG, it will be assigned with a preferred owner, the default owner is controller 1. To change the RG ownership, please follow the procedures.

1. Select “/ **Volume configuration / RAID group**”.
2. Check the gray button next to the RG name; click “**Set preferred owner**”.
3. The ownership of the RG will be switched to the other controller.

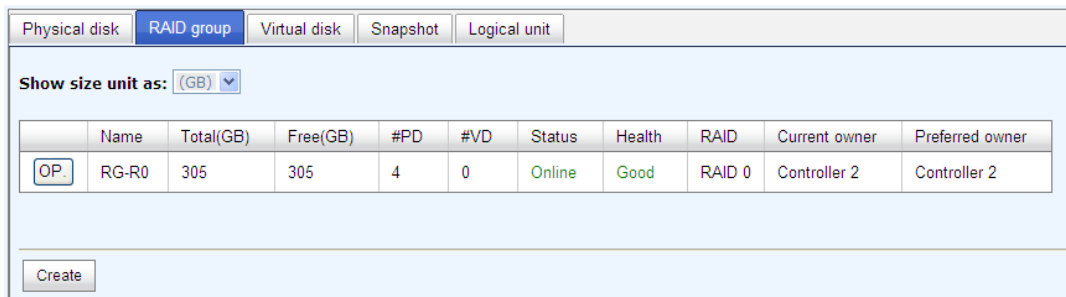
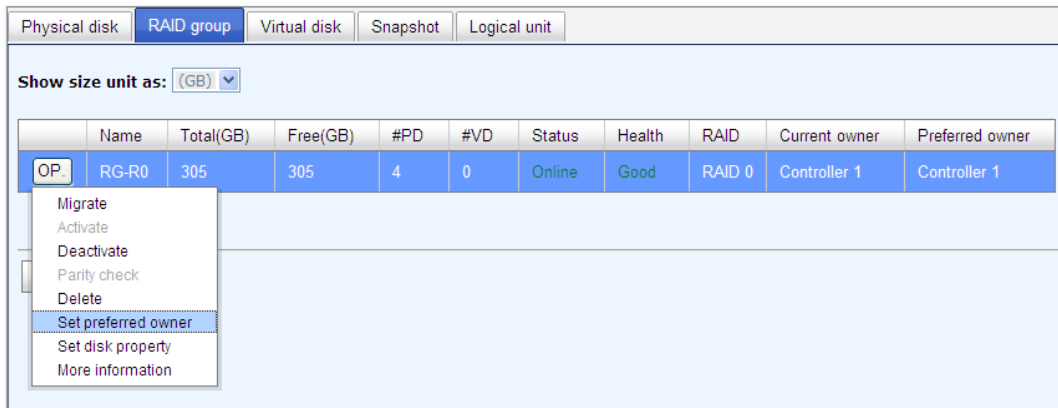

The RG ownership is changed to the other controller.

## 6.10.3 Controller Status

There are four statuses described on the following. It can be found in “/ **System maintenance / System information**”.

1. **Normal:** Dual controller mode. Both of controllers are functional.
2. **Degraded:** Dual controller mode. When one controller fails or has been plugged out, the system will turn to degraded. In this stage, I/O will force to write through for protecting data and the ownership of RG will switch to good one. For example: if controller 1 which owns the RG1 fails accidentally, the ownership of RG1 will be switched to controller 2 automatically. And the system and data can keep working well. After controller 1 is fixed or replaced, The current owner of all RGs will be assigned back to their preferred owner.

3. **Lockdown:** Dual controller mode. The firmware of two controllers is different or the size of memory of two controllers is different. In this stage, only master controller can work and I/O will force to write through for protecting data.
4. **Single:** Single controller mode. In the stage, the controller must stay in slot A. Dongle boards for SATA drives are not necessary. The differences between single and degraded are described on the following. There is no error message for inserted one controller only. I/O will not force to write through. And there is no ownership of RG. Single controller mode can be upgraded to dual controller mode, please contact the distributor for upgradable.

In addition, iSNS server is recommended. It's important for keeping I/O running smoothly when RG ownership is switching or single controller is failed. Without iSNS server, when controller 1 fails, the running I/O from host to controller 1 may fail because the time which host switches to the new portal is slower than I/O time out. With iSNS server, this case would not happen.



**NOTE: iSNS server is recommended for dual controller system.**

## 6.11 QReplica (Optional)

**QReplica** function will help users to replicate data easily through LAN or WAN from one subsystem to another.

The procedures of QReplica are on the following:

1. Copy all data from source VD to target VD at the beginning (full copy).
2. Use Snapshot technology to perform the incremental copy afterwards. Please be fully aware that the incremental copy needs to use snapshot to compare the data difference. Therefore, the enough snapshot space for VD clone is very important.

- **Activate the license key**

User needs to obtain a license key and download it to the RAID subsystem to activate the **QReplica** function. Each license key is unique and dedicated to a specific subsystem. It means that the license key for subsystem A cannot be used on another subsystem. To obtain the license key, please contact sales for assistance.

- **Setup the QReplica port on the source subsystem**

The **QReplica** uses the last iSCSI port on the controller to replicate the data. When the iSCSI is configured as **QReplica** port, it is no longer available for the host to connected as iSCSI port until it is configured as the normal iSCSI port again.

1. In the operation menu of the last iSCSI port on the controller, select "**Enable QReplica**" to set this port as the **QReplica** port. The last iSCSI port on controller 2 will also be set as the **QReplica** port automatically at the same time.

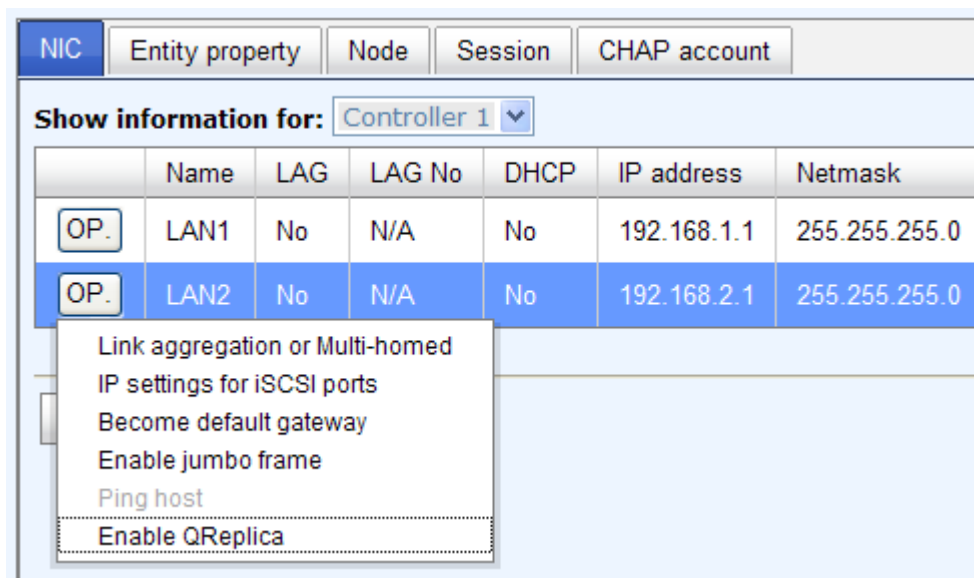

- The setting can be reverted by select **“Disable QReplica”** in the operation menu.

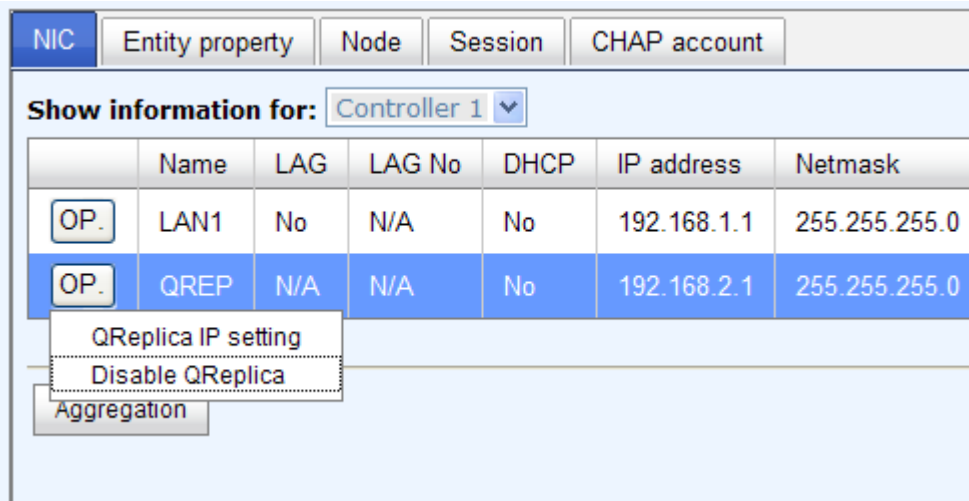

- Create backup VD on the target subsystem**

- Before creating the replication job on the source subsystem, user has to create a virtual disk on the target subsystem and set the type of the VD as **“Backup”**.

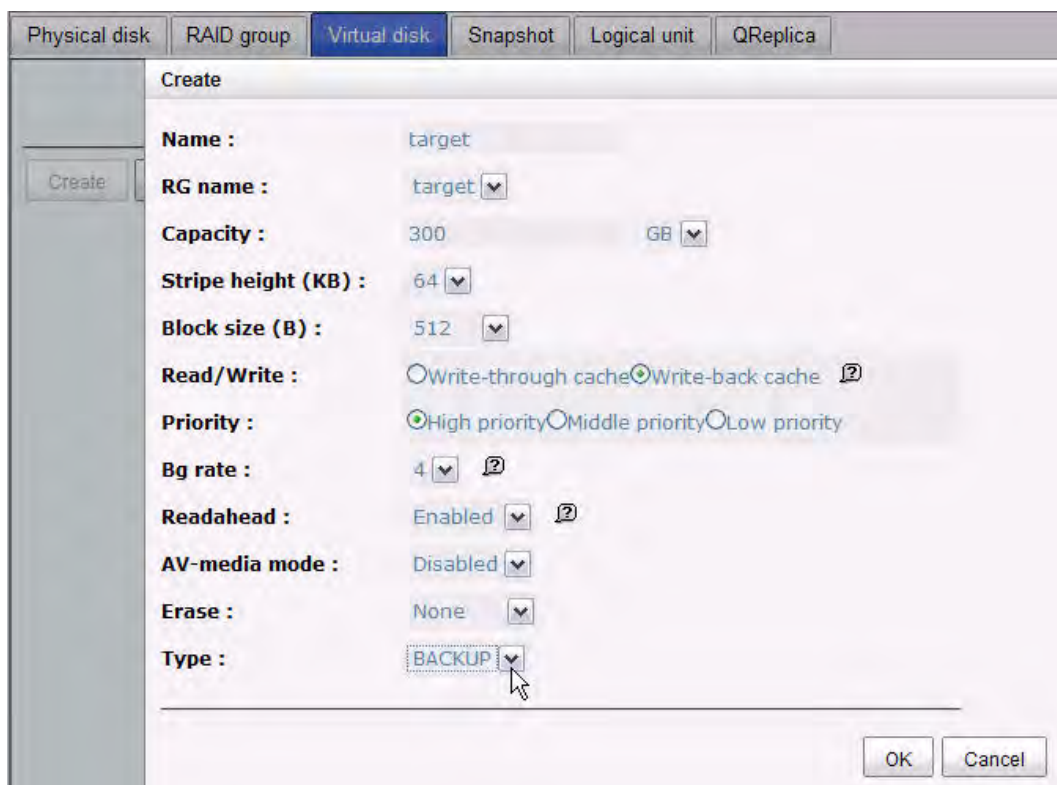

- The backup VD needs to be attached to a LUN ID first before creating replication job.



- Create replication job on the source subsystem**

- If the license key is activated on the subsystem correctly, a new **QReplica** tab will be added on the Web UI. Click **“Create”** to create a new replication job.

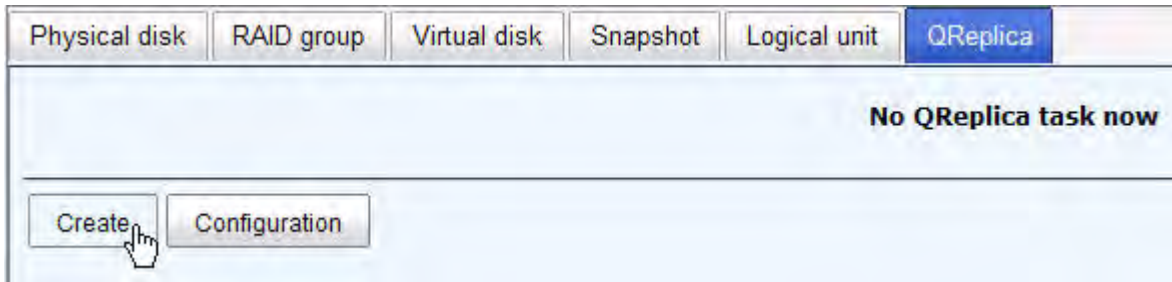

2. Select the source VD which will be replicated to the target subsystem and click **"Next"**.

QReplica - Select source VD

	Name	Size(GB)	Status	RAID	#LUN	#Snapshot	RG
<input checked="" type="radio"/>	SourceVD_R5	20	Online	RAID 5	0	0	RG-R5

Cancel Next >>



**NOTE:** If the message displays that there is not enough space for creation, please refer for the section of *Configure the snapshot space* below for solution.

3. Enter the IP address of iSCSI port on controller 1 of the target subsystem. Click **"Next"** to continue.

QReplica - Select target IP

IP :

Cancel << Back    Next >>

- The QReplca uses standard iSCSI protocol for data replication. User has to log on the iSCSI node to create the iSCSI connection for the data transmission. Enter the **CHAP** information if necessary and select the target node to log no. Click **“Next”** to continue.

**QReplca - Get login information**

**Choose authentication method.**

**No Authentication method**

CHAP

User :  (max: 223)

Secret :  (min: 12, max: 16)

**Select a target node**

No.	Name
<input checked="" type="radio"/> 1	iqn.1997-05.tw.com.proware:proips-000902298:dev0.ctr1

Cancel      << Back    Next >>

- Choose the backup VD and click **“Next”**.

**QReplca - Select target LUN**

No.	LUN	VD name	Size(GB)	Vendor	Model	Serial	Revision
<input checked="" type="radio"/> 1	1	target	300	Proware	proIPS	2104001378902298	200

Cancel      << Back    Next >>



6. A new replication job is created and listed on the **QReplica** page.

Physical disk											RAID group											Virtual disk											Snapshot											Logical unit											QReplica										
No.	VD name	Current owner	Target Name	Target IP	LUN	Name	Size(MB)	Size(GB)	Status	%																																																							
OP	1	source	Controller 1	iqn.1997-05.tw.com.proware.proips-000902298.dev0.ctr1	192.168.15.1	1	target	307200	300	Online																																																							

Create Configuration

- **Run the replication job**

1. Click the **"OP"** button on the replication job to open operation menu. Click **"Start"** to run the replication job.

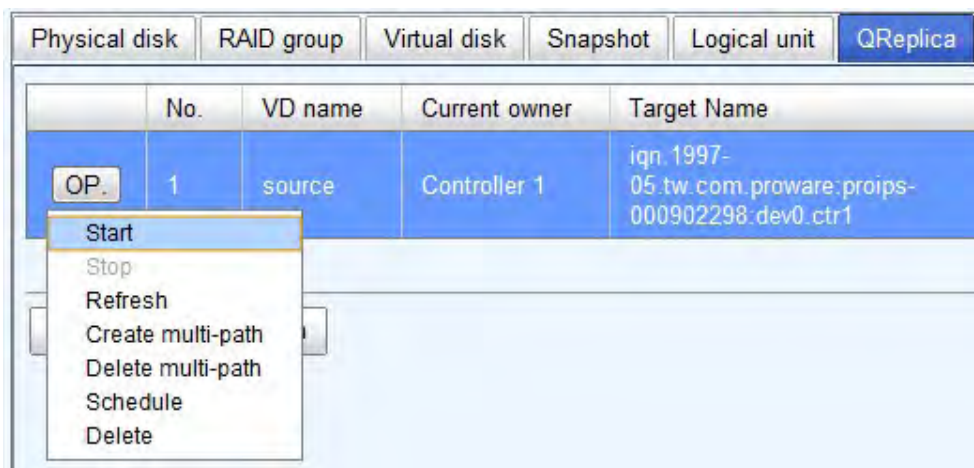

2. Click **"Start"** again to confirm the execution of the replication job.

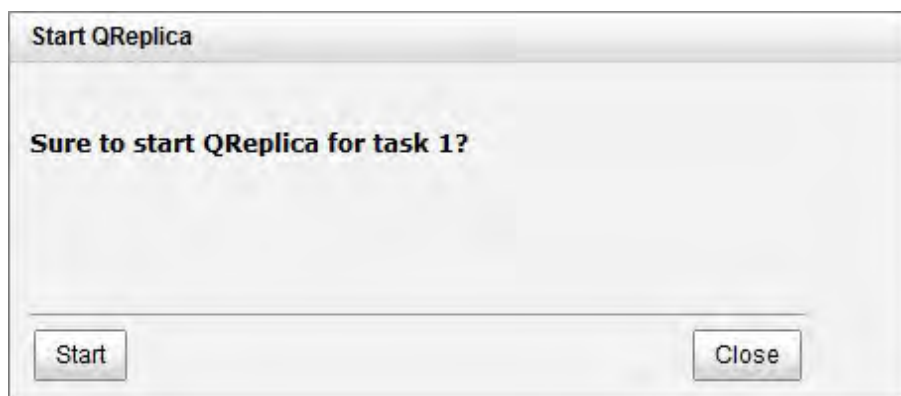

3. User can monitor the replication job from the **“Status”** information and the progress is expressed by percentage.

Physical disk											
RAID group											
Virtual disk											
Snapshot											
Logical unit											
QReplica											
	No.	VD name	Current owner	Target Name	Target IP	LUN	Name	Size(MB)	Size(GB)	Status	%
OP	1	source	Controller 1	iqn.1997-05.tw.com.proware.proips-000902298:dev0.ctr1	192.168.15.1	1	target	307200	300	Replicating	0

Create Configuration

- **Create multi-path on the replication job**

1. Click the **“Create multi-path”** in the operation menu of the replication job.

Physical disk											
RAID group											
Virtual disk											
Snapshot											
Logical unit											
QReplica											
	No.	VD name	Current owner	Target Name	Target IP						
OP	1	source	Controller 1	iqn.1997-05.tw.com.proware.proips-000902298:dev0.ctr1	192.168.15.1						

- Start
- Stop
- Refresh
- Create multi-path**
- Delete multi-path
- Schedule
- Delete

2. Enter the IP of iSCSI port on controller 2 of the target subsystem.

**QReplica - Select target IP**

IP :

3. Select the iSCSI node to log on and click **"Next"**.

QReplica - Get login information

**Choose authentication method.**

**No Authentication method**

CHAP

User : \_\_\_\_\_ (max: 223)

Secret : \_\_\_\_\_ (min: 12, max: 16)

**Select a target node**

	No.	Name
<input checked="" type="radio"/>	1	iqn.1997-05.tw.com.proware:proips-000902298:dev0.ctr2

Cancel      << Back    Next >>

4. Choose the same target VD and click **"Next"**.

QReplica - Select target LUN

	No.	LUN	VD name	Size(GB)	Vendor	Model	Serial	Revision
<input checked="" type="radio"/>	1	1	target	300	Proware	proIPS	2104001378902298	200

Cancel      << Back    Next >>

5. A new target will be added in this replication job as a redundancy path.

Physical disk    RAID group    Virtual disk    Snapshot    Logical unit <b>QReplica</b>										
	No.	VD name	Current owner	Target Name	Target IP	LUN	Name	Size(MB)	Size(G)	
<input type="button" value="OP"/>	1	source	Controller 1	iqn.1997-05.tw.com.proware:proips-000902298:dev0.ctr1	192.168.15.1	1	target	307200	300	
				iqn.1997-05.tw.com.proware:proips-000902298:dev0.ctr2	192.168.15.3	1				

Create    Configuration

- **Configure the replication job to run by schedule**

1. Click **“Schedule”** in the operation menu of the replication job.

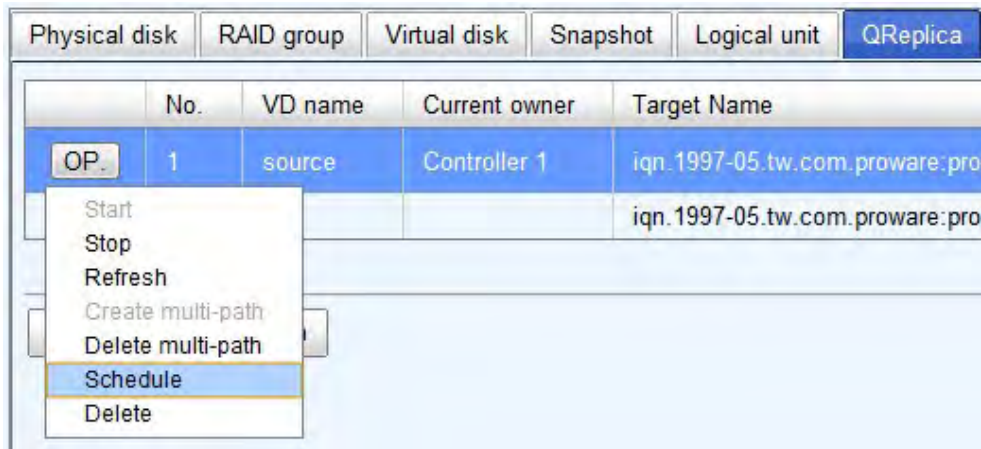

2. The replication job can be scheduled to run by day, by week or by month. The execution time can be configurable per user's need.

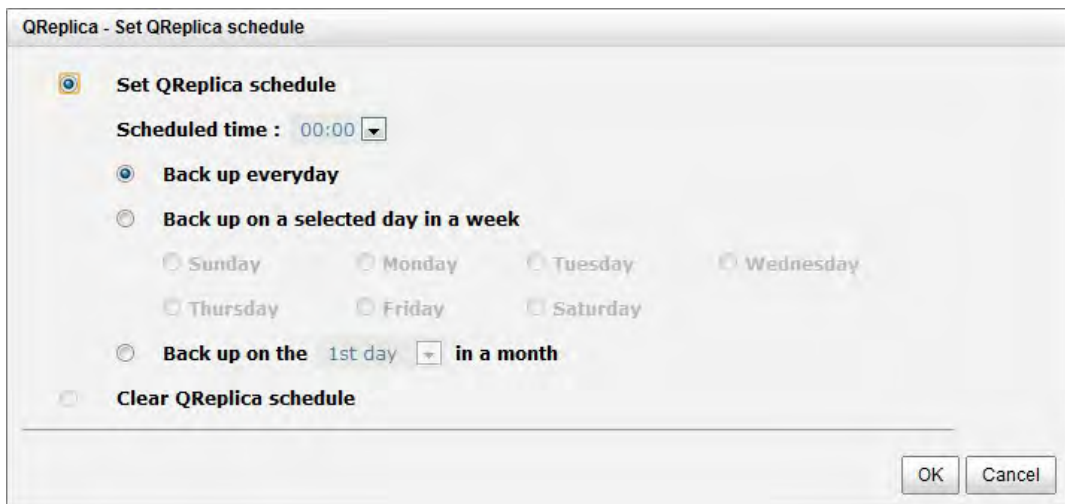

- **Configure the snapshot space**

The **QReplica** uses **Snapshot** help user to replicate the data without stop accessing to the source VD. If the snapshot space is not configured on the source VD in advance, the subsystem will allocate snapshot space for the source VD automatically when the replication job is created. The default snapshot space allocated by the subsystem is double size of the source VD. If the free space of the RG which the source VD resides in is less than double size of the source VD, the replication job will fail and pops up the error message.

To prevent this problem, user has to make sure the RG has enough free space for the snapshot space of source VD, or user has to configure the snapshot space of the source VD manually before the replication job is created.

1. To configure the snapshot space settings of QReplica, click the “**configuration**” button.



There are three settings in the **QReplica configuration** menu,

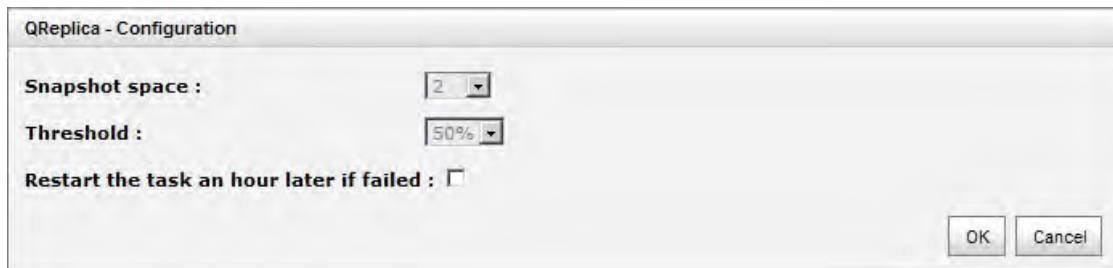

The **Snapshot space** specifies the ratio of snapshot space allocated to the source VD automatically when the snapshot space is not configured in advance. The default ratio is 2 to 1. It means when the replication job is creating, the subsystem will automatically use the free space of RG to create a snapshot space which size is double of the source VD.

The **Threshold** setting will monitor the utilization of snapshot space. When the used snapshot space achieves the threshold, the subsystem will automatically take a new snapshot and start the replication job. The purpose of threshold is to prevent the incremental copy fail immediately when running out of snapshot space. For example, the default threshold is 50%, and the system will check the snapshot space every hour. When the snapshot space is used over 50%, the subsystem will automatically replicate data from the source VD to the target VD. Next time, when the rest snapshot space has been used over 50%, in other words, the total snapshot space has been used over 75%, the subsystem will start the replication job again.

The **Restart the task an hour later if failed** setting is used when running out of snapshot space, the replication job will stop because there is no more available snapshot space. If this option has been checked, the subsystem will automatically clear the snapshots to release snapshot space, and the replication job will restart the task after an hour.



**IMPORTANT!** These two settings, *Threshold* and *Restart the task an hour later if failed*, will take effect only when the replication job is configured to run by schedule.

## Chapter 7 Troubleshooting

### 7.1 System Buzzer

The system buzzer features are listed below:

1. The system buzzer alarms 1 second when system boots up successfully.
2. The system buzzer alarms continuously when there is error occurred. The alarm will be stopped after error resolved or be muted.
3. The alarm will be muted automatically when the error is resolved. E.g., when RAID 5 is degraded and alarm rings immediately, user changes / adds one physical disk for rebuilding. When the rebuilding is done, the alarm will be muted automatically.

### 7.2 Event Notifications

- **PD events**

Level	Type	Description
<b>INFO</b>	PD inserted	Disk <slot> is inserted into system
<b>WARNING</b>	PD removed	Disk <slot> is removed from system
<b>ERROR</b>	HDD read error	Disk <slot> read block error
<b>ERROR</b>	HDD write error	Disk <slot> write block error
<b>ERROR</b>	HDD error	Disk <slot> is disabled
<b>ERROR</b>	HDD IO timeout	Disk <slot> gets no response
<b>INFO</b>	PD upgrade started	PD [<string>] starts upgrading firmware process.
<b>INFO</b>	PD upgrade finished	PD [<string>] finished upgrading firmware process.
<b>WARNING</b>	PD upgrade failed	PD [<string>] upgrade firmware failed.

- **HW events**

Level	Type	Description
<b>WARNING</b>	ECC single	Single-bit ECC error is detected at <address>
<b>ERROR</b>	ECC multiple	Multi-bit ECC error is detected at <address>
<b>INFO</b>	ECC dimm	ECC memory is installed
<b>INFO</b>	ECC none	Non-ECC memory is installed
<b>INFO</b>	SCSI bus reset	Received SCSI Bus Reset event at the SCSI Bus <number>
<b>ERROR</b>	SCSI host error	SCSI Host allocation failed
<b>ERROR</b>	SATA enable device fail	Failed to enable the SATA pci device
<b>ERROR</b>	SATA EDMA mem fail	Failed to allocate memory for SATA EDMA
<b>ERROR</b>	SATA remap mem fail	Failed to remap SATA memory io spcae



<b>ERROR</b>	SATA PRD mem fail	Failed to init SATA PRD memory manager
<b>ERROR</b>	SATA revision id fail	Failed to get SATA revision id
<b>ERROR</b>	SATA set reg fail	Failed to set SATA register
<b>ERROR</b>	SATA init fail	Core failed to initialize the SATA adapter
<b>ERROR</b>	SATA diag fail	SATA Adapter diagnostics failed
<b>ERROR</b>	Mode ID fail	SATA Mode ID failed
<b>ERROR</b>	SATA chip count error	SATA Chip count error
<b>INFO</b>	SAS port reply error	SAS HBA port <number> reply terminated abnormally
<b>INFO</b>	SAS unknown port reply error	SAS frontend reply terminated abnormally
<b>INFO</b>	FC port reply error	FC HBA port <number> reply terminated abnormally
<b>INFO</b>	FC unknown port reply error	FC frontend reply terminated abnormally

- **EMS events**

<b>Level</b>	<b>Type</b>	<b>Description</b>
<b>INFO</b>	Power install	Power(<string>) is installed
<b>ERROR</b>	Power absent	Power(<string>) is absent
<b>INFO</b>	Power restore	Power(<string>) is restored to work.
<b>ERROR</b>	Power fail	Power(<string>) is not functioning
<b>WARNING</b>	Power detect	PSU signal detection(<string>)
<b>INFO</b>	Fan restore	Fan(<string>) is restored to work.
<b>ERROR</b>	Fan fail	Fan(<string>) is not functioning
<b>INFO</b>	Fan install	Fan(<string>) is installed
<b>ERROR</b>	Fan not present	Fan(<string>) is not present
<b>ERROR</b>	Fan over speed	Fan(<string>) is over speed
<b>WARNING</b>	Thermal level 1	System temperature(<string>) is higher.
<b>ERROR</b>	Thermal level 2	System Overheated(<string>)!!!
<b>ERROR</b>	Thermal level 2 shutdown	System Overheated(<string>)!!! The system will auto-shutdown immediately.
<b>ERROR</b>	Thermal level 2 CTR shutdown	The controller will auto shutdown immediately, reason [ Overheated(<string>) ].
<b>WARNING</b>	Thermal ignore value	Unable to update thermal value on <string>
<b>WARNING</b>	Voltage level 1	System voltage(<string>) is higher/lower.
<b>ERROR</b>	Voltage level 2	System voltages(<string>) failed!!!
<b>ERROR</b>	Voltage level 2 shutdown	System voltages(<string>) failed!!! The system will auto-shutdown immediately.
<b>ERROR</b>	Voltage level 2 CTR shutdown	The controller will auto shutdown immediately, reason [ Voltage abnormal(<string>) ].
<b>INFO</b>	UPS OK	Successfully detect UPS
<b>WARNING</b>	UPS fail	Failed to detect UPS
<b>ERROR</b>	UPS AC loss	AC loss for system is detected
<b>ERROR</b>	UPS power low	UPS Power Low!!! The system will auto-shutdown immediately.
<b>WARNING</b>	SMART T.E.C.	Disk <slot> S.M.A.R.T. Threshold Exceed Condition occurred for attribute <string>
<b>WARNING</b>	SMART fail	Disk <slot>: Failure to get S.M.A.R.T information

<b>WARNING</b>	RedBoot failover	RedBoot failover event occurred
<b>WARNING</b>	Watchdog shutdown	Watchdog timeout shutdown occurred
<b>WARNING</b>	Watchdog reset	Watchdog timeout reset occurred

- **RMS events**

Level	Type	Description
<b>INFO</b>	Console Login	<username> login from <IP or serial console> via Console UI
<b>INFO</b>	Console Logout	<username> logout from <IP or serial console> via Console UI
<b>INFO</b>	Web Login	<username> login from <IP> via Web UI
<b>INFO</b>	Web Logout	<username> logout from <IP> via Web UI
<b>INFO</b>	Log clear	All event logs are cleared
<b>WARNING</b>	Send mail fail	Failed to send event to <email>.

- **LVM events**

Level	Type	Description
<b>INFO</b>	RG create OK	RG <name> has been created.
<b>INFO</b>	RG create fail	Failed to create RG <name>.
<b>INFO</b>	RG delete	RG <name> has been deleted.
<b>INFO</b>	RG rename	RG <name> has been renamed as <name>.
<b>INFO</b>	VD create OK	VD <name> has been created.
<b>INFO</b>	VD create fail	Failed to create VD <name>.
<b>INFO</b>	VD delete	VD <name> has been deleted.
<b>INFO</b>	VD rename	Name of VD <name> has been renamed to <name>.
<b>INFO</b>	VD read only	Cache policy of VD <name> has been set as read only.
<b>INFO</b>	VD write back	Cache policy of VD <name> has been set as write-back.
<b>INFO</b>	VD write through	Cache policy of VD <name> has been set as write-through.
<b>INFO</b>	VD extend	Size of VD <name> extends.
<b>INFO</b>	VD attach LUN OK	VD <name> has been LUN-attached.
<b>INFO</b>	VD attach LUN fail	Failed to attach LUN to VD <name>.
<b>INFO</b>	VD detach LUN OK	VD <name> has been detached.
<b>INFO</b>	VD detach LUN fail	Failed to attach LUN from bus <number>, SCSI ID <number>, lun <number>.
<b>INFO</b>	VD init started	VD <name> starts initialization.
<b>INFO</b>	VD init finished	VD <name> completes initialization.
<b>WARNING</b>	VD init failed	Failed to complete initialization of VD <name>.
<b>INFO</b>	VD rebuild started	VD <name> starts rebuilding.
<b>INFO</b>	VD rebuild finished	VD <name> completes rebuilding.
<b>WARNING</b>	VD rebuild failed	Failed to complete rebuild of VD <name>.
<b>INFO</b>	VD migrate started	VD <name> starts migration.
<b>INFO</b>	VD migrate finished	VD <name> completes migration.
<b>ERROR</b>	VD migrate failed	Failed to complete migration of VD <name>.
<b>INFO</b>	VD scrub started	Parity checking on VD <name> starts.



<b>INFO</b>	VD scrub finished	Parity checking on VD <name> completes with <address> parity/data inconsistency found.
<b>INFO</b>	VD scrub aborted	Parity checking on VD <name> stops with <address> parity/data inconsistency found.
<b>INFO</b>	RG migrate started	RG <name> starts migration.
<b>INFO</b>	RG migrate finished	RG <name> completes migration.
<b>INFO</b>	RG move started	RG <name> starts move.
<b>INFO</b>	RG move finished	RG <name> completes move.
<b>INFO</b>	VD move started	VD <name> starts move.
<b>INFO</b>	VD move finished	VD <name> completes move.
<b>ERROR</b>	VD move failed	Failed to complete move of VD <name>.
<b>INFO</b>	RG activated	RG <name> has been manually activated.
<b>INFO</b>	RG deactivated	RG <name> has been manually deactivated.
<b>INFO</b>	VD rewrite started	Rewrite at LBA <address> of VD <name> starts.
<b>INFO</b>	VD rewrite finished	Rewrite at LBA <address> of VD <name> completes.
<b>WARNING</b>	VD rewrite failed	Rewrite at LBA <address> of VD <name> failed.
<b>WARNING</b>	RG degraded	RG <name> is in degraded mode.
<b>WARNING</b>	VD degraded	VD <name> is in degraded mode.
<b>ERROR</b>	RG failed	RG <name> is failed.
<b>ERROR</b>	VD failed	VD <name> is failed.
<b>ERROR</b>	VD IO fault	I/O failure for stripe number <address> in VD <name>.
<b>WARNING</b>	Recoverable read error	Recoverable read error occurred at LBA <address>-<address> of VD <name>.
<b>WARNING</b>	Recoverable write error	Recoverable write error occurred at LBA <address>-<address> of VD <name>.
<b>ERROR</b>	Unrecoverable read error	Unrecoverable read error occurred at LBA <address>-<address> of VD <name>.
<b>ERROR</b>	Unrecoverable write error	Unrecoverable write error occurred at LBA <address>-<address> of VD <name>.
<b>ERROR</b>	Config read fail	Config read failed at LBA <address>-<address> of PD <slot>.
<b>ERROR</b>	Config write fail	Config write failed at LBA <address>-<address> of PD <slot>.
<b>ERROR</b>	CV boot error adjust global	Failed to change size of the global cache.
<b>INFO</b>	CV boot global	The global cache is ok.
<b>ERROR</b>	CV boot error create global	Failed to create the global cache.
<b>INFO</b>	PD dedicated spare	Assign PD <slot> to be the dedicated spare disk of RG <name>.
<b>INFO</b>	PD global spare	Assign PD <slot> to Global Spare Disks.
<b>WARNING</b>	PD read error	Read error occurred at LBA <address>-<address> of PD <slot>.
<b>WARNING</b>	PD write error	Write error occurred at LBA <address>-<address> of PD <slot>.
<b>WARNING</b>	Scrub wrong parity	The parity/data inconsistency is found at LBA <address>-<address> when checking parity on VD <name>.
<b>WARNING</b>	Scrub data recovered	The data at LBA <address>-<address> is recovered when checking parity on VD <name>.
<b>WARNING</b>	Scrub recovered data	A recoverable read error occurred at LBA <address>-<address> when checking parity on

		VD <name>.
<b>WARNING</b>	Scrub parity recovered	The parity at LBA <address>-<address> is regenerated when checking parity on VD <name>.
<b>INFO</b>	PD freed	PD <slot> has been freed from RG <name>.
<b>INFO</b>	RG imported	Configuration of RG <name> has been imported.
<b>INFO</b>	RG restored	Configuration of RG <name> has been restored.
<b>INFO</b>	VD restored	Configuration of VD <name> has been restored.
<b>INFO</b>	PD scrub started	PD <slot> starts disk scrubbing process.
<b>INFO</b>	Disk scrub finished	PD <slot> completed disk scrubbing process.
<b>INFO</b>	Large RG created	A large RG <name> with <number> disks included is created
<b>INFO</b>	Weak RG created	A RG <name> made up disks across <number> chassis is created
<b>INFO</b>	RG size shrunk	The total size of RG <name> shrunk
<b>INFO</b>	VD erase finished	VD <name> finished erasing process.
<b>WARNING</b>	VD erase failed	The erasing process of VD <name> failed.
<b>INFO</b>	VD erase started	VD <name> starts erasing process.

- **Snapshot events**

Level	Type	Description
<b>WARNING</b>	Snap mem	Failed to allocate snapshot memory for VD <name>.
<b>WARNING</b>	Snap space overflow	Failed to allocate snapshot space for VD <name>.
<b>WARNING</b>	Snap threshold	The snapshot space threshold of VD <name> has been reached.
<b>INFO</b>	Snap delete	The snapshot VD <name> has been deleted.
<b>INFO</b>	Snap auto delete	The oldest snapshot VD <name> has been deleted to obtain extra snapshot space.
<b>INFO</b>	Snap take	A snapshot on VD <name> has been taken.
<b>INFO</b>	Snap set space	Set the snapshot space of VD <name> to <number> MB.
<b>INFO</b>	Snap rollback started	Snapshot rollback of VD <name> has been started.
<b>INFO</b>	Snap rollback finished	Snapshot rollback of VD <name> has been finished.
<b>WARNING</b>	Snap quota reached	The quota assigned to snapshot <name> is reached.
<b>INFO</b>	Snap clear space	The snapshot space of VD <name> is cleared

- **iSCSI events**

Level	Type	Description
<b>INFO</b>	iSCSI login accepted	iSCSI login from <IP> succeeds.
<b>INFO</b>	iSCSI login rejected	iSCSI login from <IP> was rejected, reason [<string>]
<b>INFO</b>	iSCSI logout recvd	iSCSI logout from <IP> was received, reason [<string>].

- **Battery backup events**

Level	Type	Description
INFO	BBM start syncing	Abnormal shutdown detected, start flushing battery-backed data (<number> KB).
INFO	BBM stop syncing	Abnormal shutdown detected, flushing battery-backed data finished
INFO	BBM installed	Battery backup module is detected
INFO	BBM status good	Battery backup module is good
INFO	BBM status charging	Battery backup module is charging
WARNING	BBM status fail	Battery backup module is failed
INFO	BBM enabled	Battery backup feature is <string>.
INFO	BBM inserted	Battery backup module is inserted
INFO	BBM removed	Battery backup module is removed

- **JBOD events**

Level	Type	Description
INFO	PD upgrade started	JBOD <name> PD [<string>] starts upgrading firmware process.
INFO	PD upgrade finished	JBOD <name> PD [<string>] finished upgrading firmware process.
WARNING	PD upgrade failed	JBOD <name> PD [<string>] upgrade firmware failed.
INFO	PD freed	JBOD <name> PD <slot> has been freed from RG <name>.
INFO	PD inserted	JBOD <name> disk <slot> is inserted into system.
Warning	PD removed	JBOD <name> disk <slot> is removed from system.
ERROR	HDD read error	JBOD <name> disk <slot> read block error
ERROR	HDD write error	JBOD <name> disk <slot> write block error
ERROR	HDD error	JBOD <name> disk <slot> is disabled.
ERROR	HDD IO timeout	JBOD <name> disk <slot> gets no response
INFO	JBOD inserted	JBOD <name> is inserted into system
WARNING	JBOD removed	JBOD <name> is removed from system
WARNING	SMART T.E.C	JBOD <name> disk <slot>: S.M.A.R.T. Threshold Exceed Condition occurred for attribute <string>
WARNING	SMART fail	JBOD <name> disk <slot>: Failure to get S.M.A.R.T information
INFO	PD dedicated spare	Assign JBOD <name> PD <slot> to be the dedicated spare disk of RG <name>.
INFO	PD global spare	Assign JBOD <name> PD <slot> to Global Spare Disks.
ERROR	Config read fail	Config read error occurred at LBA <address>-<address> of JBOD <name> PD <slot>.
ERROR	Config write fail	Config write error occurred at LBA <address>-<address> of JBOD <name> PD <slot>.
WARNING	PD read error	Read error occurred at LBA <address>-<address> of JBOD <name> PD <slot>.
WARNING	PD write error	Write error occurred at LBA <address>-<address> of JBOD <name> PD <slot>.

<b>INFO</b>	PD scrub started	JBOD <name> PD <slot> starts disk scrubbing process.
<b>INFO</b>	PD scrub completed	JBOD <name> PD <slot> completed disk scrubbing process.
<b>WARNING</b>	PS fail	Power Supply of <string> in JBOD <name> is FAIL
<b>INFO</b>	PS normal	Power Supply of <string> in JBOD <name> is NORMAL
<b>WARNING</b>	FAN fail	Cooling fan of <string> in JBOD <name> is FAIL
<b>INFO</b>	FAN normal	Cooling fan of <string> in JBOD <name> is NORMAL
<b>WARNING</b>	Volt warn OV	Voltage of <string> read as <string> in JBOD <name> is WARN OVER
<b>WARNING</b>	Volt warn UV	Voltage of <string> read as <string> in JBOD <name> is WARN UNDER
<b>WARNING</b>	Volt crit OV	Voltage of <string> read as <string> in JBOD <name> is CRIT OVER
<b>WARNING</b>	Volt crit UV	Voltage of <string> read as <string> in JBOD <name> is CRIT UNDER
<b>INFO</b>	Volt recovery	Voltage of <string> in JBOD <string> is NORMAL
<b>WARNING</b>	Therm warn OT	Temperature of <string> read as <string> in JBOD <name> is OT WARNING
<b>WARNING</b>	Therm warn UT	Temperature of <string> read as <string> in JBOD <name> is UT WARNING
<b>WARNING</b>	Therm fail OT	Temperature of <string> read as <string> in JBOD <name> is OT FAILURE
<b>WARNING</b>	Therm fail UT	Temperature of <string> read as <string> in JBOD <name> is UT FAILURE
<b>INFO</b>	Therm recovery	Temperature of <string> in JBOD <name> is NORMAL

- **System maintenance events**

Level	Type	Description
<b>INFO</b>	System shutdown	System shutdown.
<b>INFO</b>	System reboot	System reboot.
<b>INFO</b>	System console shutdown	System shutdown from <string> via Console UI
<b>INFO</b>	System web shutdown	System shutdown from <string> via Web UI
<b>INFO</b>	System button shutdown	System shutdown via power button
<b>INFO</b>	System LCM shutdown	System shutdown via LCM
<b>INFO</b>	System console reboot	System reboot from <string> via Console UI
<b>INFO</b>	System web reboot	System reboot from <string> via Web UI
<b>INFO</b>	System LCM reboot	System reboot via LCM
<b>INFO</b>	FW upgrade start	System firmware upgrade starts.
<b>INFO</b>	FW upgrade success	System firmware upgrade succeeds.
<b>WARNING</b>	FW upgrade failure	System firmware upgrade is failed.

<b>ERROR</b>	IPC FW upgrade timeout	System firmware upgrade timeout on another controller
<b>INFO</b>	Config imported	<string> config imported

- **HAC events**

Level	Type	Description
<b>INFO</b>	RG owner changed	The preferred owner of RG <name> has been changed to controller <number>.
<b>INFO</b>	Force CTR write through	Controller <number> forced to adopt write-through mode on failover.
<b>INFO</b>	Restore CTR cache mode	Controller <number> restored to previous caching mode on failback.
<b>INFO</b>	Failover complete	All volumes in controller <number> completed failover process.
<b>INFO</b>	Failback complete	All volumes in controller <number> completed failback process.
<b>INFO</b>	CTR inserted	Controller <number> is inserted into system
<b>ERROR</b>	CTR removed	Controller <number> is removed from system
<b>ERROR</b>	CTR timeout	Controller <number> gets no response
<b>ERROR</b>	CTR lockdown	Controller <number> is locked down
<b>ERROR</b>	CTR memory NG	Memory size mismatch
<b>ERROR</b>	CTR firmware NG	Firmware version mismatch
<b>ERROR</b>	CTR lowspeed NG	Low speed inter link is down
<b>ERROR</b>	CTR highspeed NG	High speed inter link is down
<b>ERROR</b>	CTR backend NG	SAS expander is down
<b>ERROR</b>	CTR frontend NG	FC IO controller is down
<b>INFO</b>	CTR reboot FW sync	Controller reboot, reason [Firmware synchronization completed]

- **Clone events**

Level	Type	Description
<b>INFO</b>	VD clone started	VD <name> starts cloning process.
<b>INFO</b>	VD clone finished	VD <name> finished cloning process.
<b>WARNING</b>	VD clone failed	The cloning in VD <name> failed.
<b>INFO</b>	VD clone aborted	The cloning in VD <name> was aborted.
<b>INFO</b>	VD clone set	The clone of VD <name> has been designated.
<b>INFO</b>	VD clone reset	The clone of VD <name> is no longer designated.
<b>WARNING</b>	Auto clone error	Auto clone task: <string>.
<b>WARNING</b>	Auto clone no snap	Auto clone task: Snapshot <name> is not found for VD <name>.

## Appendix

### A. Certification list

- **iSCSI Initiator (Software)**

OS	Software/Release Number
Microsoft Windows	Microsoft iSCSI Software Initiator Release v2.08  System Requirements: 1. Windows 2000 Server with SP4 2. Windows Server 2003 with SP2 3. Windows Server 2008 with SP2
Linux	The iSCSI Initiators are different for different Linux Kernels.  1. For Red Hat Enterprise Linux 3 (Kernel 2.4), install linux-iscsi-3.6.3.tar 2. For Red Hat Enterprise Linux 4 (Kernel 2.6), use the build-in iSCSI initiator iscsi-initiator-utils-4.0.3.0-4 in kernel 2.6.9 3. For Red Hat Enterprise Linux 5 (Kernel 2.6), use the build-in iSCSI initiator iscsi-initiator-utils-6.2.0.742-0.5.el5 in kernel 2.6.18
Mac	ATTO Xtend SAN iSCSI initiator v3.10  System Requirements: 1. Mac OS X v10.5 or later

For ATTO Xtend SAN iSCSI initiator, it is not free. Please contact your local distributor.

- **10GbE iSCSI HBA card**

Vendor	Model
Chelsio	S310E-CR-C 10GbE Storage Accelerator (PCI-Express 8x, 10GbE, 1 port, SFP+)

- **10GbE NIC**

Vendor	Model
Intel	E10G42AFDA 10 Gigabit AF DA (Intel 82598EB 10GbE controller, PCI-Express 8x, 10GbE, 2 ports, SFP+)
Intel	E10G42BFSR Ethernet Server Adapter X520-SR2 (Intel 82599ES 10GbE controller, PCI-Express 8x, 10GbE, 2 ports, LC Fiber Optic)
Intel	EXPX9502CX4 10 Gigabit CX4 (Intel 82598EB 10GbE controller, PCI-Express 8x, 10 GbE, 2 ports, CX4)

- **10GbE GBIC**

Vendor	Model
Avago	AFBR-703SDZ (10 Gb/s SFP transceiver, 850nm)
Finisar	FTLX8571D3BCV (10 Gb/s SFP transceiver, 850nm)

- **10GbE Switch**

Vendor	Model
Dell	PowerConnect 8024F (24x SFP+ 10Gb with 4x Combo Ports of 10GBASE-T)
HP	ProCurve 2910al-24G J9145A (4x 10GbE J9149A CX4 Ports, 24x 10/100/1000 Ports)
BLADE	RackSwitch G8124 10G (24 x SFP+ 10Gbps Ports)

- **Hard drive**

SAS drives are recommended on dual controller system. For SATA drivers, QSATA boards are required.

### SAS 3.5"

Vendor	Model
Hitachi	Ultrastar 15K147, HUS151436VLS300, 36GB, 15000RPM, SAS 3.0Gb/s, 16M
Hitachi	Ultrastar 15K300, HUS153073VLS300, 73GB, 15000RPM, SAS 3.0Gb/s, 16M (F/W: A410)
Seagate	Cheetah 15K.4, ST336754SS, 36.7GB, 15000RPM, SAS 3.0Gb/s, 8M
Seagate	Cheetah 15K.5, ST373455SS, 73.4GB, 15000RPM, SAS 3.0Gb/s, 16M
Seagate	Cheetah 15K.5, ST3146855SS, 146.8GB, 15000RPM, SAS 3.0Gb/s, 16M
Seagate	Cheetah 15K.6, ST3450856SS, 450GB, 15000RPM, SAS 3.0Gb/s, 16M (F/W: 003)
Seagate	Cheetah NS, ST3400755SS, 400GB, 10000RPM, SAS 3.0Gb/s, 16M
Seagate	Barracuda ES.2, ST31000640SS, 1TB, 7200RPM, SAS 3.0Gb/s, 16M (F/W: 0002)
Seagate	Cheetah NS.2, ST3600002SS, 600GB, 10000RPM, SAS 2.0, 6.0Gb/s, 16M (F/W: 0004)
Seagate	Cheetah 15K.7, ST3600057SS, 600GB, 15000RPM, SAS 2.0, 6.0Gb/s, 16MB (F/W: 0004)
Seagate	Constellation ES, ST31000424SS, 1TB, 7200RPM, SAS 2.0 6.0Gb/s, 16MB (F/W: 0005)
Seagate	Constellation ES, ST32000444SS, 2TB, 7200RPM, SAS 2.0 6.0Gb/s, 16MB (F/W: 0005)

### SAS 2.5"

Vendor	Model



Seagate	Savvio 10K.3, ST9300603SS, 300GB, 10000RPM, SAS 2.0, 6.0Gb/s, 16M (F/W: 0003)
Seagate	Savvio 15K.2, ST9146852SS, 147GB, 15000RPM, SAS 2.0, 6.0Gb/s, 16M (F/W: 0002)
Seagate	Constellation, ST9500430SS, 500GB, 7200RPM, SAS 2.0, 6.0Gb/s, 16M (F/W: 0001)

**SATA 3.5"**

Vendor	Model
Hitachi	Deskstar 7K250, HDS722580VLSA80, 80GB, 7200RPM, SATA, 8M
Hitachi	Deskstar E7K500, HDS725050KLA360, 500GB, 7200RPM, SATA II, 16M
Hitachi	Deskstar 7K80, HDS728040PLA320, 40GB, 7200RPM, SATA II, 2M
Hitachi	Deskstar T7K500, HDT725032VLA360, 320GB, 7200RPM, SATA II, 16M
Hitachi	Deskstar P7K500, HDP725050GLA360, 500GB, 7200RPM, SATA II, 16M (F/W: K2A0AD1A)
Hitachi	Deskstar E7K1000, HDE721010SLA330, 1TB, 7200RPM, SATA 3.0Gb/s, 32MB, NCQ (F/W: ST60A3AA)
Hitachi	UltraStar A7K2000, HUA722020ALA330, 2TB, 7200RPM, SATA 3.0Gb/s, 32MB, NCQ (F/W: JKAOA20N)
Maxtor	DiamondMax Plus 9, 6Y080M0, 80GB, 7200RPM, SATA, 8M
Maxtor	DiamondMax 11, 6H500F0, 500GB, 7200RPM, SATA 3.0Gb/s, 16M
Samsung	SpinPoint P80, HDSASP0812C, 80GB, 7200RPM, SATA, 8M
Seagate	Barracuda 7200.7, ST380013AS, 80GB, 7200RPM, SATA 1.5Gb/s, 8M
Seagate	Barracuda 7200.7, ST380817AS, 80GB, 7200RPM, SATA 1.5Gb/s, 8M, NCQ
Seagate	Barracuda 7200.8, ST3400832AS, 400GB, 7200RPM, SATA 1.5Gb/s, 8M, NCQ
Seagate	Barracuda 7200.9, ST3500641AS, 500GB, 7200RPM, SATA 3.0Gb/s, 16M, NCQ
Seagate	Barracuda 7200.11, ST3500320AS, 500GB, 7200RPM, SATA 3.0Gb/s, 32M, NCQ
Seagate	Barracuda 7200.11, ST31000340AS, 1TB, 7200RPM, SATA 3.0Gb/s, 32M, NCQ
Seagate	Barracuda 7200.11, ST31500341AS, 1.5TB, 7200RPM, SATA 3.0Gb/s, 32M, NCQ (F/W: SD17)
Seagate	NL35.2, ST3400633NS, 400GB, 7200RPM, SATA 3.0Gb/s, 16M
Seagate	NL35.2, ST3500641NS, 500GB, 7200RPM, SATA 3.0Gb/s, 16M
Seagate	Barracuda ES, ST3500630NS, 500GB, 7200RPM, SATA 3.0Gb/s, 16M
Seagate	Barracuda ES, ST3750640NS, 750GB, 7200RPM, SATA 3.0Gb/s, 16M
Seagate	Barracuda ES.2, ST31000340NS, 1TB, 7200RPM, SATA 3.0Gb/s, 32M (F/W: SN06)
Seagate	SV35.5, ST3500410SV, 500GB, 7200 RPM, SATA 3.0Gb/s, 16M, NCQ (F/W: CV11)
Seagate	Constellation ES, ST31000524NS, 1TB, 7200RPM, SATA 3.0Gb/s, 32M, NCQ (F/W: SN11)
Western Digital	Caviar SE, WD800JD, 80GB, 7200RPM, SATA 3.0Gb/s, 8M
Western Digital	Caviar SE, WD1600JD, 160GB, 7200RPM, SATA 1.5G/s, 8M
Western Digital	Caviar RE2, WD4000YR, 400GB, 7200RPM, SATA 1.5Gb/s, 16M, NCQ
Western Digital	Caviar RE16, WD5000AAKS, 500GB, 7200RPM, SATA 3.0Gb/s, 16M
Western Digital	RE2, WD4000YS, 400GB, 7200RPM, SATA 3.0Gb/s, 16M
Western Digital	RE2, WD5000ABYS, 500GB, 7200RPM, SATA 3.0Gb/s, 16M, NCQ
Western Digital	RE2-GP, WD1000FYPS, 1TB, 7200RPM, SATA 3.0Gb/s, 16M
Western Digital	RE3, WD1002FBYS, 1000GB, 7200RPM, SATA 3.0Gb/s, 32M, NCQ



	(F/W: 03.00C05)
Western Digital	RE4, WD2002FYPS, 2TB, IntelliPower, SATA 3.0Gb/s, 64M, NCQ (F/W: 04.05G04)
Western Digital	RE4-GP, WD2002FYPS, 2TB, IntelliPower, SATA 3.0Gb/s, 64M, NCQ (F/W: 04.01G01)
Western Digital	RE4, WD2003FYYS, 2TB, 7200RPM, SATA 3.0Gb/s, 64M, NCQ (F/W: 01.01D01)
Western Digital	RE4, WD1003FBYX, 1TB, 7200RPM, SATA 3.0Gb/s, 64M, NCQ (F/W: 01.01V01)
Western Digital	RE4, WD5003ABYX, 500GB, 7200RPM, SATA 3.0Gb/s, 64M, NCQ (F/W: 01.01S01)
Western Digital	Raptor, WD360GD, 36.7GB, 10000RPM, SATA 1.5Gb/s, 8M
Western Digital	VelcoiRaptor, WD3000HLFS, 300GB, 10000RPM, SATA 3.0Gb/s, 16M (F/W: 04.04V01)

**SATA 2.5"**

<b>Vendor</b>	<b>Model</b>
Seagate	Constellation, ST9500530NS, 500GB, 7200RPM, SATA 3.0Gb/s, 32M (F/W: SN02)

## B. Microsoft iSCSI initiator

Here is the step by step to setup Microsoft iSCSI Initiator. Please visit Microsoft website for latest iSCSI initiator. This example is based on Microsoft Windows Server 2008 R2.

- **Connect**

1. Run Microsoft iSCSI Initiator.
2. Input IP address or DNS name of the target. And then click **“Quick Connect”**.

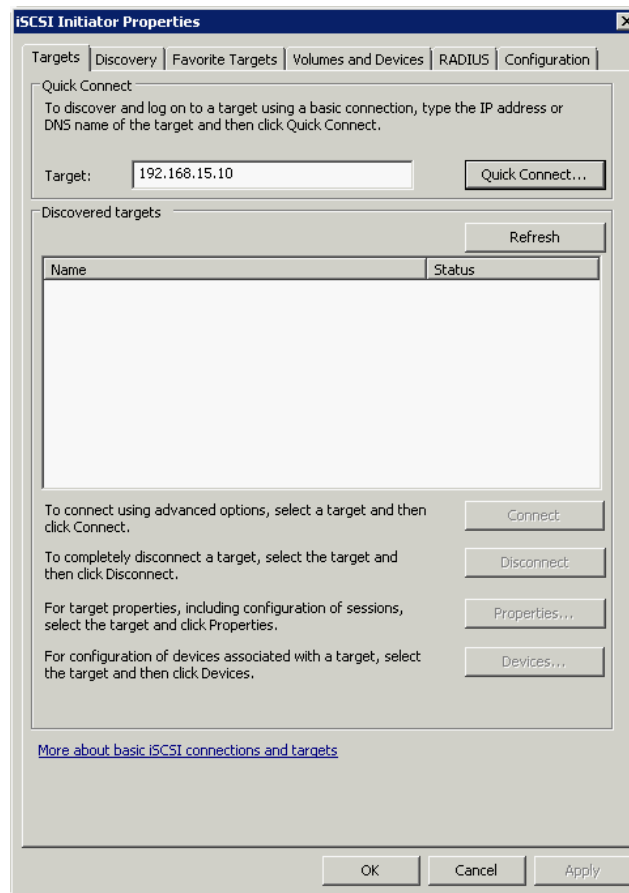

3. Click **“Done”**.

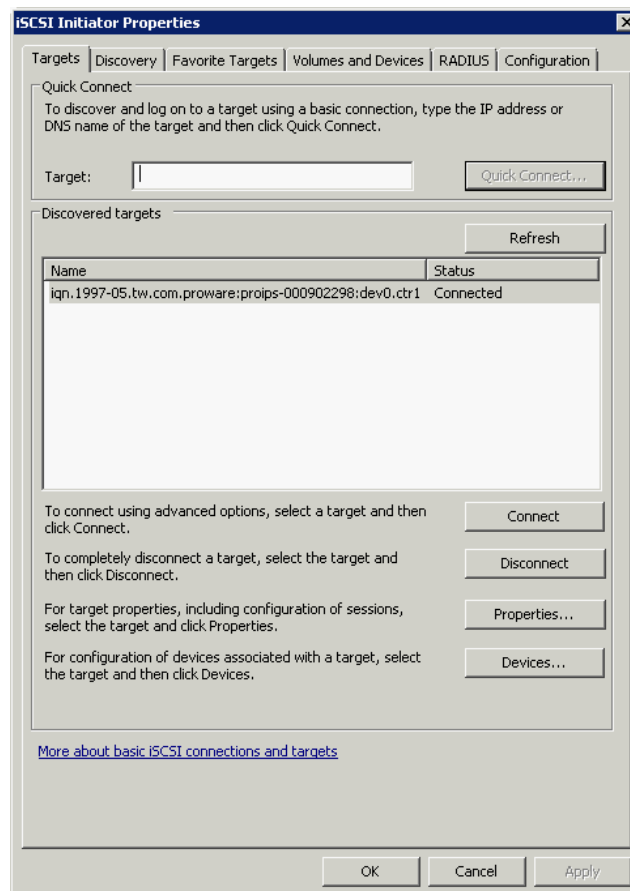
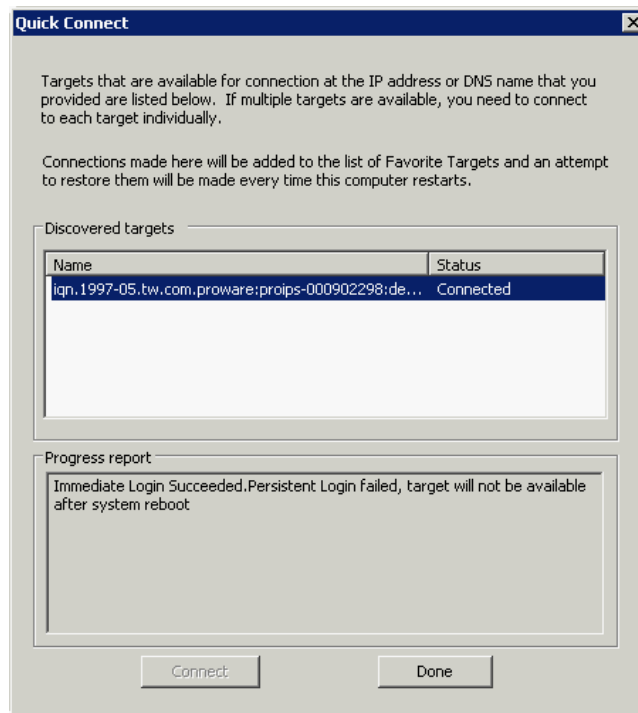

4. It can connect to an iSCSI disk now.

- **MPIO Service**

5. Please run "Server Manager" with below path:

**Control Panel\System and Security\Administrative Tools**

6. Click "**Feature**" and select **Add Features**.

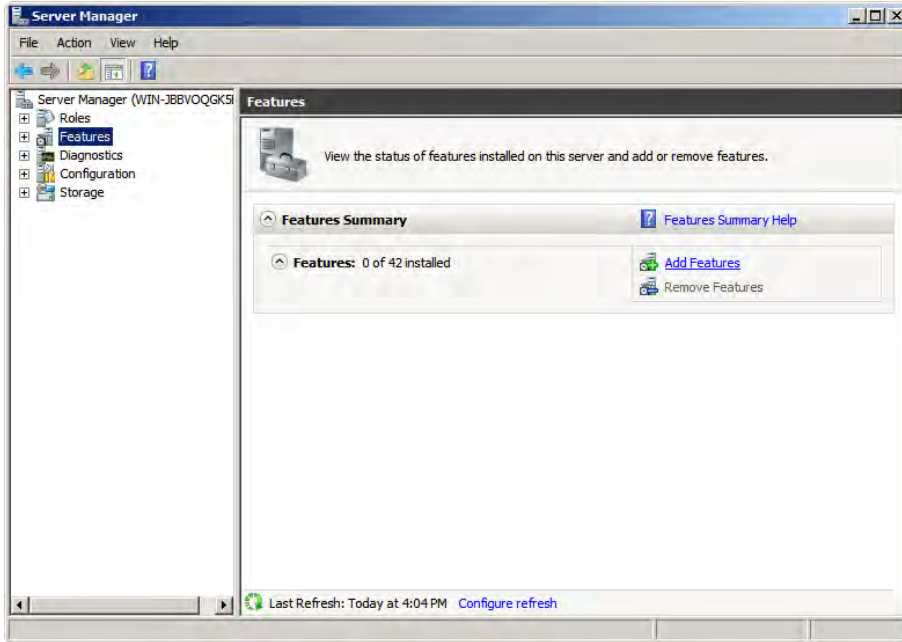

7. Please choose the checkbox of Multipath I/O

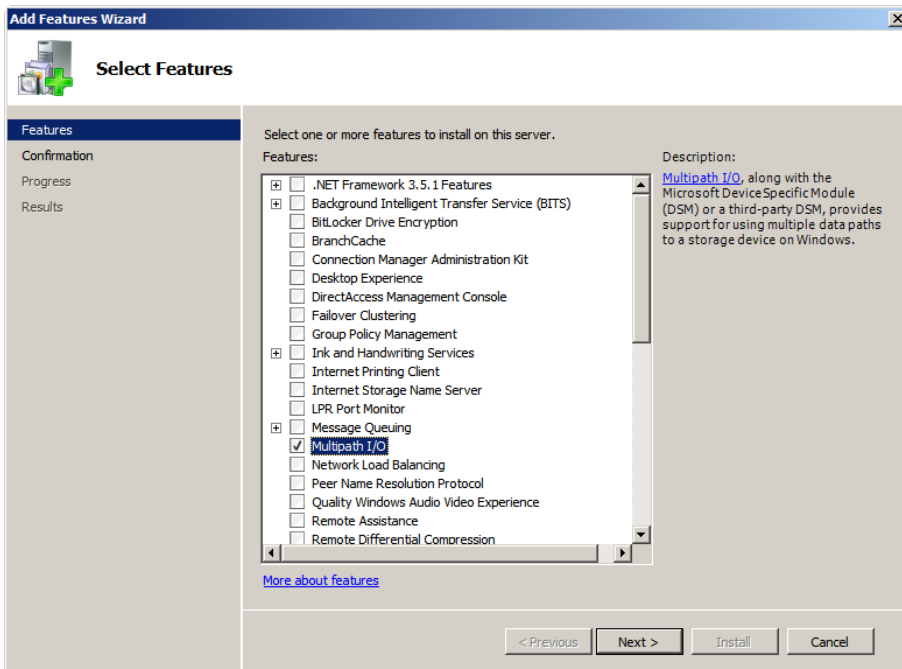

## 8. Install:

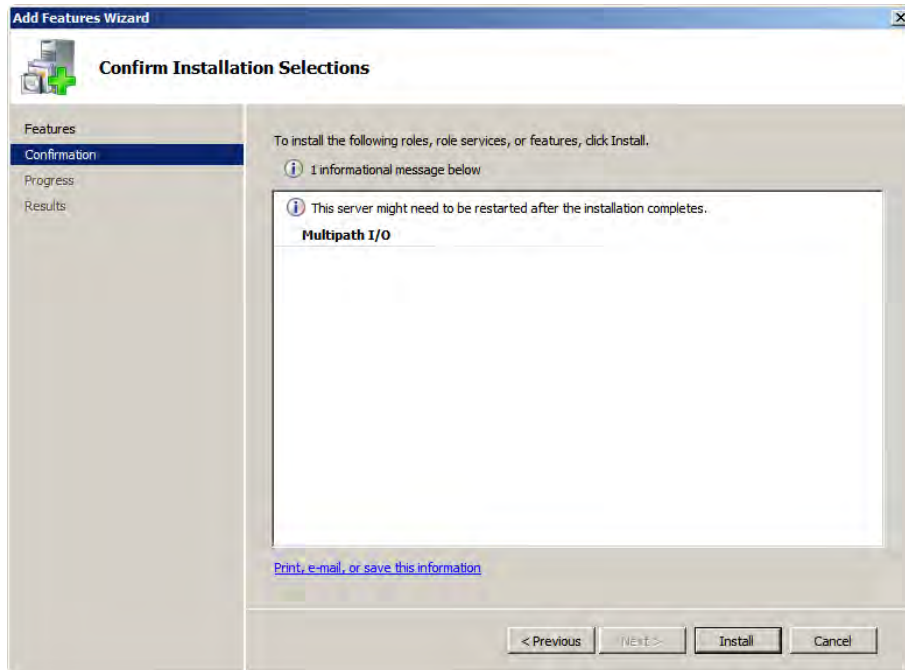

## 9. Installation succeeded.

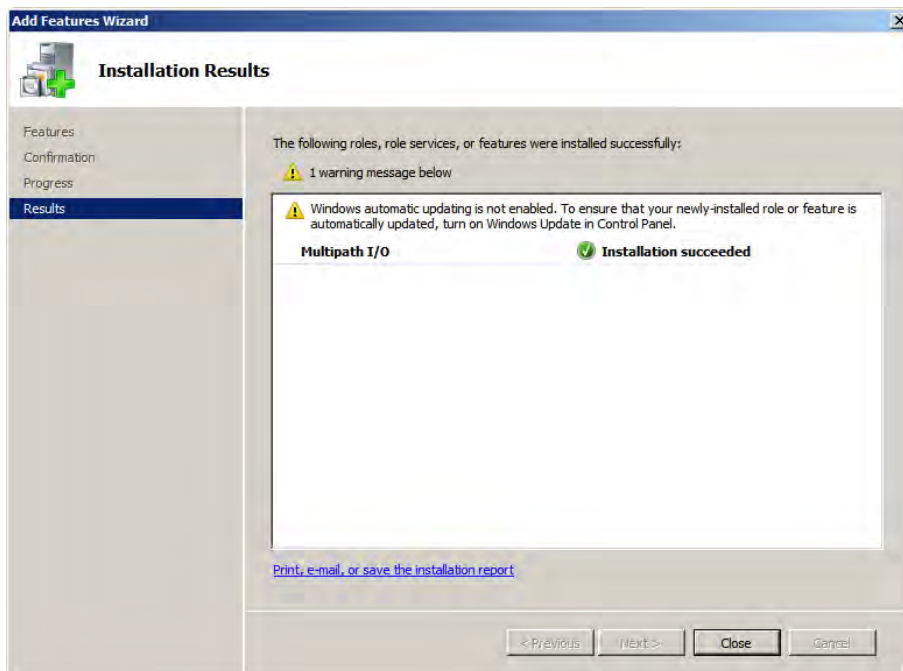

- **Starting iSCSI Initiator**

10. Please run “iSCSI initiator” with below path:

**Control Panel\System and Security\Administrative Tools**

11. Click → **Discovery tab** → **Discover Portal**

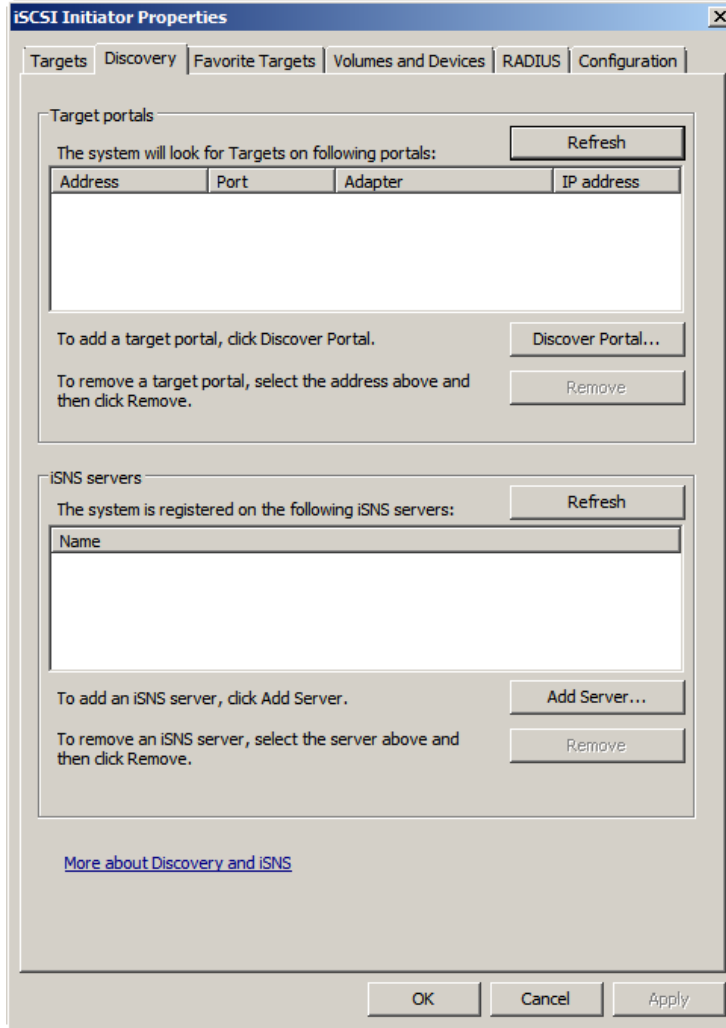

12. Input the IP address of controller1

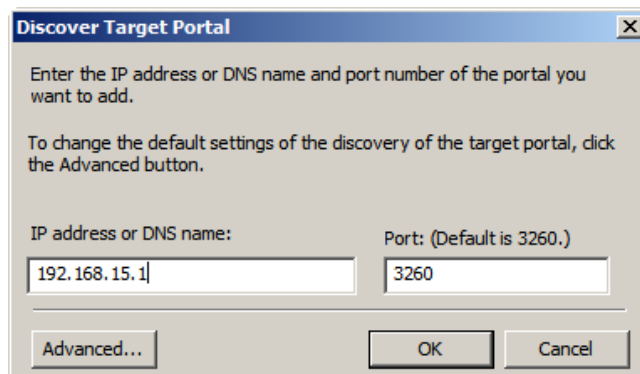

### 13. Click **Discover Portal**

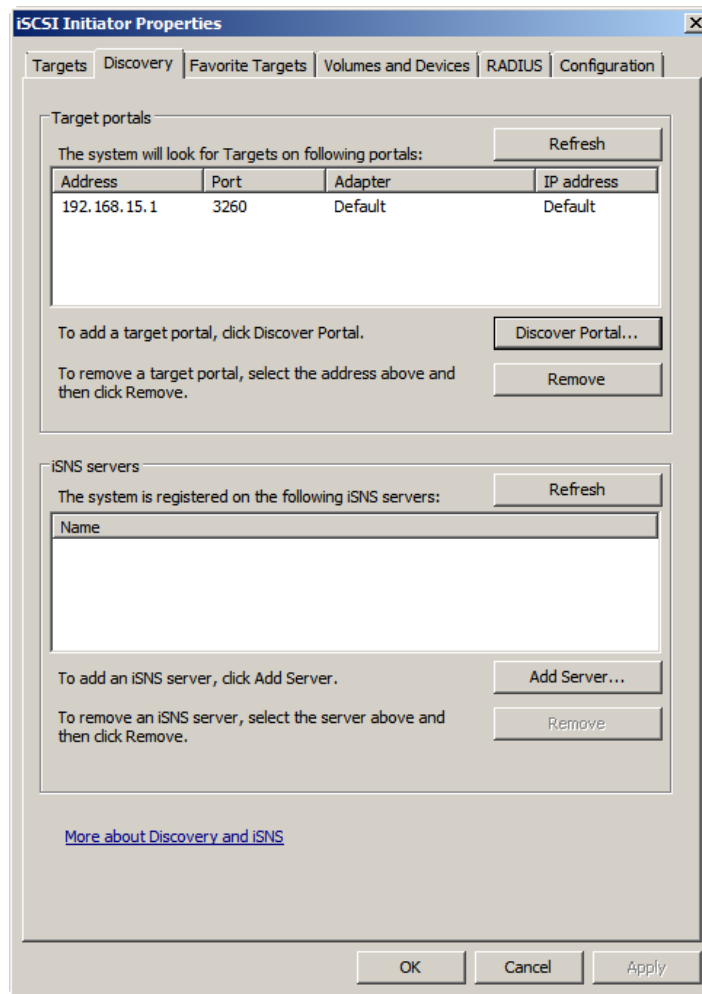

### 14. Input IP address of controller2

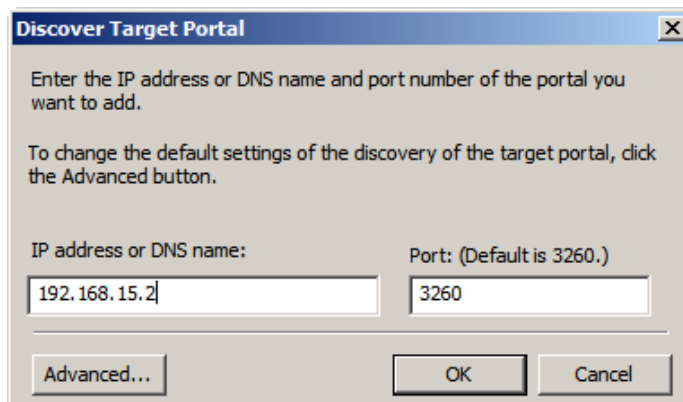

15. Please connect ctrl1

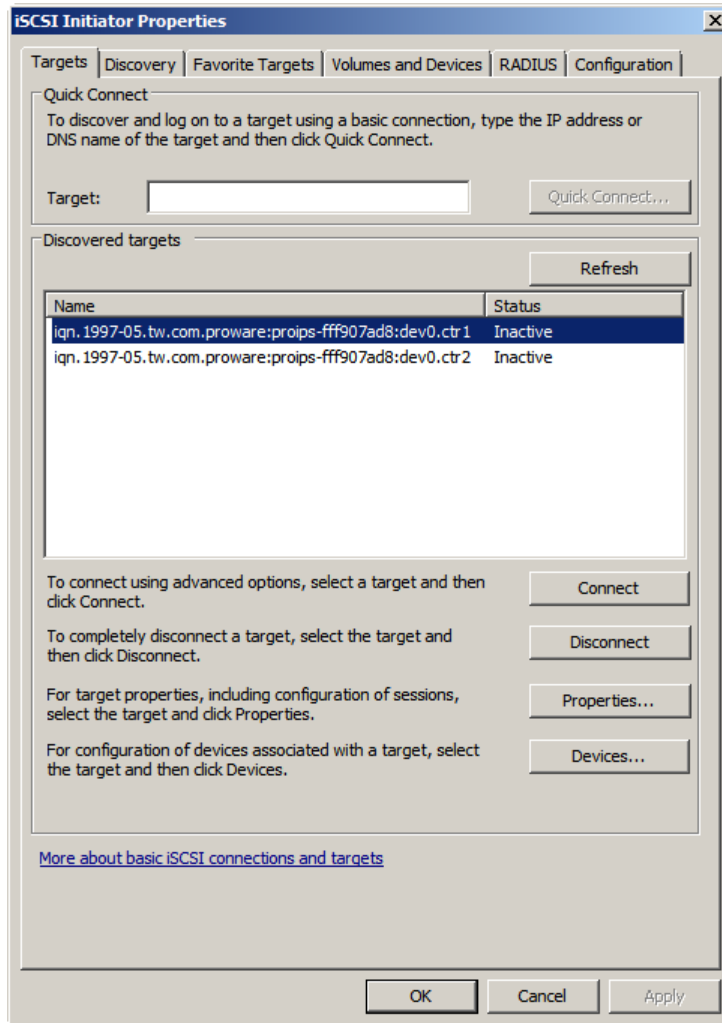

16. Choose checkbox of "Enable multipath-path"

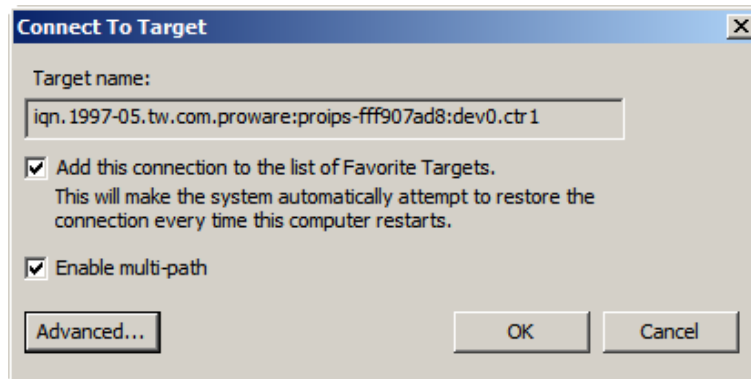



17. Please select the IP address for Initiator & Target of controller1

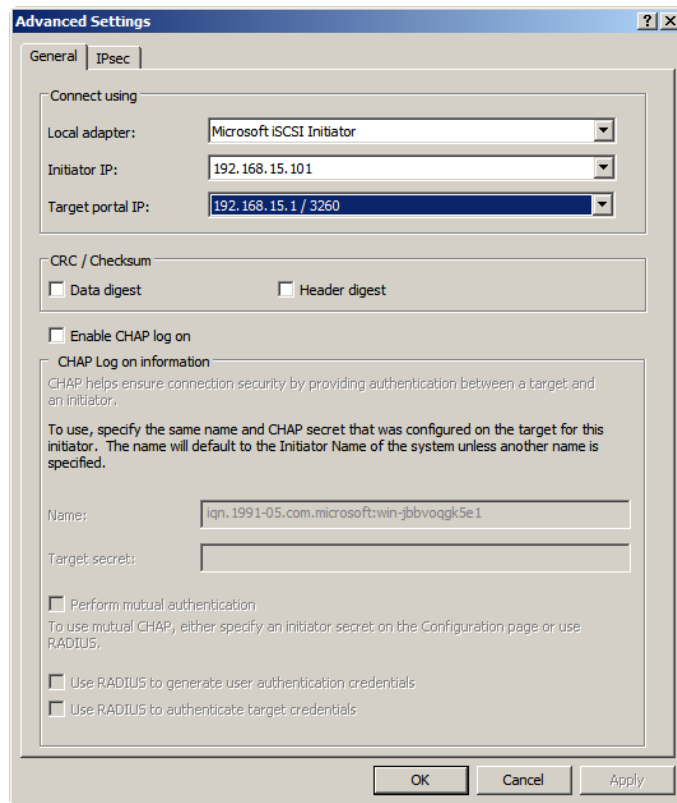

18. Please connect ctrl2.

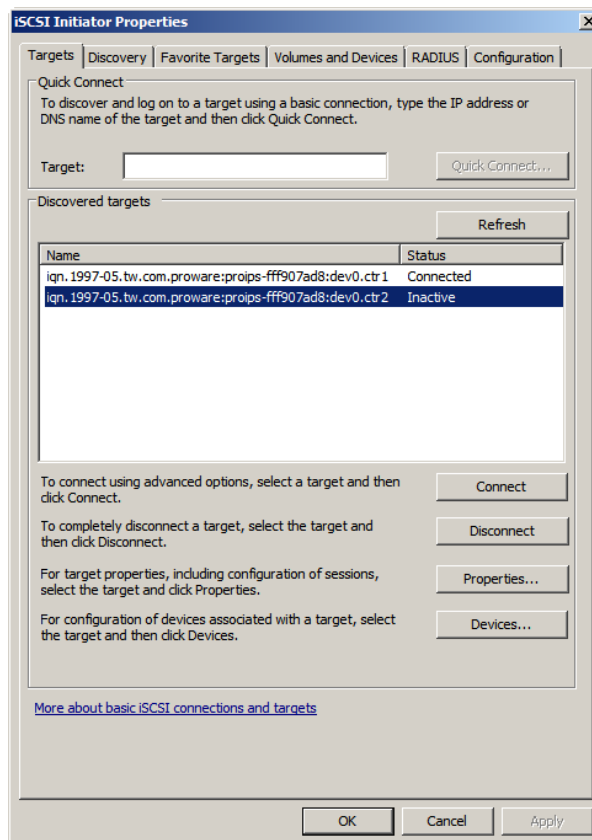

19. Choose checkbox of “**Enable multipath-path**”.

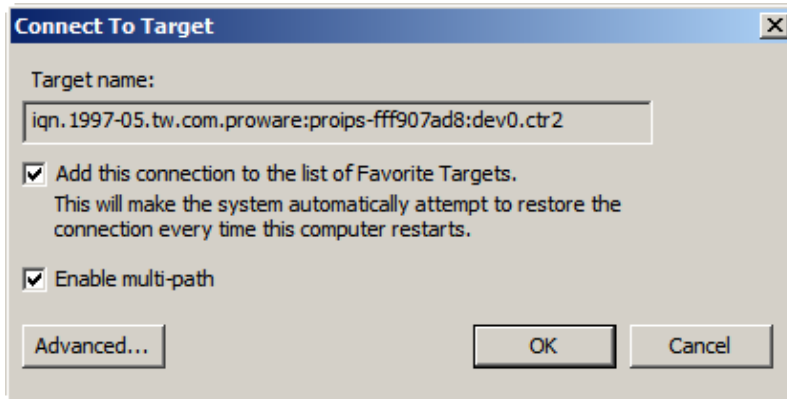

20. Please select the IP address for Initiator & Target of controller2.

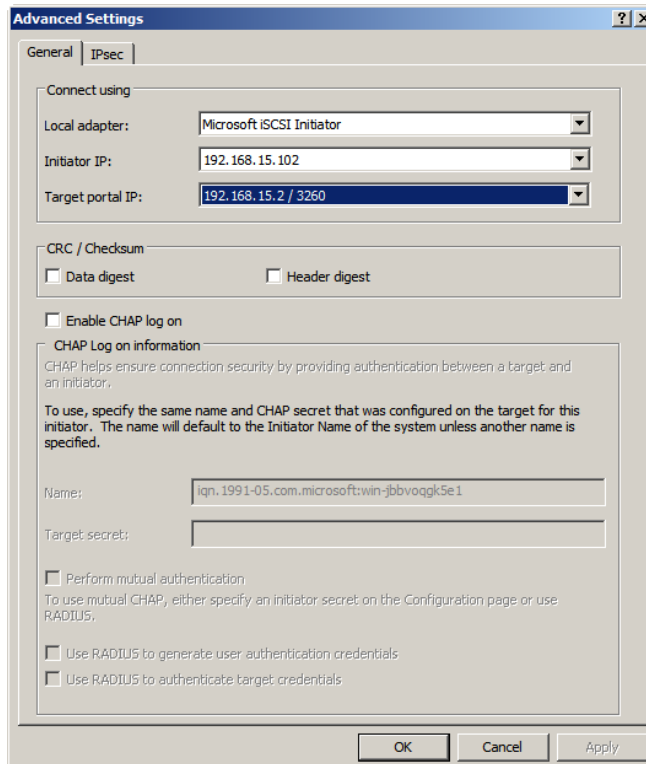

## 21. iSCSI initiator install finish.

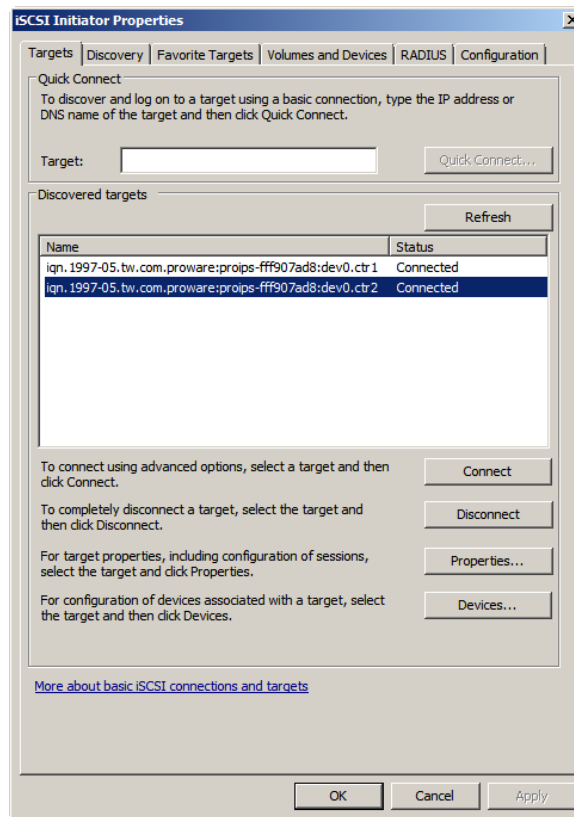

- **Setup MPIO**

22. Please run "MPIO" with below path:

**Control Panel\System and Security\Administrative Tools**

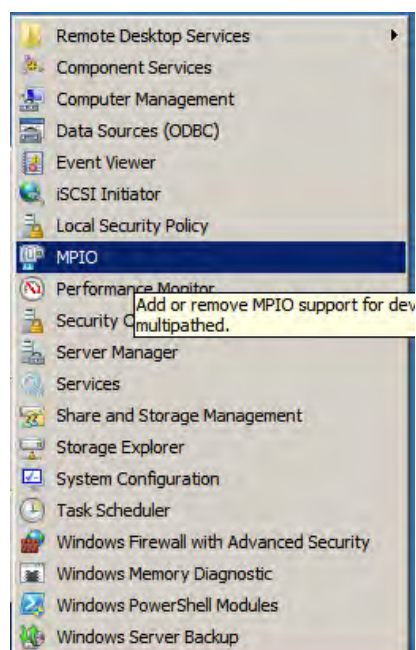

23. Click tab of **"Discover Multi-Paths"**
24. Choose checkbox of **"Add support for iSCSI devices"**

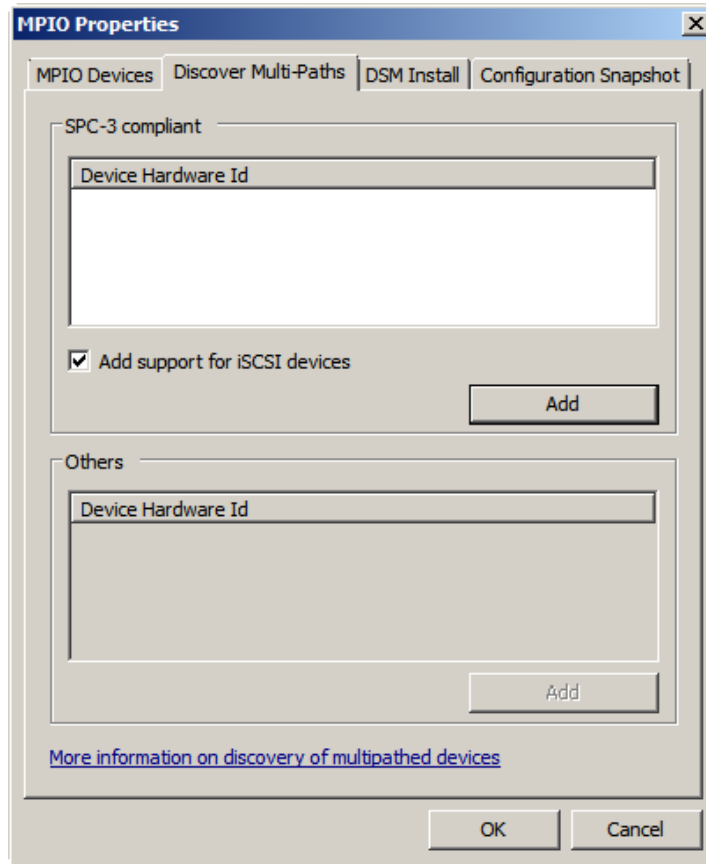

25. Reboot

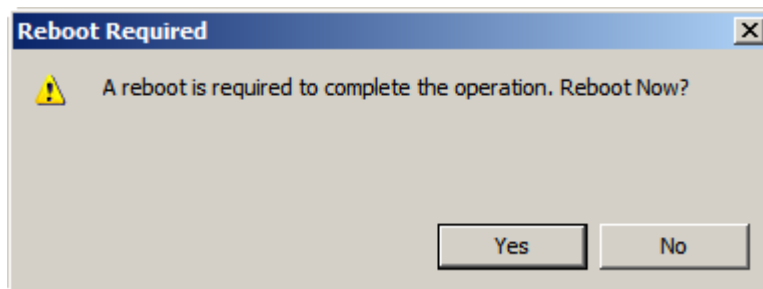

- **MC/S**

26. If running MC/S, please continue.
27. Select one target name, click **“Properties...”**.
28. Click **“MCS...”** to add additional connections.

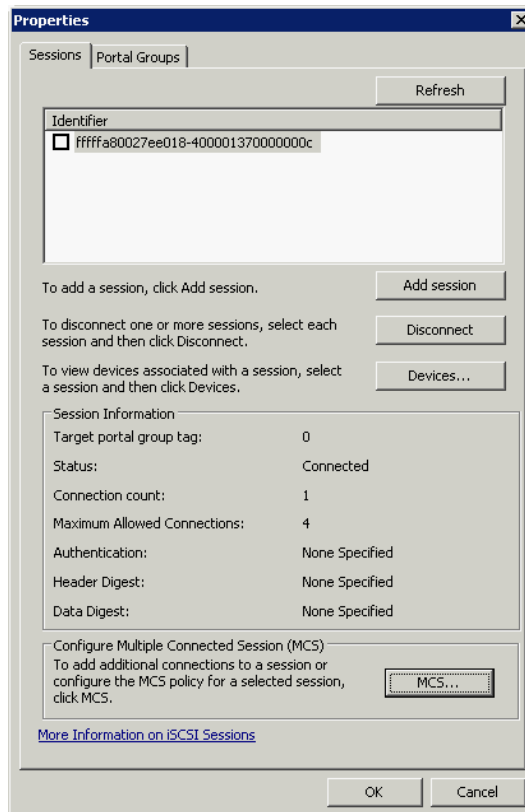
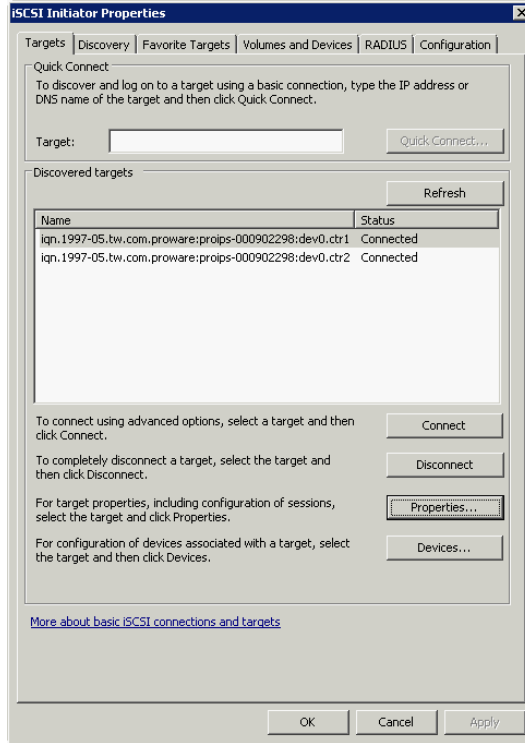

29. Click **"Add..."**.
30. Click **"Advanced..."**.

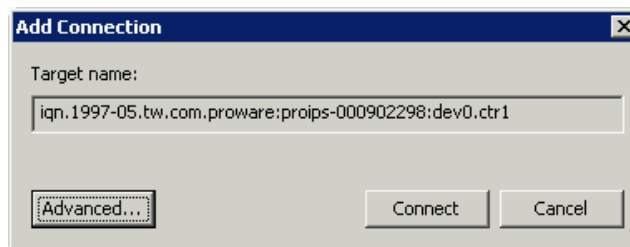
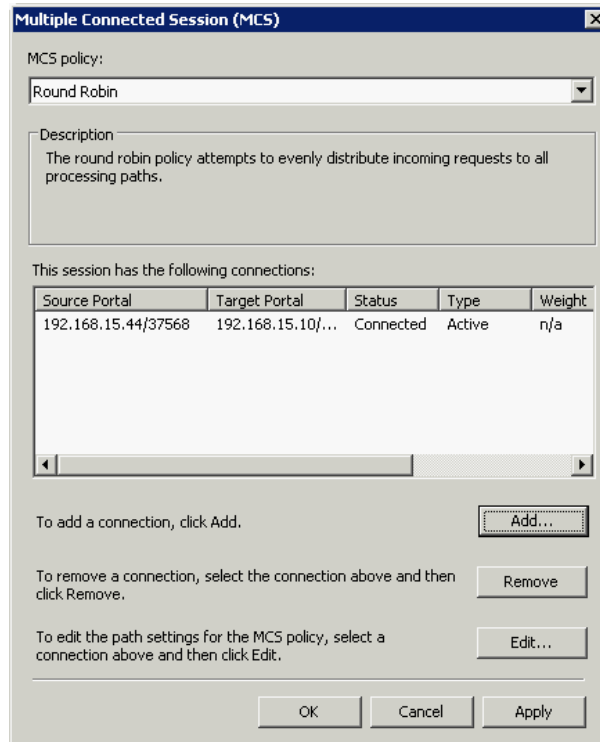

31. Select Initiator IP and Target portal IP, and then click **"OK"**.
32. Click **"Connect"**.
33. Click **"OK"**.

**Advanced Settings**

General | IPsec

Connect using

Local adapter: Microsoft iSCSI Initiator

Initiator IP: 192.168.16.45

Target portal IP: 192.168.16.11 / 3260

CRC / Checksum

Data digest       Header digest

Enable CHAP log on

CHAP Log on information

CHAP helps ensure connection security by providing authentication between a target and an initiator.

To use, specify the same name and CHAP secret that was configured on the target for this initiator. The name will default to the Initiator Name of the system unless another name is specified.

Name: 44

Target secret:

Perform mutual authentication  
To use mutual CHAP, either specify an initiator secret on the Configuration page or use RADIUS.

Use RADIUS to generate user authentication credentials

Use RADIUS to authenticate target credentials

OK    Cancel    Apply

**Multiple Connected Session (MCS)**

MCS policy:

Round Robin

Description

The round robin policy attempts to evenly distribute incoming requests to all processing paths.

This session has the following connections:

Source Portal	Target Portal	Status	Type	Weight	C
192.168.15.44/...	192.168.15.10/...	Connected	Active	n/a	0
192.168.16.44/...	192.168.16.11/...	Connected	Active	n/a	0

To add a connection, click Add.

Add...

To remove a connection, select the connection above and then click Remove.

Remove

To edit the path settings for the MCS policy, select a connection above and then click Edit.

Edit...

OK    Cancel    Apply

34. Done.

- **Disconnect**

35. Select the target name, click **“Disconnect”**, and then click **“Yes”**.

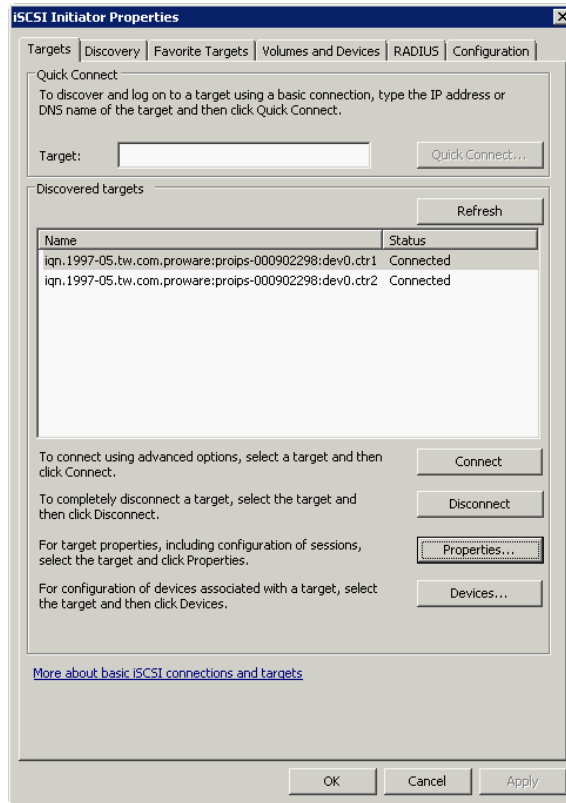

36. Done, the iSCSI device disconnect successfully.