

# **SAS to SAS/SATA JBOD Subsystem**

## **User Manual**

**Revision 1.0**

# Table of Contents

<b>Chapter 1 Introduction.....</b>	<b>3</b>
1.1 Features.....	3
1.2 Technical Specifications.....	4
1.3 Unpacking the JBOD Subsystem.....	5
1.4 Identifying Parts of the JBOD Subsystem.....	6
1.4.1 Front View.....	6
1.4.2 Rear View.....	7
1.4.3 JBOD Controller Module.....	8
1.4.3.1 JBOD Controller Panel.....	8
1.5 Power Supply Fan Module (PSFM).....	9
1.5.1 PSFM Panel.....	9
1.6 LCD Display Panel.....	11
1.6.1 LCD Panel LED.....	11
1.6.2 LCD Panel Function Buttons.....	12
1.7 Drive Carrier Module.....	13
1.7.1 Disk Drive Status Indicators.....	13
1.7.2 Drive Carrier Lock Indicator.....	14
<b>Chapter 2 Installation of JBOD Subsystem.....</b>	<b>15</b>
2.1 Powering On.....	15
2.2 Disk Drive Installation.....	16
2.2.1 Installing a 3.5" SAS Disk Drive in a Disk Tray.....	16
2.2.2 Installing 2.5" Disk Drive in a Disk Tray.....	19
2.2.3 Installing a 3.5" SATA Disk Drive (Dual Controller Mode) in a Disk Tray.....	21
2.2.4 Installing 2.5" SATA Disk Drive (Dual Controller Mode) in a Disk Tray.....	25
2.3 Connecting the JBOD Subsystem.....	29
2.3.1 Connecting to SAS HBA.....	29
2.3.2 Connecting to RAID Subsystem.....	29
<b>Chapter 3 Maintenance.....</b>	<b>30</b>
3.1 Monitoring the RAID Environment.....	30
3.2 Upgrading Firmware.....	32
3.3 Replacing JBOD Subsystem Components.....	34
3.3.1 Replacing JBOD Controller Module.....	34
3.3.1.1 Replacing Controller Module with Controller Blanking Plate.....	34
3.3.2 Replacing Power Supply Fan Module.....	35
3.3.2.1 Replacing Power Supply Fan Module with Plate Cover.....	36

## Chapter 1 Introduction



### The 12 bays JBOD Subsystem

This JBOD subsystem is a 19-inch 2U rackmount JBOD unit. It is a versatile SAS2 / SATA3 disk expansion system, ideal for high capacity and scalability storage in IT demands. It offers high density storage, hardware redundancy and easily integrates into versatile applications that request high performance and high scalability.

This JBOD subsystem comes with either dual or single JBOD controller configuration for options. It features a modular architecture for all key components which ease system maintenance and management.

## 1.1 Features

### Highest Density Available

- 2U chassis with 12 bays carriers
- Support the 2.5" / 3.5" enterprise class SAS2/SATA3 HDD drives

### High Availability

- Single or dual SAS JBOD controller module
- Each SAS JBOD controller module consist of three 4x mini SAS HD ports

### Power Supply

- Power supply and cooling system contained in 1 module for efficient cooling
- Two 400W redundant hot swappable power supplies

### Enclosure

- Incorporates a cableless design for maximum signal integrity
- Utilizes industry-standard SCSI enclosure services (SES) to monitor enclosure and disk environmental conditions

### Enclosure monitoring

- S.E.S. support for standard enclosure management
- System LED indications
- Fan speed monitoring
- Power supply monitoring
- System voltage monitoring
- System temperature monitoring
- System alarm







## 1.2 Technical Specifications

<b>JBOD Controller</b>	Single / Redundant
<b>Host Interface</b>	One 4x mini SAS HD (12Gb/s) / Two 4x mini SAS HD (12Gb/s)
<b>Disk Interface</b>	6Gb/s SAS, 6Gb/s SATA
<b>SAS expansion</b>	Two 4x mini SAS HD (12Gb/s) / Four 4x mini SAS HD (12Gb/s)
<b>Enclosure</b>	
<b>Platform</b>	Rackmount
<b>Form Factor</b>	2U
<b># of Hot Swap Trays</b>	12
<b>Tray Lock</b>	Yes
<b>Disk Status Indicator</b>	Access / Fail LED
<b>Backplane</b>	SAS / SATA Single BP
<b># of PS/Fan Modules</b>	400W x 2 w/PFC
<b># of Fans</b>	2
<b>Monitor port support</b>	Yes
<b>Power requirements</b>	AC 90V ~ 264V Full Range, 8A ~ 4A, 47Hz ~ 63Hz
<b>Environmental</b>	
<b>Relative Humidity</b>	10% ~ 85% Non-condensing
<b>Operating Temperature</b>	10°C ~ 40°C (50°F ~ 104°F)
<b>Physical Dimension</b>	590(L) x 482 (W) x 88(H) mm
<b>Weight (Without Disk)</b>	18.2 / 19.7 Kg

Specification is subject to change without notice.

### 1.3 Unpacking the JBOD Subsystem

The shipping package contains the following:

	JBOD Subsystem Unit
	Two (2) power cords
	<p>One (1) external serial cable RJ11-to-DB9 for single JBOD controller</p> <p>Note: Two (2) serial cables for dual JBOD controllers</p>
	<p>One (1) external SAS cable (mini SAS HD to mini SAS)</p> <p>Note: Two (2) SAS cables for dual JBOD controllers</p>
	<p>One(1) JBOD Controller Module Plate Cover</p> <p>NOTE: For Dual RAID Controller</p>
	One(1) PSFM Plate Cover
	User Manual



**NOTE: If any damage is found, contact the dealer or vendor for assistance.**

## 1.4 Identifying Parts of the JBOD Subsystem

The illustrations below identify the various parts of the expansion chassis.

### 1.4.1 Front View



## 1.4.2 Rear View

### Single JBOD Controller

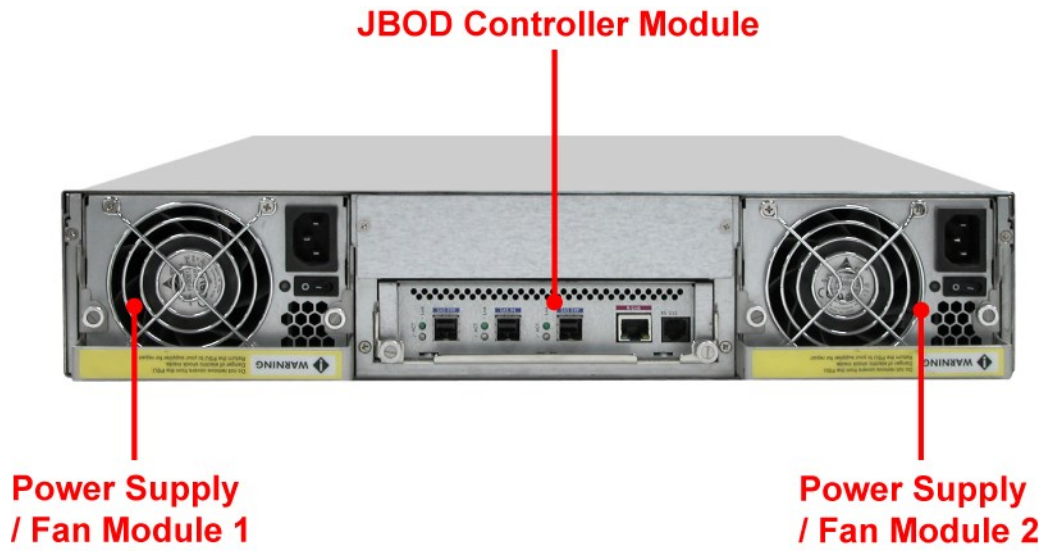

### Dual JBOD Controller

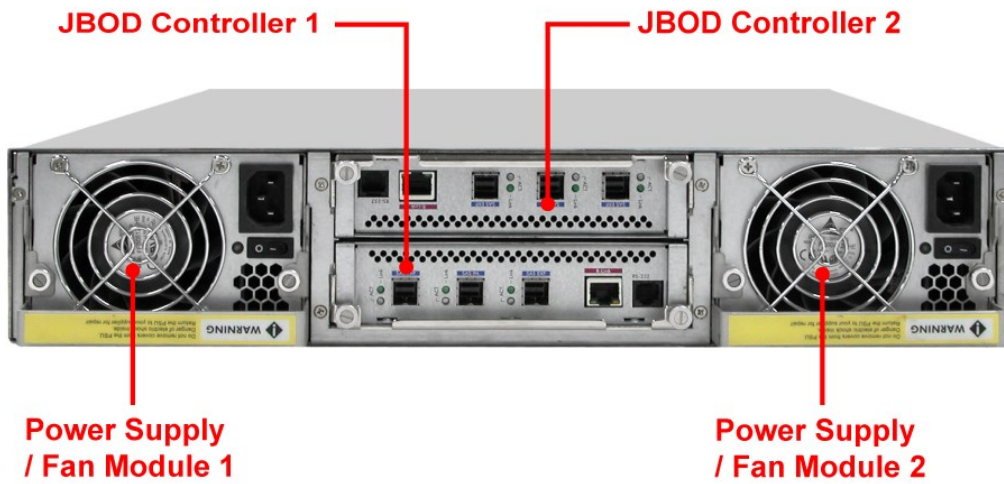

### 1.4.3 JBOD Controller Module

#### 1.4.3.1 JBOD Controller Panel

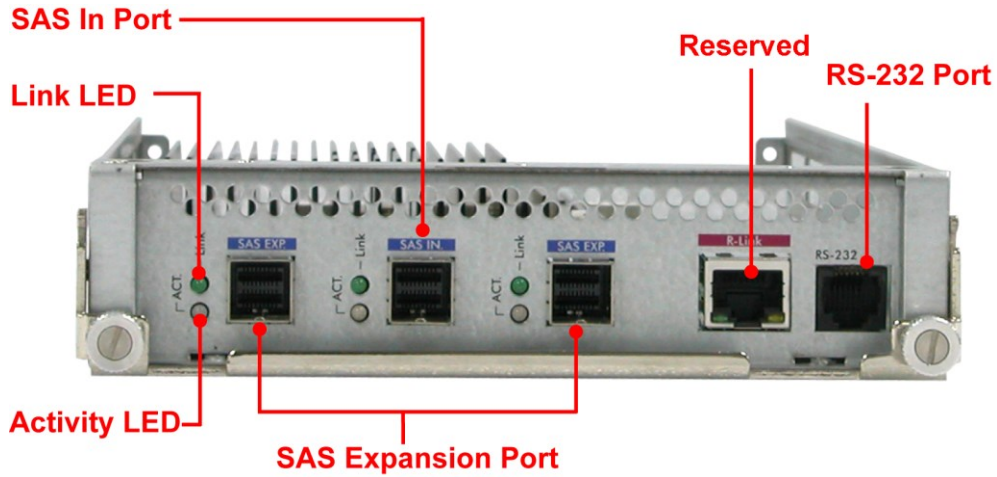

Part	Description
<b>SAS In Port</b>	Use to connect to SAS HBA or to RAID subsystem's SAS Expansion Port.
<b>SAS Expansion Port</b>	Use to connect to the SAS In Port of another JBOD subsystem.
<b>RS-232 Port</b>	Use to upgrade the firmware of the JBOD controller. Connect the RJ11-to-DB9 serial cable to your system's serial port.

Indicator	Color	Description
<b>Link LED</b>	<b>Green</b>	Indicates expander has connected or linked.
<b>Activity LED</b>	<b>Blinking Blue</b>	Indicates the expander is busy and being accessed.



## 1.5 Power Supply Fan Module (PSFM)

The JBOD subsystem contains **two 400W Power Supply / Fan Modules**. All PSFMs are inserted into the rear of the chassis.



### 1.5.1 PSFM Panel

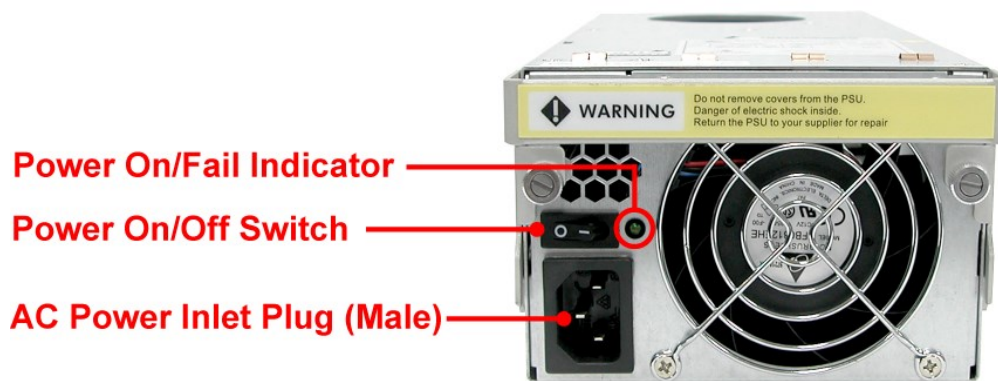

The panel of the Power Supply/Fan Module contains: the Power On/Off Switch, the AC Inlet Plug, and a Power On/Fail Indicator showing the Power Status LED, indicating ready or fail.

Each fan within a PSFM is powered independently of the power supply within the same PSFM. So if the power supply of a PSFM fails, the fan associated with that PSFM will continue to operate and cool the enclosure.

When the power cord connected from main power source is inserted to the AC Power Inlet, the power status LED becomes **RED**. When the switch of the PSFM is turned on, the LED will turn **GREEN**. When the Power On/Fail LED is **GREEN**, the PSFM is functioning normally.



**NOTE:** Each PSFM has one Power Supply and one Fan. PSFM 1 has Power#1 and Fan#1, and PSFM 2 has Power#2 and Fan#2. When the Power Supply of a PSFM fails, the PSFM need not be removed from the slot if replacement is not yet available. The fan will still work and provide necessary airflow inside the enclosure.

In replacing the failed PSFM, refer to section 3.3.2 of this manual.







**NOTE:** After replacing the Power Supply Fan Module and turning on the Power On/Off Switch of the PSFM, the Power Supply will not power on immediately. The Fans in the PSFM will spin-up until the RPM becomes stable. When Fan RPM is already stable, the RAID controller will then power on the Power Supply. This process takes more or less 30 seconds. This safety measure helps prevent possible Power Supply overheating when the Fans cannot work.

## 1.6 LCD Display Panel



### 1.6.1 LCD Panel LED



Parts	Function
Power LED	Green indicates power is ON.
Power Fail LED 	If one of the redundant power supply unit fails, this LED will turn to RED and alarm will sound.
Fan Fail LED 	Turn RED when fan 1 or 2 fails, or speed is lower than 500 RPM.
Over Temperature LED 	If disk temperatures exceed 60°C, the Over Temperature LED will turn RED and alarm will sound.
Voltage Warning LED 	An alarm will sound if detected voltage in the controller is abnormal and LED will turn RED.

## 1.6.2 LCD Panel Function Buttons



Parts		Function
Up and Down Arrow buttons	▲ ▼	Use the Up or Down arrow keys to go through the information on the LCD screen. This is also used to move between each menu.
Select button	✓	This is used to enter the option you have selected.
Exit button	EXIT	Press this button to return to the previous menu.

## 1.7 Drive Carrier Module

The Drive Carrier Module houses a 3.5 inch hard disk drive. It is designed for maximum airflow and incorporates a carrier locking mechanism to prevent unauthorized access to the HDD.



### 1.7.1 Disk Drive Status Indicators

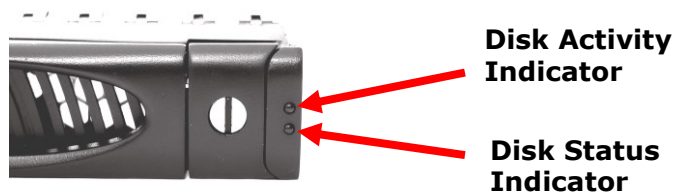

Part	Function
Disk Activity Indicator	This LED will blink blue when the hard drive is being accessed.
Disk Status Indicator	Green LED indicates power is on and hard drive status is good for this slot. If there is no hard drive, the LED is Red. The fault indicator depends on the RAID card or RAID Controller definition.

## 1.7.2 Drive Carrier Lock Indicator

Every Drive Carrier is lockable and is fitted with a lock indicator to indicate whether or not the carrier is locked into the chassis or not. Each carrier is also fitted with an ergonomic handle for easy carrier removal.

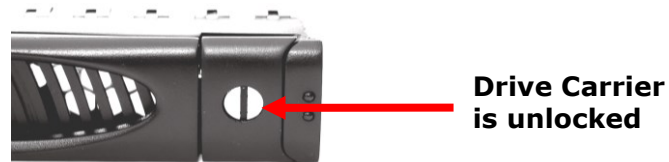

When the Lock Groove is vertical, then the Drive Carrier is unlocked.

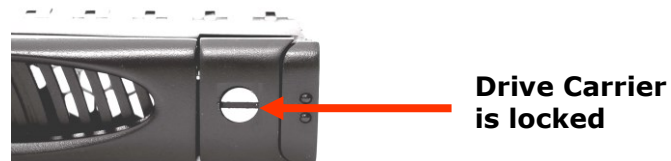

When the Lock Groove is horizontal, this indicates that the Drive Carrier is locked.

Lock and unlock the Drive Carriers by using a flat-head screw driver.

## Chapter 2 Installation of JBOD Subsystem

### 2.1 Powering On

1. Plug in the power cords into the AC Power Input Socket located at the rear of the subsystem.

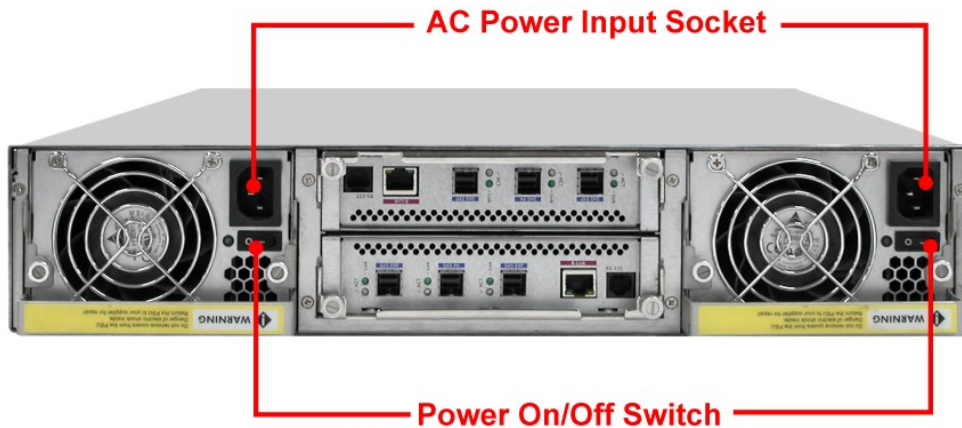

**NOTE:** The subsystem is equipped with redundant, full range power supplies with PFC (power factor correction). The system will automatically select voltage.

2. Turn on each Power On/Off Switch to power on the subsystem.
3. The Power LED on the front panel will turn green.

## 2.2 Disk Drive Installation

This section describes the physical locations of the hard drives supported by the subsystem and give instructions on installing a hard drive. The subsystem supports hot-swapping allowing you to install or replace a hard drive while the subsystem is running.

### 2.2.1 Installing a 3.5" SAS Disk Drive in a Disk Tray



**NOTE: These steps are the same when installing SATA disk drive in Single Controller Mode.**

1. Unlock the Disk Trays using a flat-head screw driver by rotating the Lock Groove.

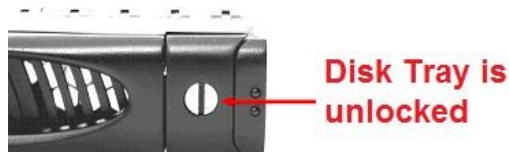

2. Press the Tray Open button and the Disk Tray handle will flip open.



3. Pull out an empty disk tray.





- Place the hard drive in the disk tray. Turn the disk tray upside down. Align the four screw holes of the SAS disk drive in the four Hole A of the disk tray. To secure the disk drive into the disk tray, tighten four screws on these holes of the disk tray. Note in the picture below where the screws should be placed in the disk tray holes.



**NOTE: The mounting hole locations of the new 6-disk are different from the existing drives.**

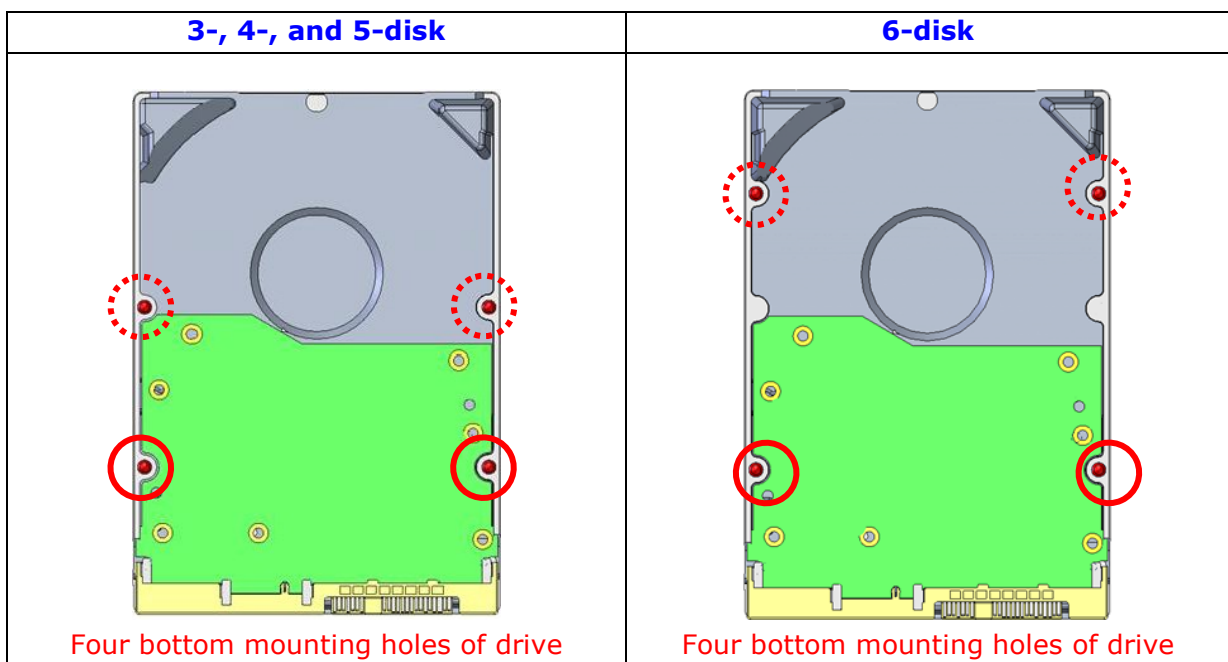

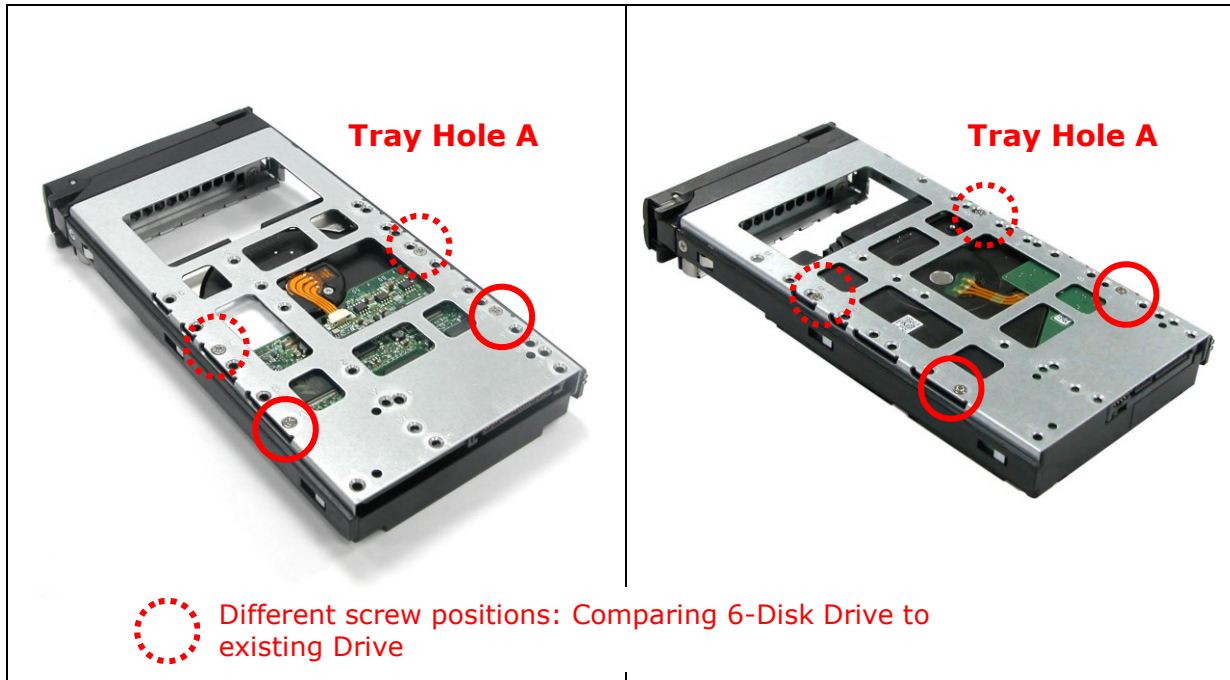

**NOTE: All the disk tray holes are labelled accordingly.**

5. Slide the tray into a slot.
6. Press the lever in until you hear the latch click into place. The HDD Fault LED will turn green when the subsystem is powered on and HDD is good.
7. If necessary, lock the Disk Tray by turning the Lock Groove.

## 2.2.2 Installing 2.5" Disk Drive in a Disk Tray

1. Remove an empty disk tray from the subsystem.



2. Place the disk drive in the disk tray. Turn the disk tray upside down. Align the four screw holes of the disk drive in the four *Hole w* of the disk tray. To secure the disk drive into the disk tray, tighten four screws on these holes of the disk tray. Note in the picture below where the screws should be placed in the disk tray holes.



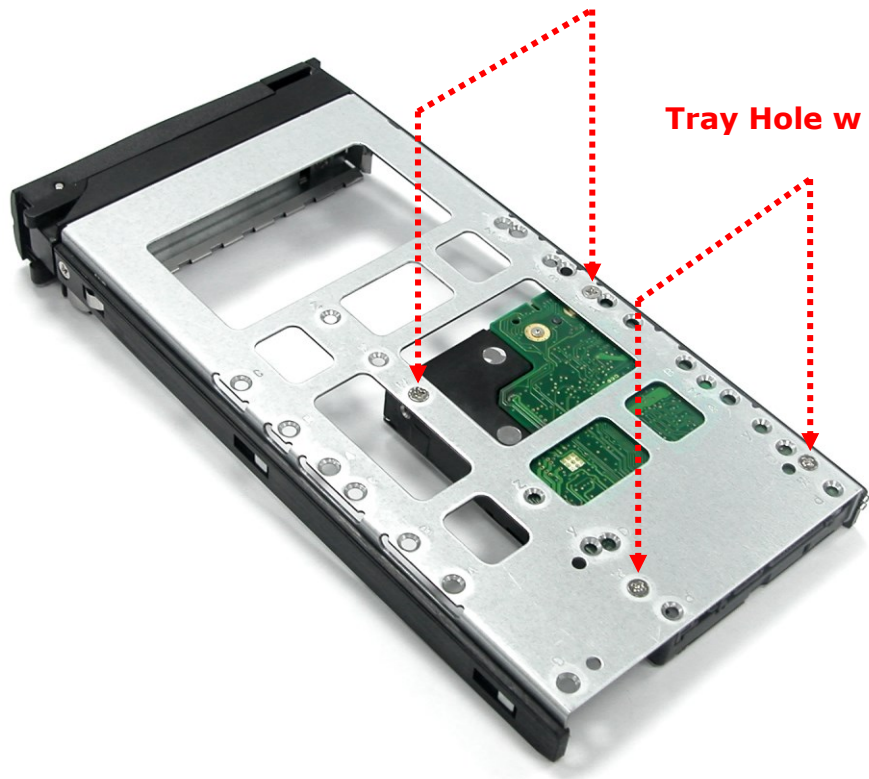

**NOTE: All the disk tray holes are labelled accordingly.**



3. Slide the tray into a slot.
4. Press the lever in until you hear the latch click into place. The HDD Fault LED will turn green when the subsystem is powered on and HDD is good.

### 2.2.3 Installing a 3.5" SATA Disk Drive (Dual Controller Mode) in a Disk Tray

1. Remove an empty disk tray from the subsystem.

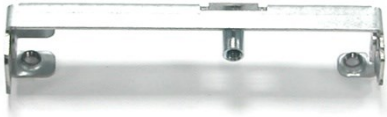

2. Prepare the dongle board, the Fixed Bracket, and screws.

	<b>Fixed Bracket</b>
	<b>Dongle Board</b>
	<b>Screws</b>

3. Attach the dongle board in the Fixed Bracket with a screw.

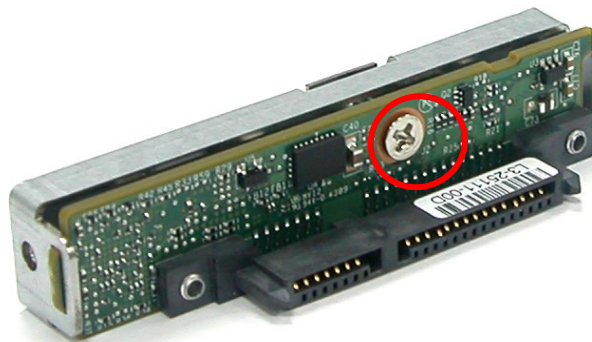

4. Place the Fixed Bracket with the dongle board in the disk tray as shown.

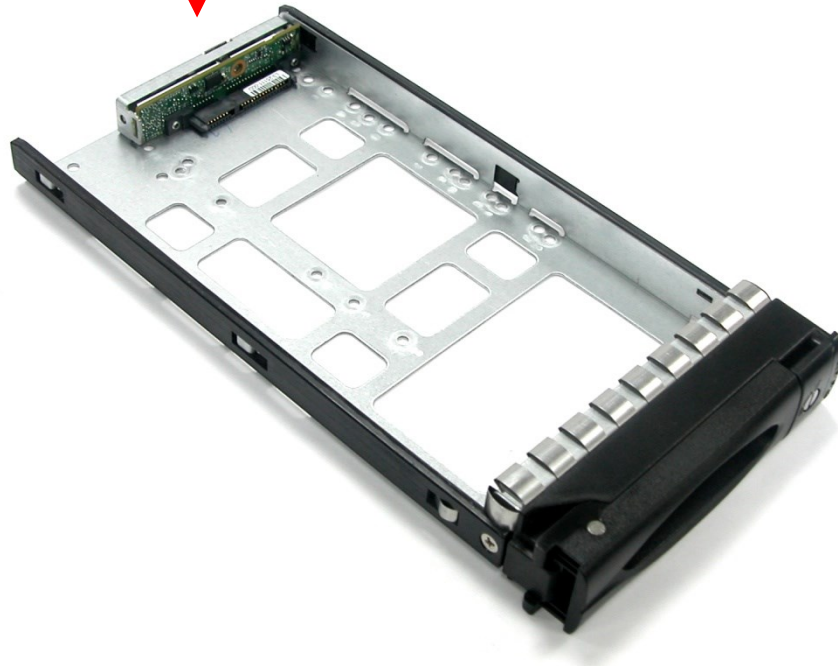
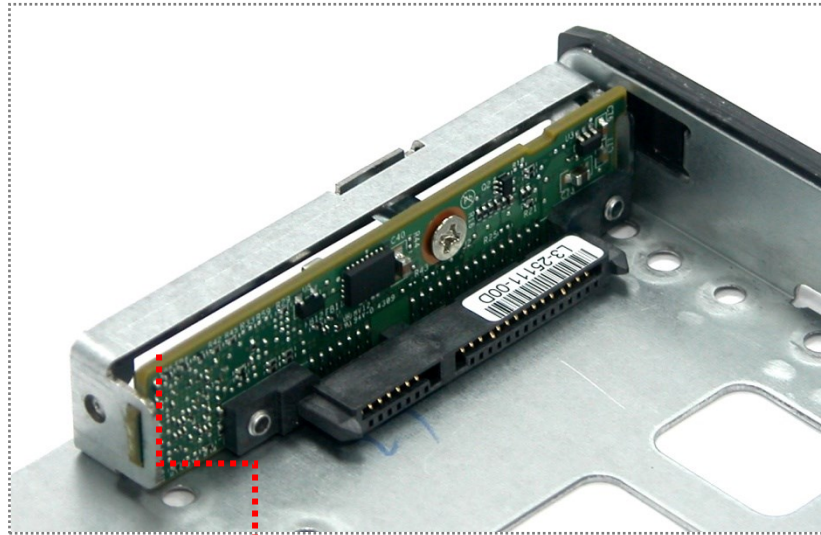

5. Turn the tray upside down. Align the holes of the Fixed Bracket in the two *Hole d* of the disk tray. Tighten two screws to secure the Fixed Bracket into the disk tray.

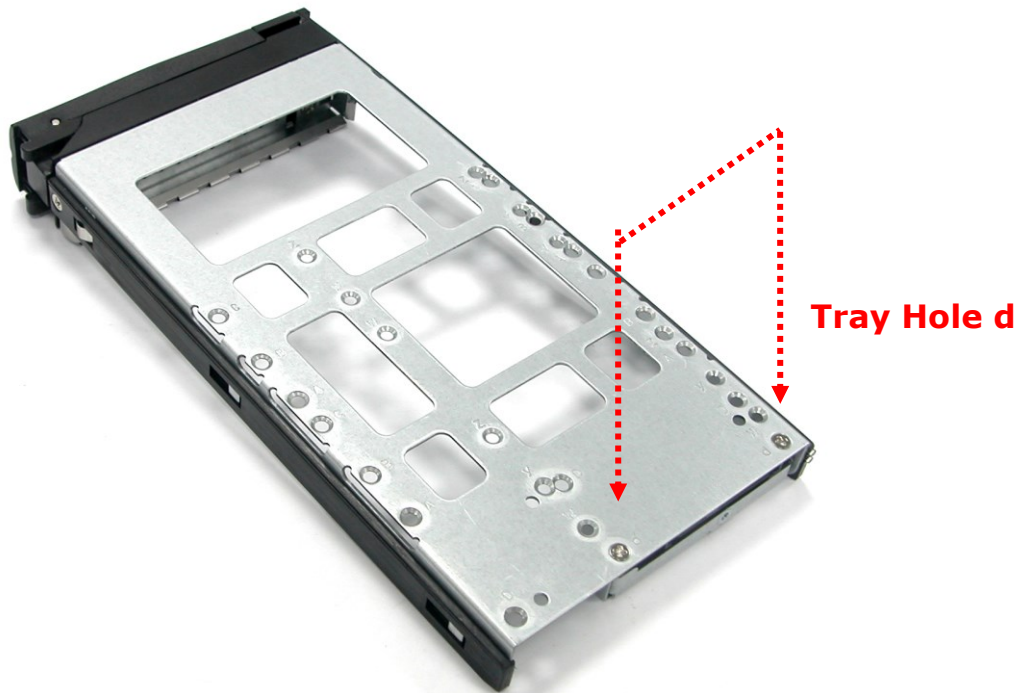

**NOTE: All the disk tray holes are labelled accordingly.**

6. Place the SATA disk drive into the disk tray. Slide the disk drive towards the dongle board.



- Turn the disk tray upside down. Align the four screw holes of the SATA disk drive in the four *Hole B* of the disk tray. To secure the disk drive into the disk tray, tighten four screws on these holes of the disk tray. Note in the picture below where the screws should be placed in the disk tray holes.



**NOTE: The mounting hole locations of the new 6-disk are different from the existing drives.**

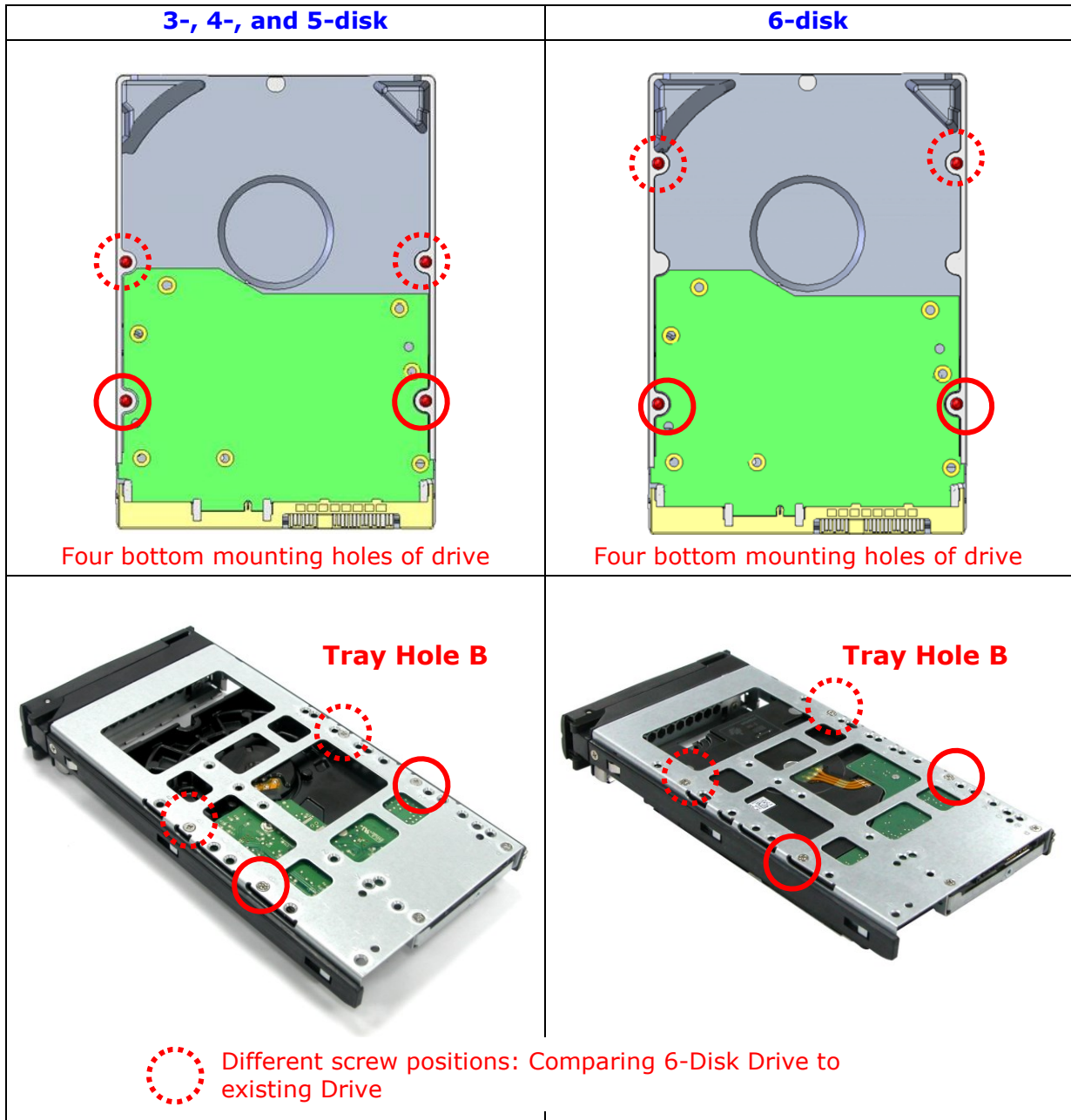

**NOTE: All the disk tray holes are labelled accordingly.**

- Insert the disk tray into the subsystem.





## 2.2.4 Installing 2.5" SATA Disk Drive (Dual Controller Mode) in a Disk Tray

1. Remove an empty disk tray from the subsystem.



2. Prepare the dongle board, the Fixed Bracket, and screws.

	<b>Fixed Bracket</b>
	<b>Dongle Board</b>
	<b>Screws</b>

3. Attach the dongle board in the Fixed Bracket with a screw.

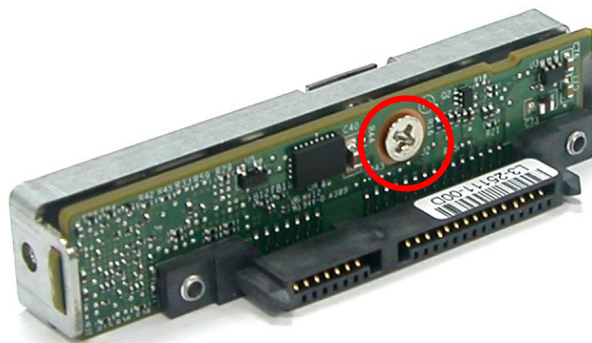

4. Place the Fixed Bracket with the dongle board in the disk tray as shown.

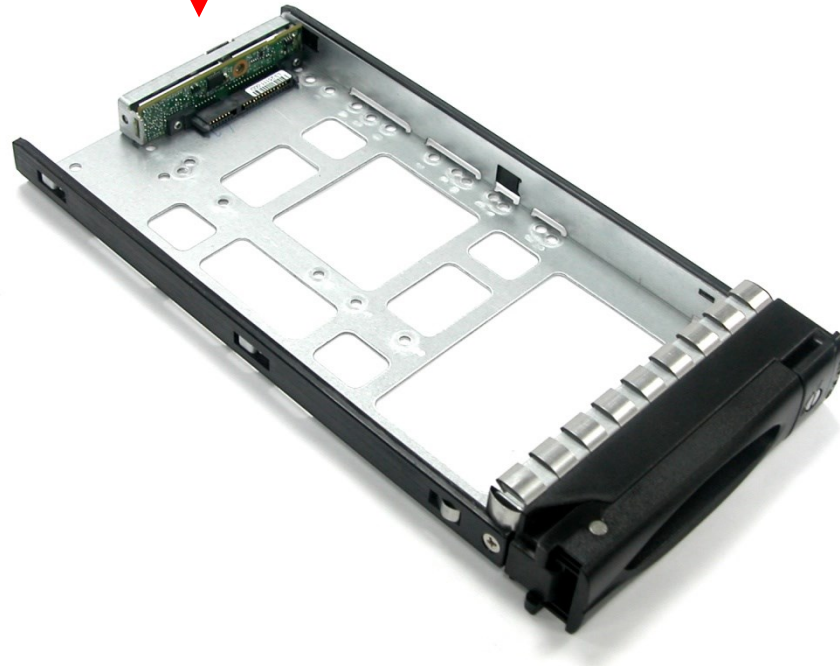
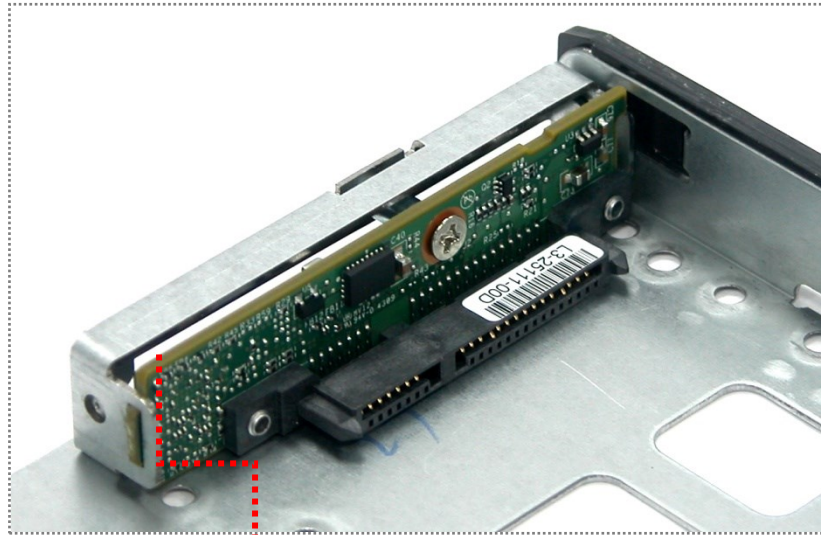

5. Turn the tray upside down. Align the holes of the Fixed Bracket in the two *Hole d* of the disk tray. Tighten two screws to secure the Fixed Bracket into the disk tray.

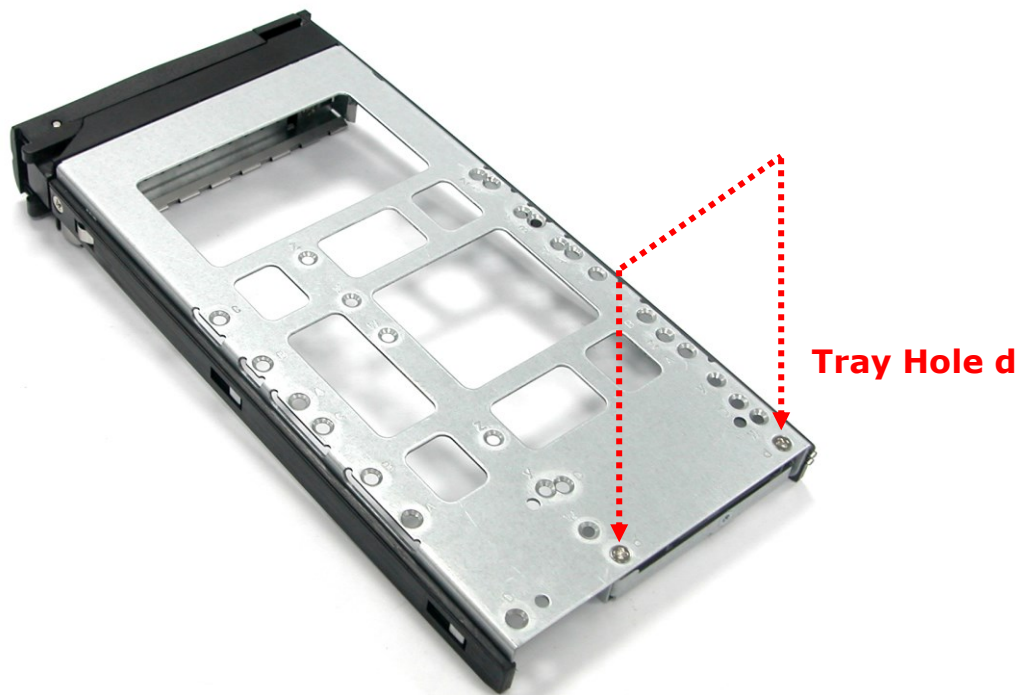

**NOTE: All the disk tray holes are labelled accordingly.**

6. Place the 2.5" SATA disk drive into the disk tray. Slide the disk drive towards the dongle board.



7. Turn the disk tray upside down. Align the four screw holes of the 2.5" SATA disk drive in the four *Hole y* of the disk tray. To secure the disk drive into the disk tray, tighten four screws on these holes of the disk tray. Note in the picture below where the screws should be placed in the disk tray holes.

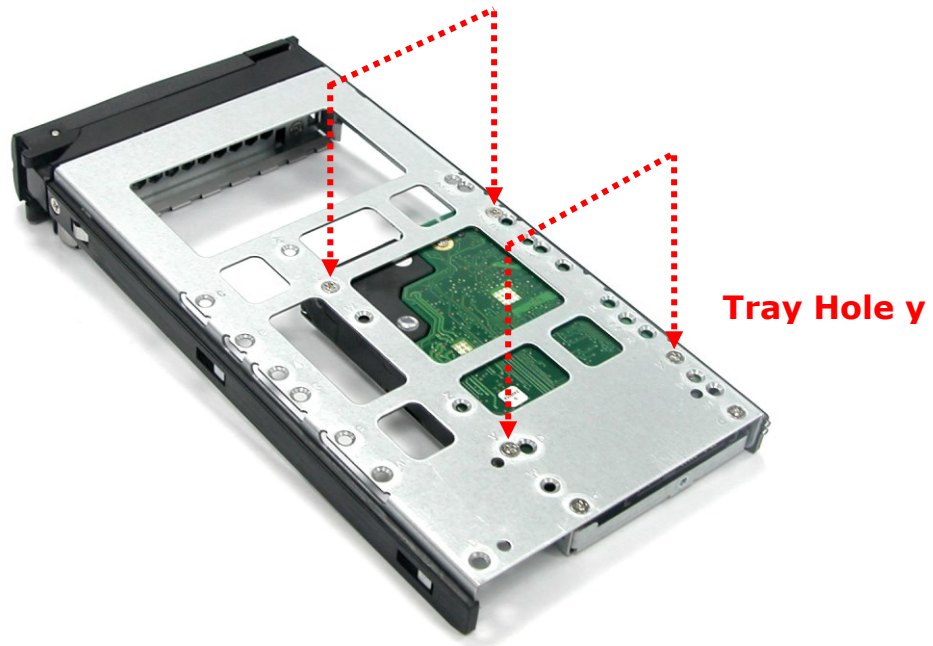

**NOTE: All the disk tray holes are labelled accordingly.**

8. Insert the disk tray into the subsystem.

## 2.3 Connecting the JBOD Subsystem

### 2.3.1 Connecting to SAS HBA

The Enclosure supports SAS interface which provides fast 1200MB data transfer rate using SAS phy. The package comes with one SAS cable for single JBOD controller module, or two SAS cables for redundant JBOD controller modules.

Attach one end of the SAS cable to the SAS IN Port and the other end to the host bus adapter's (HBA) external SAS connector or to the SAS Switch. (The host bus adapter is installed in your Host computer system.)

### 2.3.2 Connecting to RAID Subsystem

Attach one end of the SAS cable to the SAS IN Port of the JBOD controller module and the other end to the SAS Expansion Port on the RAID controller of RAID subsystem. If configured in redundant mode, connect the other SAS cable to the SAS IN Port of the other JBOD controller, and the other end to the SAS Expansion Port on the other RAID controller of RAID subsystem.

## Chapter 3 Maintenance

### 3.1 Monitoring the RAID Environment

After power on the enclosure, the screen on the LCD panel will show the following message:

```
{Model Name}
<ALARM MENU
```

Press the "▼" button to enter the menu

The following tree diagram is a summary of the various monitor functions that can be accessed through the LCD panel.

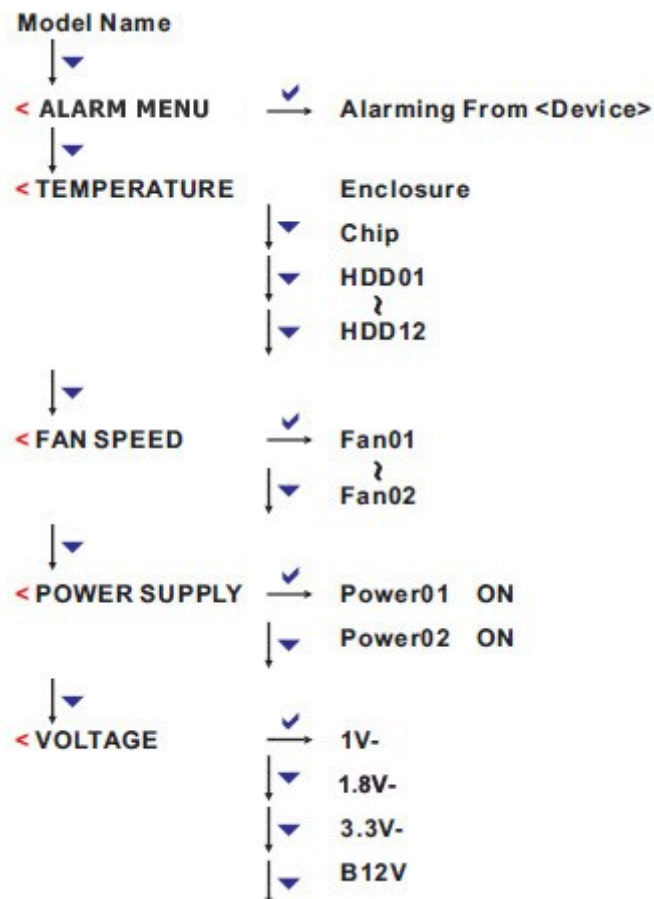

Press the "▼" button to enter the configure menu.

The enclosure has a setup configuration utility allows user to set temperature, LINK, FAN, Alarm and Password. The following tree diagram is a summary of the various setting functions that can be accessed through the LCD panel.

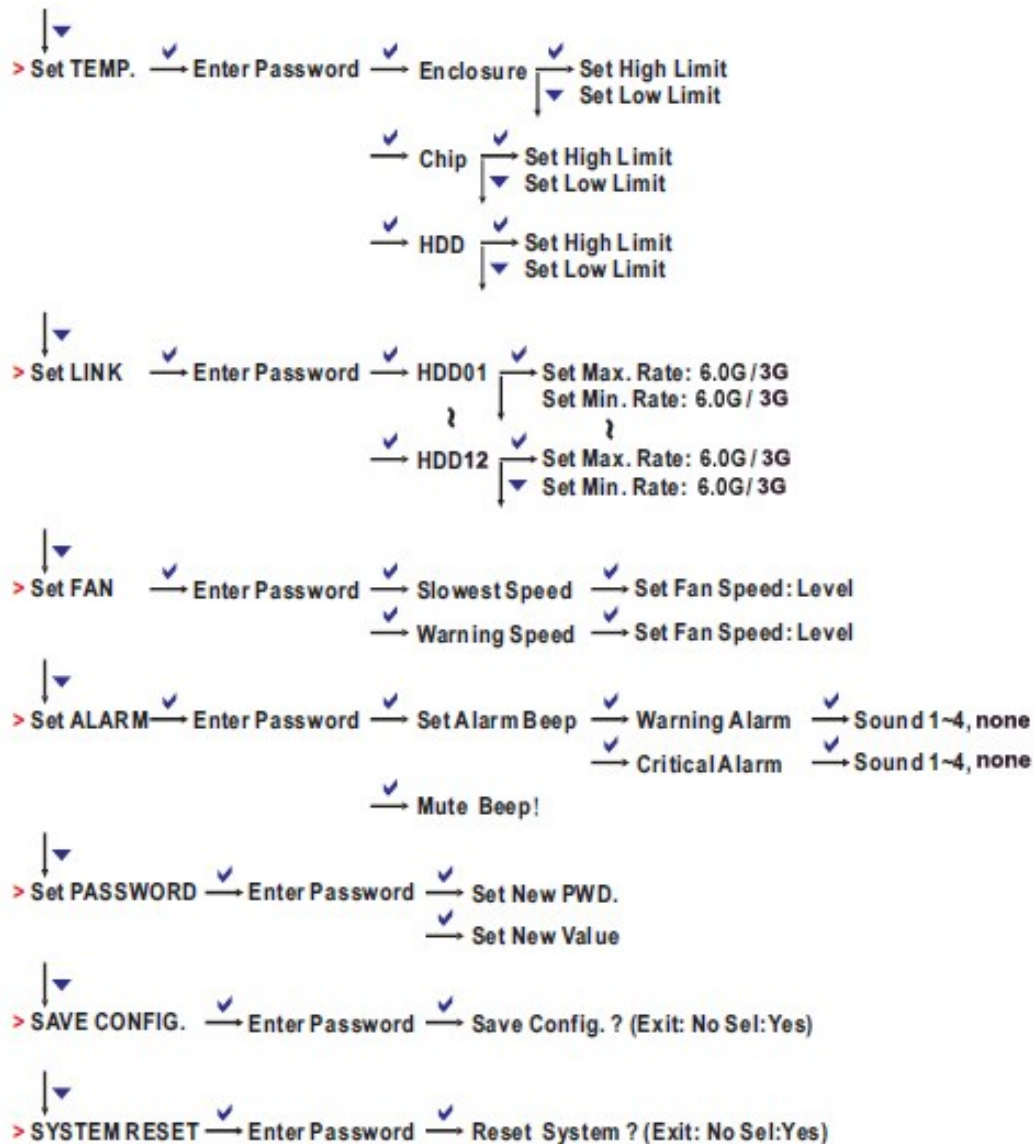

## 3.2 Upgrading Firmware

### Upgrading Firmware through Terminal



**NOTE: It is important to stop I/O access to JBOD subsystem during firmware upgrade.**

**NOTE: Upgrading the firmware must be done from Master JBOD Controller if the JBOD Subsystem has redundant JBOD Controllers.**

1. Please use the RS232 cable (RJ11 to DB9) to JBOD Controller #1 and to connect JBOD RS232 Port and PC COM1 Port (or change to other COM Port as necessary).
2. Open Windows HyperTerminal Program. Connect using COM1 (COM Port used in Step1), Baud Rate: 115200, n, 8, 1, Flow Control: None.
3. Press the Enter key and the password prompt will be displayed.
4. Key in the password (Default password: 00000000) to login to CLI.
5. At CLI prompt, input the command to update firmware.

**A. CLI> mo**

Operation Mode: Master, CLI Dual, M.Sensor, I2C

Operation Mode: Backup

Operation Mode: Single

**NOTE:**

**If Operation Mode is "Master, CLI Dual, M.Sensor, I2C", it means you are connected to Master Expander and you can continue with next steps.**

**If Operation Mode is "Backup", it means you are connected to Backup Expander. Remove RS232 serial cable and insert to other JBOD RS232 Port.**

**If Operation Mode is "Single", it means this JBOD subsystem has only one controller, please skip to step D.**

**B. CLI> mo fdl both**

**C. CLI> mo**

Operation Mode: Master, CLI Dual, M.Sensor, I2C, fdl both



D. **CLI>****NOTE:**

**"fdl code" is the command to update flash firmware code (.fw file).**

**"fdl mfgb" is the command to update CFG data code (.rom file) Make sure you have both files before updating.**

E. **CLI> fdl mfgb**

Please Use XModem Protocol for File Transmission.

Use Q or q to quit Download before starting XModem.

- F. Select Function menu to transfer CFG data .rom file: "Function" → "Transfer" → "Send File" → "Browse" → "Open" and select the .rom file (for example: **8018-mfgdat12-20140822.rom**) firmware folder location. Select "Xmodem" Protocol to send firmware file (**Only need about 60 seconds to finish sending firmware file. If not, please repeat steps E again**).

Note. If won't to transfer CFG data .rom file, Press Q or q to quit Download before starting data transfer.

G. **CLI>fdl code**

Please Use XModem Protocol for File Transmission.

Use Q or q to quit Download before starting XModem.

- H. Select Functon menu to transfer firmware file: "Function" → "Transfer" → "Send File" → "Browse" → "Open" and select the .fw file (for example: **8018-03.B0.00.1F-20140822.fw**) from firmware folder location. Select "Xmodem" Protocol to send firmware file (**Only need about 60 seconds to finish sending firmware file. If not, please repeat steps G again**).

Note. If won't to transfer firmware data .fw file, Press Q or q to quit Download before starting data transfer.

- I. Use "reset" command to Restart JBOD or power cycle

- J. Re-login to JBOD CLI.

- K. Use "sys" command to verify JBOD firmware version.

**CLI>sys**

- L. If needed, the "reset" command can also be used to restart the JBOD controller. (Normally used in single JBOD Controller mode, If already to connect to Controller )

**CLI>reset**

## 3.3 Replacing JBOD Subsystem Components

### 3.3.1 Replacing JBOD Controller Module

When replacing a failed JBOD Controller Module, please follow these steps:

1. Loosen the thumbscrews on the sides of the JBOD Controller Module drawer.
2. Use the Controller handle to pull out the defective JBOD Controller Module drawer.
3. Insert and slide the new JBOD Controller Module in. Note that it may be necessary to remove the old/defective JBOD Controller Module from the drawer case and install the new one.



**IMPORTANT: When replacing a failed component online, it is not recommended to remove the failed component for a long period of time; proper air flow within the enclosure might fail causing high controller/disk drive temperature.**

4. Tighten the thumbscrews on the sides of the JBOD Controller Module case.



#### 3.3.1.1 Replacing Controller Module with Controller Blanking Plate

When replacing a failed JBOD Controller Module with Blanking Plate, please follow these steps:

1. Loosen thumbscrews of the failed JBOD Controller Module drawer.
2. Use the Controller Module handle to remove the failed JBOD Controller Module drawer from the subsystem.
3. Insert the JBOD Controller Blanking Plate.
4. Tighten the screws of the Controller Blanking Plate.

### 3.3.2 Replacing Power Supply Fan Module

When replacing a failed power supply fan module (PSFM), please follow these steps:

1. Turn off the Power On/Off Switch of the failed PSFM.
2. Disconnect the power cord from the AC Inlet Plug of PSFM.
3. Loosen thumbscrews of the PSFM.
4. Use the handle to pull out the defective PSFM.
5. Before inserting the new PSFM, make sure the Power On/Off Switch is on "Off" state.
6. Insert and slide the new PSFM in until it clicks into place.



**IMPORTANT: When the subsystem is online and a Power Supply fails, and the replacement Power Supply module is not yet available, the failed Power Supply Module can be replaced with the Plate Cover. This is to maintain proper airflow within the enclosure. (Refer to next section)**

**When replacing a failed component online, it is not recommended to remove the failed component for a long period of time; proper air flow within the enclosure might fail causing high controller/disk drive temperature.**

7. Connect the power cord to the AC Inlet Plug of PSFM.
8. Tighten the thumbscrews of the PSFM.
9. Turn on the Power On/Off Switch of the PSFM.



**NOTE: After replacing the Power Supply Fan Module and turning on the Power On/Off Switch of the PSFM, the Power Supply will not power on immediately. The Fans in the PSFM will spin-up until the RPM becomes stable. When Fan RPM is already stable, the RAID controller will then power on the Power Supply. This process takes more or less 30 seconds. This safety measure helps prevent possible Power Supply overheating when the Fans cannot work.**

### **3.3.2.1 Replacing Power Supply Fan Module with Plate Cover**

When replacing a failed power supply fan module (PSFM) with Plate Cover, please follow these steps:

1. Turn off the Power On/Off Switch of the failed PSFM.
2. Disconnect the power cord from the AC Inlet Plug of PSFM.
3. Loosen thumbscrews of the failed PSFM.
4. Pull out the defective PSFM.
5. Insert the PSFM Plate Cover carefully.