

SAS to SAS/SATA RAID Subsystem

User Manual

Revision 1.0

Table of Contents

Preface	5
Before You Begin	6
Safety Guidelines.....	6
Controller Configurations.....	6
Packaging, Shipment and Delivery.....	6
Unpacking the Shipping Carton.....	7
Chapter 1 Product Introduction.....	8
1.1 Technical Specifications.....	10
1.2 RAID Concepts	11
1.3 Array Definition.....	16
1.3.1 RAID Set.....	16
1.3.2 Volume Set	16
1.4 High Availability.....	17
Chapter 2 Identifying Parts of the RAID Subsystem.....	18
2.1 Main Components.....	18
2.1.1 Front View.....	18
2.1.2 Rear View.....	19
2.2 Controller Module.....	20
2.2.1 Controller Module Panel.....	20
2.3 Power Supply / Fan Module (PSFM).....	22
2.3.1 PSFM Panel.....	24
2.4 Turbo Fan (Fan 06-1).....	25
2.5 Expander Module.....	26
2.5.1 Expander Module Panel	26
2.6 Disk Tray	27
2.6.1 Disk Drive Status LEDs.....	28
2.6.2 Disk Drive Installation.....	29
2.7 LCD Display Panel.....	34
2.7.1 LCD Display Panel LEDs.....	34
Chapter 3 Getting Started with the Subsystem.....	36
3.1 Installing the Rails and Mounting into Rack	36
3.2 Preparing the RAID Subsystem.....	49
3.3 Powering On	49

3.4	Powering Off	51
Chapter 4	RAID Configuration Utility Options	52
4.1	Configuration through Telnet.....	52
4.2	Configuration through the LCD Panel.....	57
4.2.1	Menu Diagram	58
4.3	Configuration via web browser-based proRAID Manager.....	64
Chapter 5	RAID Management.....	66
5.1	Quick Function	66
5.1.1	Quick Create.....	66
5.2	RAID Set Functions.....	68
5.2.1	Create RAID Set	68
5.2.2	Delete RAID Set	69
5.2.3	Expand RAID Set.....	70
5.2.4	Offline RAID Set.....	73
5.2.5	Rename RAID Set.....	74
5.2.6	Activate Incomplete RAID Set.....	75
5.2.7	Create Hot Spare.....	77
5.2.8	Delete Hot Spare.....	78
5.2.9	Rescue RAID Set	79
5.3	Volume Set Function	80
5.3.1	Create Volume Set.....	80
5.3.2	Create RAID 30/50/60	83
5.3.3	Delete Volume Set.....	84
5.3.4	Modify Volume Set.....	85
5.3.5	Check Volume Set.....	88
5.3.6	Schedule Volume Check.....	90
5.3.7	Stop Volume Check.....	90
5.4	Physical Drive.....	91
5.4.1	Create Pass-Through Disk	91
5.4.2	Modify a Pass-Through Disk	92
5.4.3	Delete Pass-Through Disk	92
5.4.4	Identify Enclosure	93
5.4.5	Identify Selected Drive	94
5.5	System Controls.....	95
5.5.1	System Configuration	95
5.5.2	HDD Power Management.....	97
5.5.3	EtherNet Configuration.....	99
5.5.4	Alert By Mail Configuration	100
5.5.5	SNMP Configuration	101

5.5.6	NTP Configuration	102
5.5.7	View Events / Mute Beeper	103
5.5.8	Generate Test Event	104
5.5.9	Clear Event Buffer	104
5.5.10	Modify Password.....	105
5.5.11	Upgrade Firmware.....	105
5.5.12	Shutdown Controller	106
5.5.13	Restart Controller.....	107
5.6	Information Menu.....	108
5.6.1	RAID Set Hierarchy	108
5.6.2	SAS Chip Information.....	109
5.6.3	System Information	110
5.6.4	Hardware Monitor.....	111
Chapter 6	Maintenance.....	112
6.1	Upgrading the RAID Controller's Cache Memory	112
6.1.1	Replacing the Memory Module	112
6.2	Upgrading the RAID Controller's Firmware	113
6.3	Replacing Subsystem Components.....	120
6.3.1	Replacing a Disk Drive	121
6.3.2	Replacing the RAID Controller Module	127
6.3.3	Replacing the Power Supply Fan Module.....	128
6.3.4	Replacing the Turbo Fan (Fan 06-1)	130
6.3.5	Replacing the Expander Module	132
6.3.7	Replacing the Bottom Board.....	143
Appendix 1	Disk Power Off/On Function in Web GUI.....	151

Preface

About this manual

This manual provides information regarding the hardware features, installation and configuration of the **42 Bays RAID Subsystem** document also describes how to use the storage management software. Information contained in the manual has been reviewed for accuracy, but not for product warranty because of the various environment/OS/settings. Information and specifications will be changed without further notice.

This manual uses section numbering for every topic being discussed for easy and convenient way of finding information in accordance with the user's needs. The following icons are being used for some details and information to be considered in going through with this manual:

**NOTES:**

These are notes that contain useful information and tips that the user must give attention to in going through with the subsystem operation.

**IMPORTANT!**

These are the important information that the user must remember.

**WARNING!**

These are the warnings that the user must follow to avoid unnecessary errors and bodily injury during hardware and software operation of the subsystem.

**CAUTION:**

These are the cautions that user must be aware of to prevent damage to the subsystem and/or its components.

Copyright

No part of this publication may be reproduced, stored in a retrieval system, or transmitted in any form or by any means, electronic, mechanical, photocopying, recording or otherwise, without the prior written consent.

Trademarks

All products and trade names used in this document are trademarks or registered trademarks of their respective owners.

Changes

The material in this document is for information only and is subject to change without notice.

Before You Begin

Before going through with this manual, you should read and focus on the following safety guidelines. Notes about the subsystem's controller configuration and the product packaging and delivery are also included here.

Safety Guidelines

To provide reasonable protection against any harm on the part of the user and to obtain maximum performance, user is advised to be aware of the following safety guidelines particularly in handling hardware components:

Upon receiving of the product:

- ❖ Place the product in its proper location.
- ❖ Do not try to lift it by yourself alone. Two or more persons are needed to remove or lift the product to its packaging. To avoid unnecessary dropping out, make sure that somebody is around for immediate assistance.
- ❖ It should be handled with care to avoid dropping that may cause damage to the product. Always use the correct lifting procedures.

Upon installing of the product:

- ❖ Ambient temperature is very important for the installation site. It must not exceed 30°C. Due to seasonal climate changes; regulate the installation site temperature making it not to exceed the allowed ambient temperature.
- ❖ Before plugging-in any power cords, cables and connectors, make sure that the power switches are turned off. Disconnect first any power connection if the power supply module is being removed from the enclosure.
- ❖ Outlets must be accessible to the equipment.
- ❖ All external connections should be made using shielded cables and as much as possible should not be performed by bare hand. Using anti-static hand gloves is recommended.
- ❖ In installing each component, secure all the mounting screws and locks. Make sure that all screws are fully tightened. Follow correctly all the listed procedures in this manual for reliable performance.

Controller Configurations

This RAID Subsystem supports single controller configurations. The single controller can be configured depending on the user's requirements.

This manual will discuss single controller configuration.

Packaging, Shipment and Delivery

- ❖ Before removing the subsystem from the shipping carton, you should visually inspect the physical condition of the shipping carton.
- ❖ Unpack and verify that the contents of the shipping carton are complete and in good condition.
- ❖ Exterior damage to the shipping carton may indicate that the contents of the carton are damaged.
- ❖ If any damage is found, do not remove the components; contact the dealer where you purchased the subsystem for further instructions.

Unpacking the Shipping Carton

The shipping carton contains the following:

	RAID Subsystem Unit
	42 Disk Trays
	Two (2) power cords
	One (1) external SAS cable
	One (1) RJ45 Ethernet cable
	Three (3) external serial cables RJ11-to-DB9
	Key of Top Cover
	Key of Disk Tray
	User Manual / CD



NOTE: If any damage is found, contact the dealer or vendor for assistance.

Chapter 1 Product Introduction



The RAID Subsystem

The RAID Subsystem features 6Gb SAS host performance to increase system efficiency and performance. It features high capacity expansion, with 42 hot-swappable SAS2/SATA3 hard disk drive bays in a 19-inch 4U rackmount unit, scaling to a maximum storage capacity in the terabyte range.

Exceptional Manageability

- The firmware-embedded Web Browser-based RAID manager allows local or remote management and configuration
- The firmware-embedded SMTP manager monitors all system events and user notification automatically
- The firmware-embedded SNMP agent allows remote to monitor events via LAN with no SNMP agent required
- Menu-driven front panel display
- Innovative Modular architecture

Features

- Supports RAID levels 0, 1, 10(1E), 3, 5, 6, 30, 50, 60 and JBOD
- Supports online Array roaming
- Online RAID level/stripe size migration
- Online capacity expansion and RAID level migration simultaneously
- Support global and dedicated hot spare
- Online Volume Set Expansion
- Support multiple array enclosures per host connection
- Greater than 2TB per volume set (64-bit LBA support)

- Greater than 2TB per disk drive
- Supports 4K bytes/sector for Windows up to 16TB per volume set
- Disk scrubbing/ array verify scheduling for automatic repair of all configured RAID sets
- Login record in the event log with IP address and service (http, telnet and serial)
- Support intelligent power management to save energy and extend service life
- Support NTP protocol to synchronize RAID controller clock over the on-board LAN port
- Max 128 LUNs (volume set) per controller
- Transparent data protection for all popular operating systems
- Instant availability and background initialization
- Supports S.M.A.R.T, NCQ and OOB Staggered Spin-up capable drives
- Supports hot spare and automatic hot rebuild
- Local audible event notification alarm
- Redundant flash image for high availability
- Real time clock support

1.1 Technical Specifications

RAID Controller	6Gb SAS-6Gb SAS
Host Interface	Two 4x mini SAS (6Gb/s)
Disk Interface	6Gb/s SAS or 6Gb/s SATA
SAS expander	One 4x mini SAS (6Gb/s)
- Direct Attached	42 Disks
- Expansion	Up to 126 Disks
Processor Type	800MHz RAID-On-Chip storage processor
Cache Memory	1GB ~ 4GB DDR2-800 ECC Registered SDRAM
Battery Backup	Optional
Management Port support	Yes
RAID level	0, 1, 10(1E), 3, 5, 6, 30, 50, 60 and JBOD
Array Group	Up to 128
LUNs	Up to 128
Hot Spare	Yes
Drive Roaming	Yes
Online Rebuild	Yes
Variable Stripe Size	Yes
E-mail Notification	Yes
Online capacity expansion, RAID level /stripe size migration	Yes
Online Array roaming	Yes
Online consistency check	Yes
SMTP manager and SNMP agent	Yes
Redundant Flash image	Yes
Instant availability and background initialization	Yes
S.M.A.R.T. support	Yes
MAID (spin down idle drives)	Yes
Bad block auto-remapping	Yes
Platform	Rackmount
Form Factor	4U
# of Hot Swap Trays	42
Tray Lock	Yes
Disk Status Indicator	Access / Fail LED
Backplane	SAS / SATA Single BP
# of PS/Fan Modules	1100W x 2 w/PFC
# of Fans	11
Power requirements	AC 100V ~ 240V (+/-10%) Full Range 50Hz~60Hz
Relative Humidity	10% ~ 85% Non-condensing
Operating Temperature	10°C ~ 40°C (50°F ~ 104°F)
Physical Dimension	810(L) x 482.6(W) x 176(H) mm
Weight (Without Disk)	48.5 Kg

1.2 RAID Concepts

RAID Fundamentals

The basic idea of RAID (Redundant Array of Independent Disks) is to combine multiple inexpensive disk drives into an array of disk drives to obtain performance, capacity and reliability that exceeds that of a single large drive. The array of drives appears to the host computer as a single logical drive.

Five types of array architectures, RAID 1 through RAID 5, were originally defined; each provides disk fault-tolerance with different compromises in features and performance. In addition to these five redundant array architectures, it has become popular to refer to a non-redundant array of disk drives as a RAID 0 arrays.

Disk Striping

Fundamental to RAID technology is striping. This is a method of combining multiple drives into one logical storage unit. Striping partitions the storage space of each drive into stripes, which can be as small as one sector (512 bytes) or as large as several megabytes. These stripes are then interleaved in a rotating sequence, so that the combined space is composed alternately of stripes from each drive. The specific type of operating environment determines whether large or small stripes should be used.

Most operating systems today support concurrent disk I/O operations across multiple drives. However, in order to maximize throughput for the RAID Subsystem, the I/O load must be balanced across all the drives so that each drive can be kept busy as much as possible. In a multiple drive system without striping, the disk I/O load is never perfectly balanced. Some drives will contain data files that are frequently accessed and some drives will rarely be accessed.

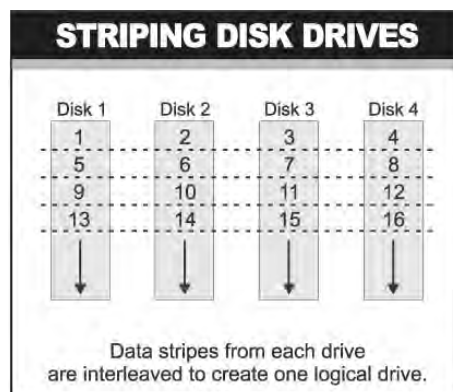

By striping the drives in the array with stripes large enough so that each record falls entirely within one stripe, most records can be evenly distributed across all drives. This keeps all drives in the array busy during heavy load situations. This situation allows all drives to work concurrently on different I/O operations, and thus maximize the number of simultaneous I/O operations that can be performed by the array.

Definition of RAID Levels

RAID 0 is typically defined as a group of striped disk drives without parity or data redundancy. RAID 0 arrays can be configured with large stripes for multi-user environments or small stripes for single-user systems that access long sequential records. RAID 0 arrays deliver the best data storage efficiency and performance of any array type. The disadvantage is that if one drive in a RAID 0 array fails, the entire array fails.

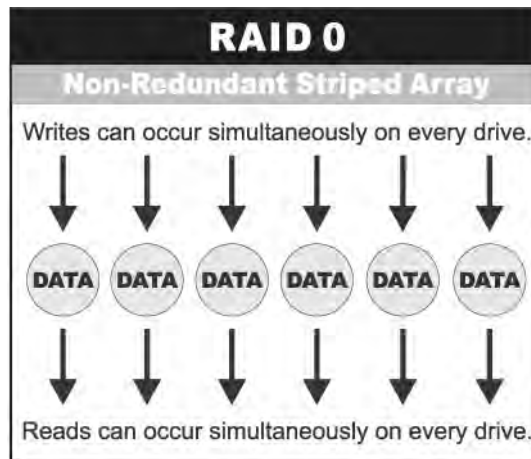

RAID 1, also known as disk mirroring, is simply a pair of disk drives that store duplicate data but appear to the computer as a single drive. Although striping is not used within a single mirrored drive pair, multiple RAID 1 arrays can be striped together to create a single large array consisting of pairs of mirrored drives. All writes must go to both drives of a mirrored pair so that the information on the drives is kept identical. However, each individual drive can perform simultaneous, independent read operations. Mirroring thus doubles the read performance of a single non-mirrored drive and while the write performance is unchanged. RAID 1 delivers the best performance of any redundant array type. In addition, there is less performance degradation during drive failure than in RAID 5 arrays.

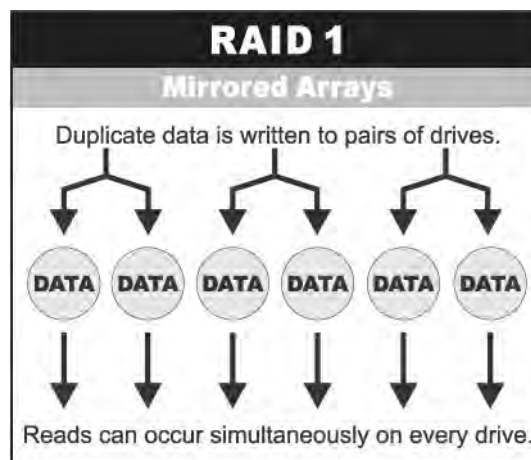

RAID 3 sector-stripes data across groups of drives, but one drive in the group is dedicated for storing parity information. RAID 3 relies on the embedded ECC in each sector for error detection. In the case of drive failure, data recovery is accomplished by calculating the exclusive OR (XOR) of the information recorded on the remaining drives. Records typically span all drives, which optimizes the disk transfer rate. Because each I/O request accesses every drive in the array, RAID 3 arrays can satisfy only one I/O request at a time. RAID 3 delivers the best performance for single-user, single-tasking environments with long records. Synchronized-spindle drives are required for RAID 3 arrays in order to avoid performance degradation with short records. RAID 5 arrays with small stripes can yield similar performance to RAID 3 arrays.

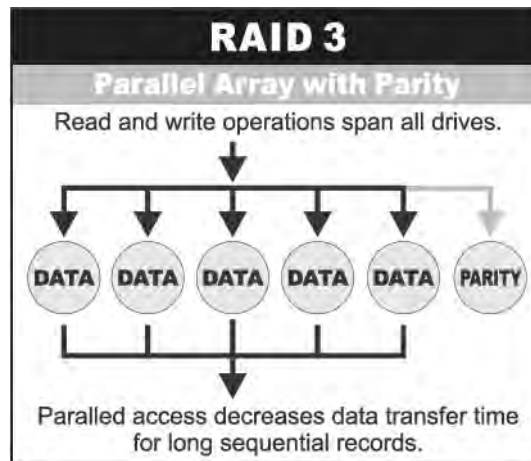

Under **RAID 5** parity information is distributed across all the drives. Since there is no dedicated parity drive, all drives contain data and read operations can be overlapped on every drive in the array. Write operations will typically access one data drive and one parity drive. However, because different records store their parity on different drives, write operations can usually be overlapped.

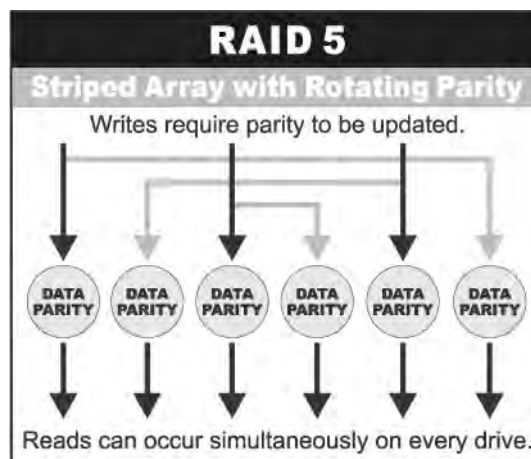

Dual-level RAID achieves a balance between the increased data availability inherent in RAID 1, RAID 3, RAID 5, or RAID 6 and the increased read performance inherent in disk striping (RAID 0). These arrays are sometimes referred to as RAID 10(1E), RAID 30, RAID 50 or RAID 60.

RAID 6 is similar to RAID 5 in that data protection is achieved by writing parity information to the physical drives in the array. With RAID 6, however, *two* sets of parity data are used. These two sets are different, and each set occupies a capacity equivalent to that of one of the constituent drives. The main advantage of RAID 6 is High data availability – any two drives can fail without loss of critical data.

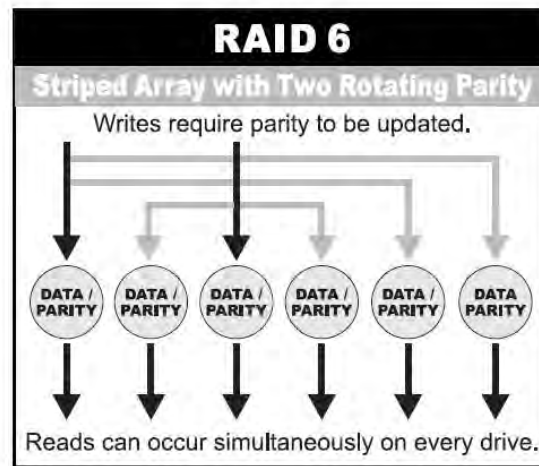

In summary:

- RAID 0 is the fastest and most efficient array type but offers no fault-tolerance. RAID 0 requires a minimum of one drive.
- RAID 1 is the best choice for performance-critical, fault-tolerant environments. RAID 1 is the only choice for fault-tolerance if no more than two drives are used.
- RAID 3 can be used to speed up data transfer and provide fault-tolerance in single-user environments that access long sequential records. However, RAID 3 does not allow overlapping of multiple I/O operations and requires synchronized-spindle drives to avoid performance degradation with short records. RAID 5 with a small stripe size offers similar performance.
- RAID 5 combines efficient, fault-tolerant data storage with good performance characteristics. However, write performance and performance during drive failure is slower than with RAID 1. Rebuild operations also require more time than with RAID 1 because parity information is also reconstructed. At least three drives are required for RAID 5 arrays.
- RAID 6 is essentially an extension of RAID level 5 which allows for additional fault tolerance by using a second independent distributed parity scheme (two-dimensional parity). Data is striped on a block level across a set of drives, just like in RAID 5, and a second set of parity is calculated and written across all the drives; RAID 6 provides for an extremely high data fault tolerance and can sustain multiple simultaneous drive failures. It is a perfect solution for mission critical applications.

RAID Management

The subsystem can implement several different levels of RAID technology. RAID levels supported by the subsystem are shown below.

RAID Level	Description	Min. Drives
0	Block striping is provide, which yields higher performance than with individual drives. There is no redundancy.	1
1	Drives are paired and mirrored. All data is 100% duplicated on an equivalent drive. Fully redundant.	2
3	Data is striped across several physical drives. Parity protection is used for data redundancy.	3
5	Data is striped across several physical drives. Parity protection is used for data redundancy.	3
6	Data is striped across several physical drives. Parity protection is used for data redundancy. Requires N+2 drives to implement because of two-dimensional parity scheme.	4
10(1E)	Combination of RAID levels 1 and 0 (1E or Enhanced Mirroring). This level provides striping and redundancy through mirroring. RAID 1E uses an <u>odd number</u> of disk drives to achieve data protection.	3
10	Combination of RAID levels 1 and 0. This level provides striping and redundancy through mirroring. RAID 0+1 requires the use of an <u>even number</u> of disk drives to achieve data protection.	4
30	Combination of RAID levels 0 and 3. This level is best implemented on two RAID 3 RAID Subsystems with data striped across both disk arrays.	6
50	RAID 50 provides the features of both RAID 0 and RAID 5. RAID 50 includes both parity and disk striping across multiple drives. RAID 50 is best implemented on two RAID 5 RAID Subsystems with data striped across both disk arrays.	6
60	RAID 60 combines both RAID 6 and RAID 0 features. Data is striped across disks as in RAID 0, and it uses double distributed parity as in RAID 6. RAID 60 provides data reliability, good overall performance and supports larger volume sizes. RAID 60 also provides very high reliability because data is still available even if multiple disk drives fail (two in each disk arrays).	8

1.3 Array Definition

1.3.1 RAID Set

A RAID Set is a group of disk drives containing one or more logical volumes called Volume Sets. It is not possible to have multiple RAID Sets on the same disk drives.

A Volume Set must be created either on an existing RAID Set or on a group of available individual disk drives (disk drives that are not yet a part of a RAID Set). If there are existing RAID Sets with available raw capacity, new Volume Set can be created. New Volume Set can also be created on an existing RAID Set without free raw capacity by expanding the RAID Set using available disk drive(s) which is/are not yet RAID Set member. If disk drives of different capacity are grouped together in a RAID Set, then the capacity of the smallest disk will become the effective capacity of all the disks in the RAID Set.

1.3.2 Volume Set

A Volume Set is seen by the host system as a single logical device. It is organized in a RAID level with one or more physical disks. RAID level refers to the level of data performance and protection of a Volume Set. A Volume Set capacity can consume all or a portion of the raw capacity available in a RAID Set. Multiple Volume Sets can exist on a group of disks in a RAID Set. Additional Volume Sets created in a specified RAID Set will reside on all the physical disks in the RAID Set. Thus each Volume Set on the RAID Set will have its data spread evenly across all the disks in the RAID Set. Volume Sets of different RAID levels may coexist on the same RAID Set.

In the illustration below, Volume 1 can be assigned a RAID 5 level while Volume 0 might be assigned a RAID 10 level.

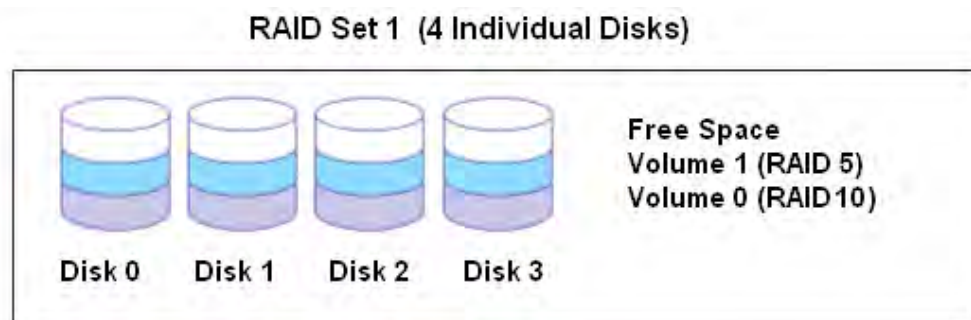

1.4 High Availability

1.4.1 Creating Hot Spares

A hot spare drive is an unused online available drive, which is ready to replace a failed disk drive. In a RAID level 1, 10, 3, 5, 6, 30, 50, or 60 RAID Set, any unused online available drive installed but not belonging to a RAID Set can be defined as a hot spare drive. Hot spares permit you to replace failed drives without powering down the system. When the RAID Subsystem detects a drive failure, the system will do automatic and transparent rebuild using the hot spare drives. The RAID Set will be reconfigured and rebuilt in the background while the RAID Subsystem continues to handle system request. During the automatic rebuild process, system activity will continue as normal, however, the system performance and fault tolerance will be affected.



IMPORTANT: The hot spare must have at least the same or more capacity as the drive it replaces.

1.4.2 Hot-Swap Disk Drive Support

The RAID Subsystem has built-in protection circuit to support the replacement of SATA hard disk drives without having to shut down or reboot the system. The removable hard drive tray can deliver “hot swappable” fault-tolerant RAID solution at a price much less than the cost of conventional SCSI hard disk RAID arrays. This feature is provided in the RAID Subsystem for advance fault tolerant RAID protection and “online” drive replacement.

1.4.3 Hot-Swap Disk Rebuild

The Hot-Swap feature can be used to rebuild RAID Sets with data redundancy such as RAID level 1, 10, 3, 5, 6, 30, 50 and 60. If a hot spare is not available, the failed disk drive must be replaced with a new disk drive so that the data on the failed drive can be rebuilt. If a hot spare is available, the rebuild starts automatically when a drive fails. The RAID Subsystem automatically and transparently rebuilds failed drives in the background with user-definable rebuild rates. The RAID Subsystem will automatically continue the rebuild process if the subsystem is shut down or powered off abnormally during a reconstruction process.

Chapter 2 Identifying Parts of the RAID Subsystem

2.1 Main Components

2.1.1 Front View

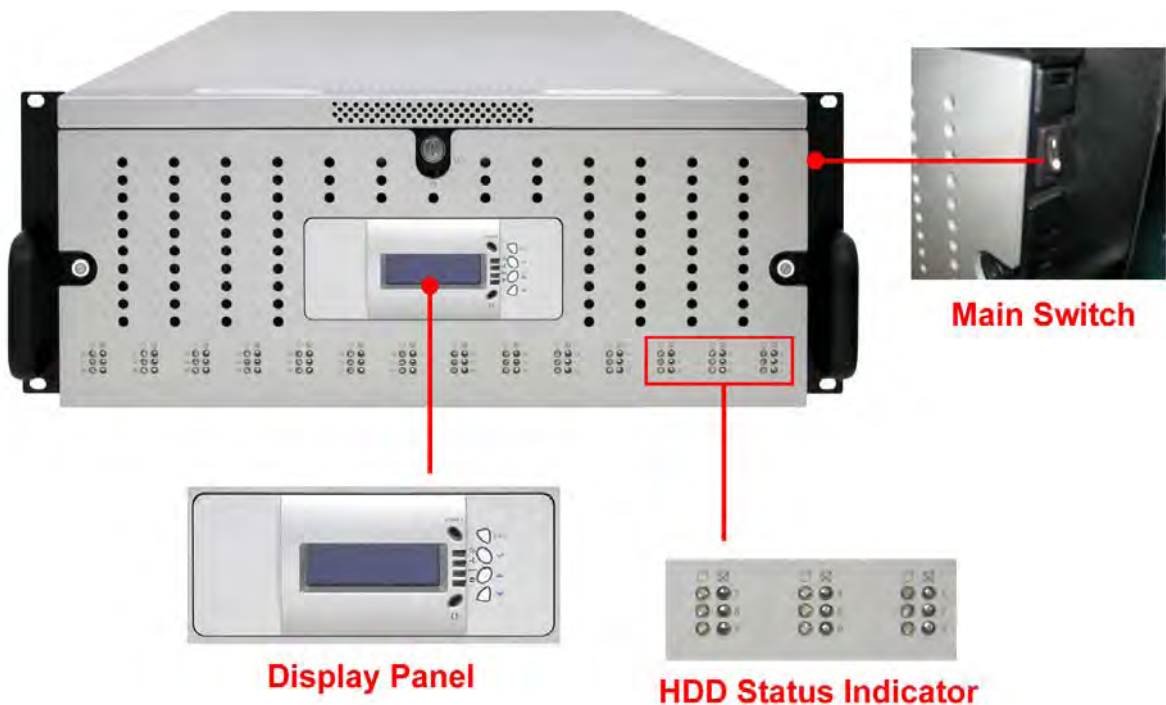

IMPORTANT: When powering off the RAID subsystem, turn off first the Main Switch and allow at least 3 minutes (during which each disk slot starting from slot #1 until slot #42 will be powered down) for the subsystem to shutdown properly. Then turn off the switches of the 2 Power Supply Fan Modules.

2.1.2 Rear View

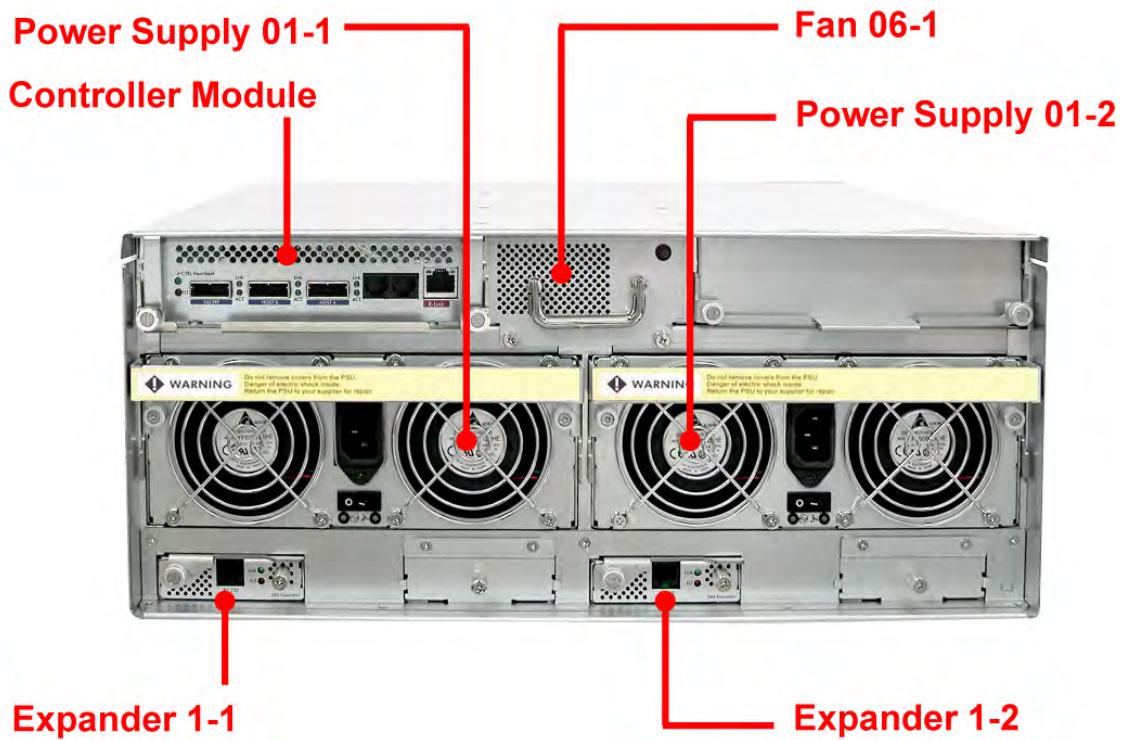

NOTE: Each Power Supply Module has 1 Power Supply and 5 Fans. For purpose of hardware monitoring, the RAID enclosure is logically divided into two enclosures.

The functions of the Expander Modules are as follows:

Module:	Function/Description:
Expander Module 1-1	Monitors Enclosure 1 (Disk slots 1 to 21, Power Supply 01-1, Fans 01-1, 02-1, 03-1, 04-1, and 05-1, and Turbo Fan 06-1). Note: "-1" means enclosure 1.
Expander Module 1-2	Monitors Enclosure 2 (Disk slots 22 to 42, Power Supply 01-2, Fans 01-2, 02-2, 03-2, 04-2, and 05-2). Note: "-2" means enclosure 2.

2.2 Controller Module

The RAID Subsystem includes 6Gb SAS-to-SAS/SATA RAID Controller Module.



RAID Controller Module

2.2.1 Controller Module Panel

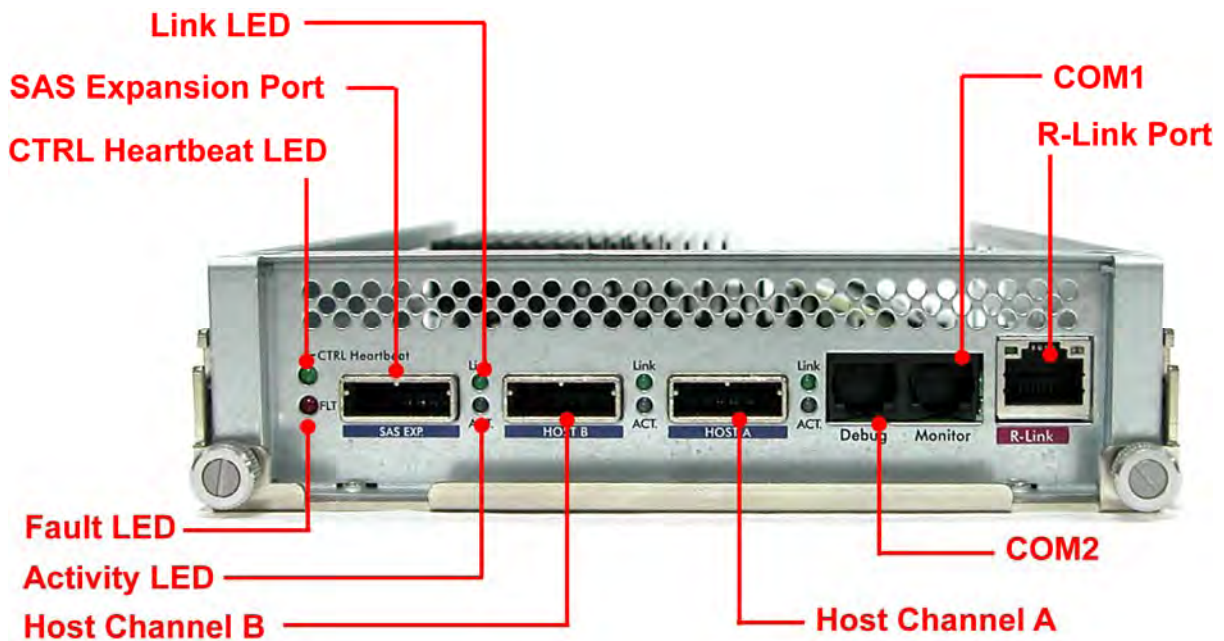

Note: Only one host cable is included in the package. Additional host cables are optional and can be purchased separately for upgrade.

Part	Description
Host Channel A, B	Two host channels (A and B) are available and can be use to connect to SAS HBA on the Host system, or to connect to SAS switch.
SAS Expansion Ports 1, 2	Use for expansion; connect to the SAS In Port of a JBOD subsystem.
COM2	Use to connect to CLI (command line interface) for example to upgrade expander firmware. See section <i>6.3 Upgrading the Expander Firmware</i> .
COM1	Use to check controller debug messages
R-Link Port	Use to manage the RAID subsystem via network and web browser.

Indicator LED	Color	Description
Link LED	Green	Indicates Host Channel has connected or linked.
	Blue	Indicates the Host Channel is busy and being accessed.
Activity LED	Green	Indicates expander has connected or linked.
	Blue	Indicates the expander is busy and being accessed.
Fault LED	Blink RED	Indicates that controller has failed.
CTRL Heartbeat LED	Blink Green	Indicates that controller is working fine.
	Solid Green	Indicates that controller is hung.

2.3 Power Supply / Fan Module (PSFM)

The 42bay RAID Subsystem contains **two 1100W Power Supply/Fan Modules**. All PSFM are inserted at the rear of the chassis.



[Front Panel](#)



[Rear Side](#)



NOTE: Each PSFM delivers Full-Range 100V ~ 240V (+/-10%) voltage AC electricity. Each PSFM consists of 1 power supply and 5 fans. Two Fans are located at the panel side, and three fans are located in rear side of the PSFM.

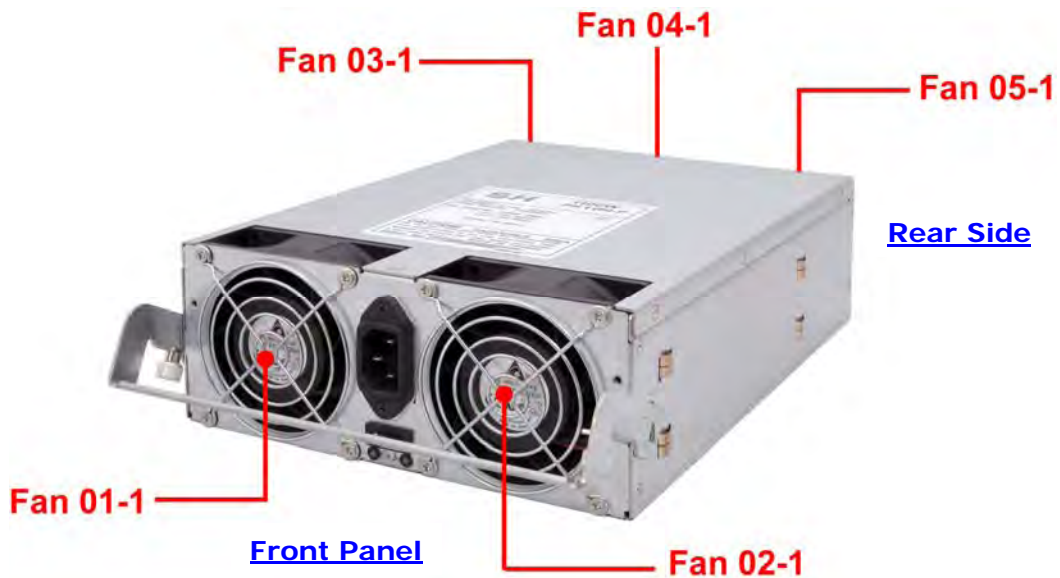
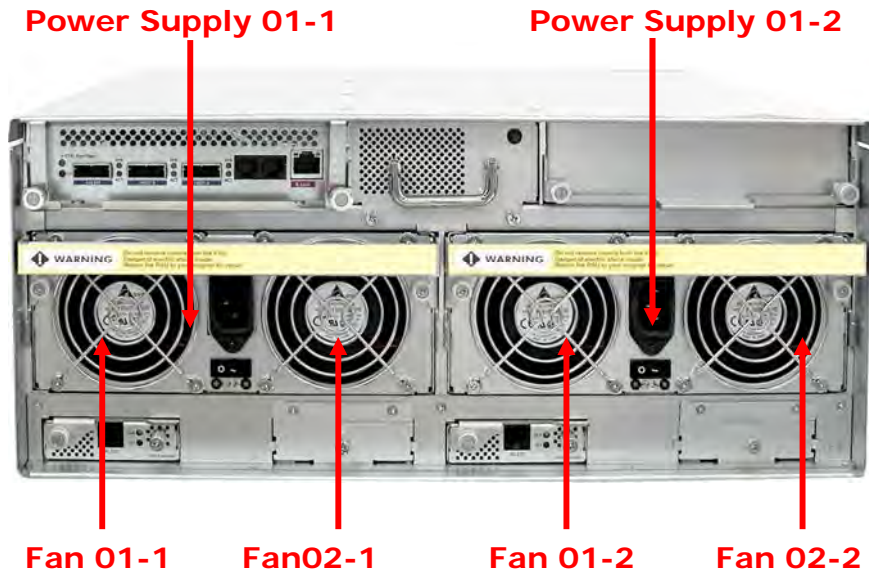

NOTE: The first PSFM (01-1, on the left side of enclosure) has five fans: Fan 01-1 and Fan 02-1 on the front panel; and Fan 03-1, Fan 04-1 and Fan 05-1 on the rear side.

The second PSFM (01-2, on the right side) has five fans also: Fan 01-2 and Fan 02-2 on the front panel; and Fan 03-2, Fan 04-2 and Fan 05-2 on the rear side.



NOTE: "-1" means enclosure 1 and "-2" means enclosure 2.

2.3.1 PSFM Panel

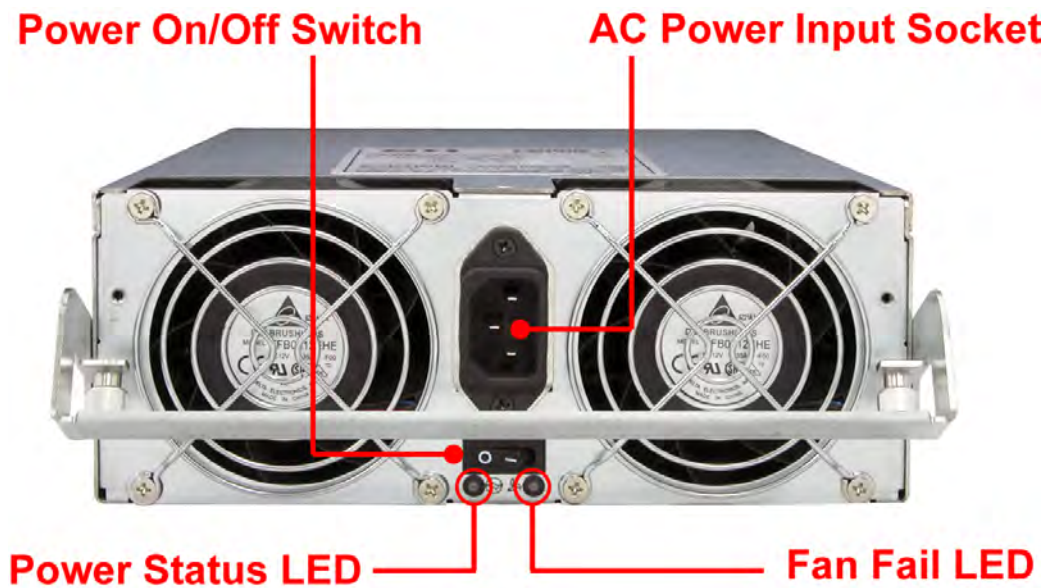

Part	Description
AC Power Input Socket	Use to connect the power cord from power source.
Power On/Off Switch	Use to power on or power off the PSFM.

Indicator	Color	Description
Power Status LED	Green	Indicates the power supply module is good.
	Red	Indicates the power supply module is faulty.
Fan Fail LED	Red	Indicates one or more fans in the PSFM has failed.

When the power cord connected from main power source is inserted to the AC Power Input Socket the Power Status LED becomes **RED**. When the switch of the PSFM is turned on, the LED still shows **RED**. After the main switch in front panel is turned on, the LED turns **GREEN**, which means it is functioning normally.

The PSFM has a **5V standby** DC voltage. When the power cord(s) is/are connected to the AC Power Input Socket, after 1 second, all 42 Activity LEDs will flash once. When the power cord(s) is/are disconnected from AC Power Input Socket, after 3 seconds, all 42 Activity LEDs will flash twice.

2.4 Turbo Fan (Fan 06-1)

The turbo fan provides additional airflow inside the enclosure.



Turbo Fan LED



Indicator	Color	Description
Status LED	Red	Indicates the turbo fan is faulty.



NOTE: The status of Turbo Fan (Fan 06-1) is monitored by Expander Module 1.

2.5 Expander Module

The Expander Module contains the SAS expander. It can be used to upgrade the SAS expander firmware. It also contains the SES module (SCSI Enclosure Services). SES is the protocol used for enclosure environmental control.



The SES module monitors the following enclosure conditions: temperature, power supply voltage, and fan speed.

2.5.1 Expander Module Panel



Part	Description
RS-232 Port	Use to upgrade the firmware of the expander module. Connect the serial cable RJ11-to-DB9 to your system's serial port.

Indicator	Color	Description
Activity LED	Blinking Green	Indicates the expander module is busy or active.
Fault LED	Blinking Red	Indicates the expander module is faulty or has failed.

2.6 Disk Tray

The Disk Tray houses a 3.5 inch hard disk drive. It is designed for maximum airflow and incorporates a carrier locking mechanism to prevent unauthorized access to the HDD.



Disk Tray Lock



Unlocked



Locked

Key for Disk Tray Lock



2.6.1 Disk Drive Status LEDs

The Front Panel shows the disk drives status.

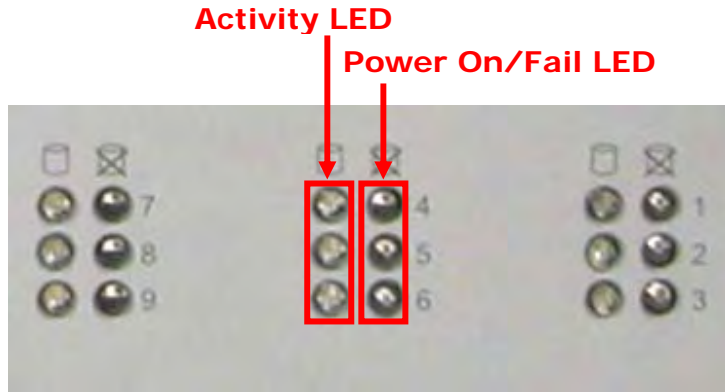

Indicator	Color	Description
Activity LED	Blue Blinking	Indicates the disk drive is busy or being accessed.
Power On/Fail LED	Green	Indicates the disk drive in this slot is good.
	RED	Indicates the disk drive in this slot is defective or failed.
	LED is off	Indicates there is no disk drive in this slot.

2.6.2 Disk Drive Installation

This section describes the physical locations of the hard drives supported by the subsystem and give instructions on installing a hard drive. The subsystem supports hot-swapping allowing you to install or replace a hard drive while the subsystem is running.



NOTE: When the RAID subsystem is shipped, the disk trays are not placed in the disk slots. If all disk trays will be used to install all 42 disk drives, for quicker and easier installation of disk drives in the RAID subsystem, it is recommended to install first each disk drive in a disk tray. After installing the disk drives, insert 14 disk trays into one row of 14 slots at a time and lock them one by one. Do the same for the next row until the last row.

Disk Slots

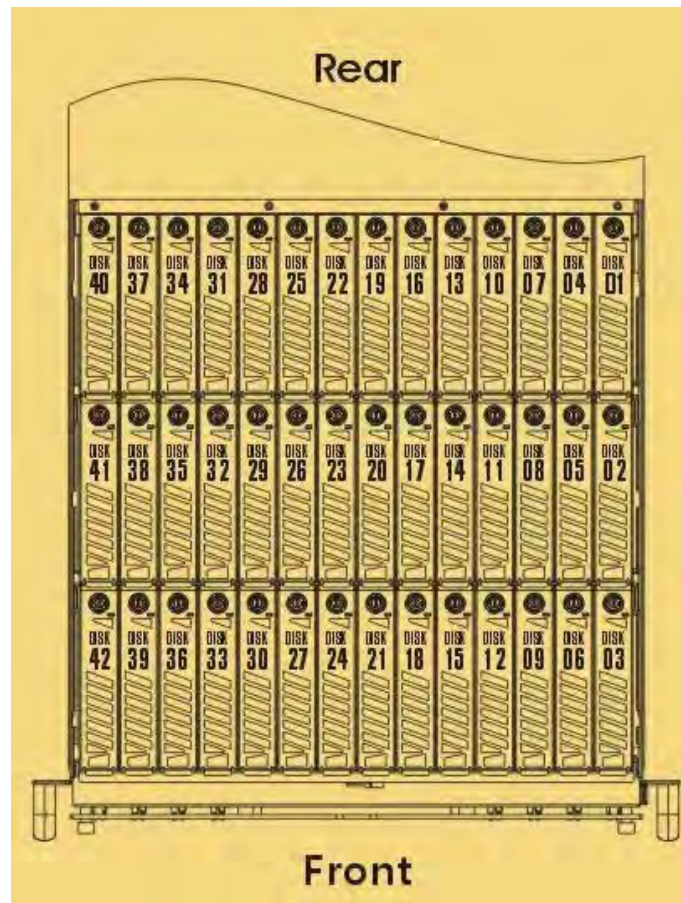

NOTE: When the subsystem is already in operational mode, it is not recommended to open the top cover for a long period of time; proper air flow within the enclosure might fail causing high disk drive temperature.

To install a SAS disk drive or SATA disk drive in a disk tray:

1. Use the Key for Disk Tray Lock to unlock a disk tray.



2. Place the disk drive into the disk tray.
3. Turn the disk tray upside down. To secure the disk drive into the disk tray, tighten 4 screws on the holes of the disk tray. Note in the picture below where the screws should be placed in the disk tray holes.

4 screws  #6-32 UNC L=5.0mm



To install the disk trays into the disk slots:

- a. Loosen two screws on both sides of the top cover on the front panel side.



- b. Use the Top Cover Key to unlock the key lock on the front panel side.

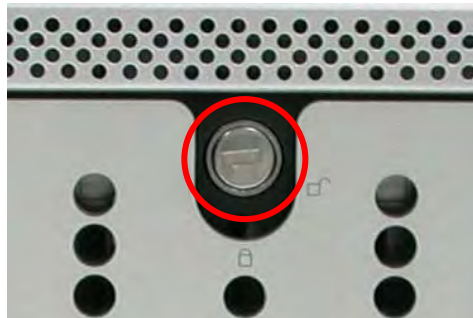

- c. Hold the front part of the top cover and slide the top cover about half an inch towards the front side then pull upwards to remove it.



- d. Insert each disk tray with disk drive one by one, 14 disk trays or one row first, and then lock each disk tray. Then do the same for the next 14 disk trays or row.

To install the disk tray into the disk slot, insert it first in the slot.

Then push down the latch part of disk tray as indicated in the picture below until it reached a full stop.

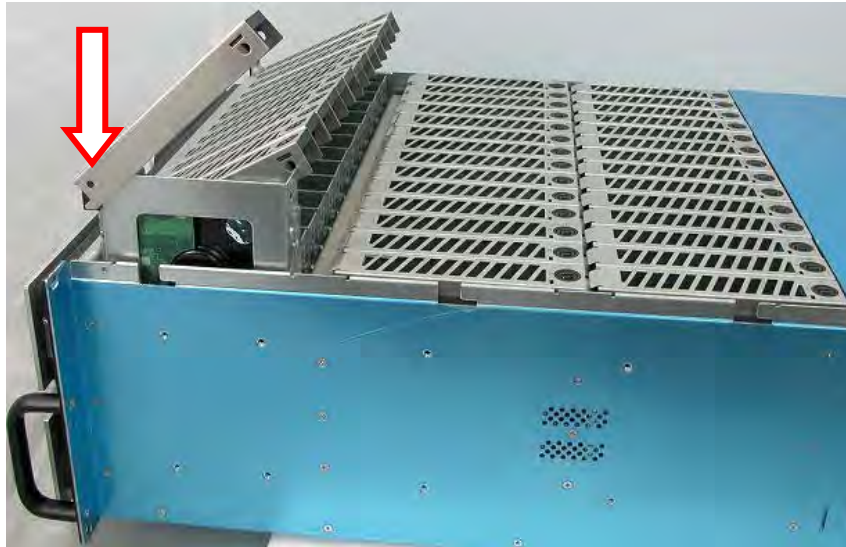

Close the lever handle then use the Key for Disk Tray Lock and turn the disk tray lock into "locked" position.



- e. When all disk trays have been installed and locked, put the top cover back and place it about half an inch away. Then push the top cover towards the rear.



- f. Use the Top Cover Key to lock the key lock on the front panel side.

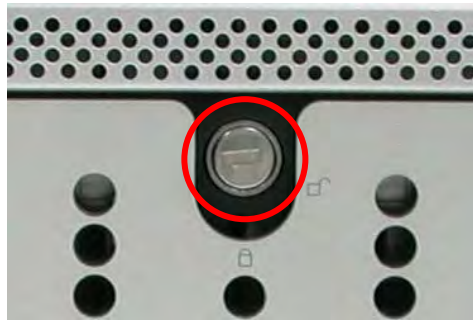

- g. To secure the top cover, tighten two screws on both sides of the top cover on the front panel side.



2.7 LCD Display Panel

2.7.1 LCD Display Panel LEDs

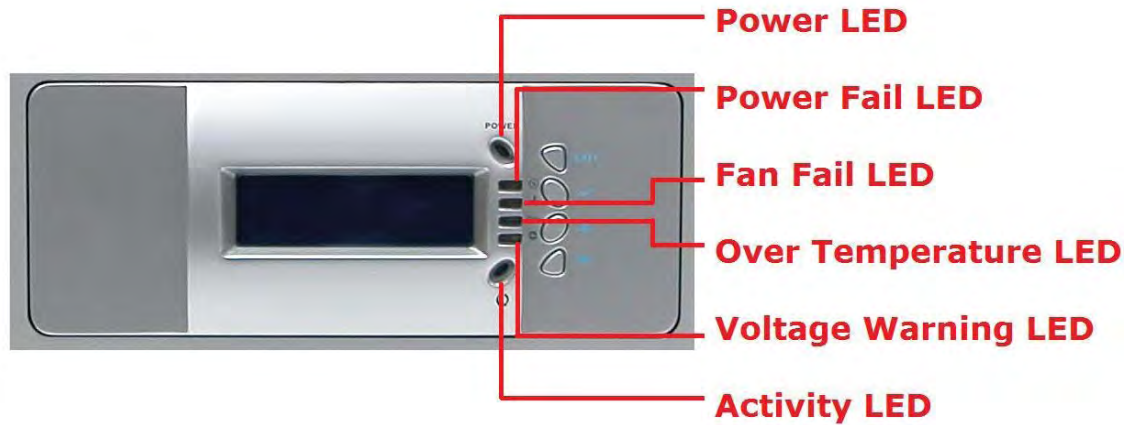



Environmental Status

Parts	Function
Power LED	Green indicates power is ON.
Power Fail LED	If one of the redundant power supply unit fails, this LED will turn to RED and alarm will sound.
Fan Fail LED	When a fan's rotation speed is lower than 1500rpm, this LED will turn red and an alarm will sound.
Over Temperature LED	If temperature irregularities in the system occur (HDD slot temperature over 65°C, Controller temperature over 70°C, CPU Temperature over 90°C), this LED will turn RED and alarm will sound.
Voltage Warning LED	If the output DC voltage is above or below the allowed range, an alarm will sound warning of a voltage abnormality and this LED will turn red. 12V: over 12.8V / under 11.12V 5V: over 5.35V / under 4.63V 3.3V: over 3.53V / under 3.05V 1.2V: over 1.28V / under 1.12V
Activity LED	This LED will blink blue when the RAID Subsystem is busy or active.

Front Panel Function Buttons

If you want to configure or view settings of the RAID Subsystem using the LCD panel, please press the Select button.

Parts	Function
Up and Down Arrow buttons 	Use the Up or Down arrow keys to go through the information on the LCD screen. This is also used to move between each menu when you configure or view information in the subsystem.
Select button 	This is used to enter the option you have selected.
Exit button EXIT	Press this button to return to the previous menu. NOTE: This button can also be used to reset the alarm beeper. For example, if one disk drive fails, pressing this button will mute the beeper.

Chapter 3 Getting Started with the Subsystem

This chapter contains information about the steps needed to start using the subsystem. If the subsystem will be installed in a rackmount cabinet, follow the steps in Section 3.1, otherwise, proceed with Section 3.2.

3.1 Installing the Rails and Mounting into Rack



NOTE: At least two persons are needed to lift the subsystem. To reduce the weight of the subsystem, remove the 2 power supply modules from the rear of subsystem. If disk drives are already installed in the disk trays, remove also the disk trays. Refer to appropriate sections on how to remove the power supply modules and how to remove the disk trays/disk drives.



NOTE: The subsystem must be installed near the Disk Array or host system where it will be connected. A Phillips screwdriver is needed in installation.



WARNING! It is prohibited to put other enclosures/subsystems on top of the 42-bay subsystem because the total weight will not be supported by the rails.

Steps:

1. Open the rail box.
2. Remove the 2 rail assemblies and the screws/accessories from the box. Check its contents.



3. Insert two (2) M5 nuts on the 2 holes of the front left side of the rack post.

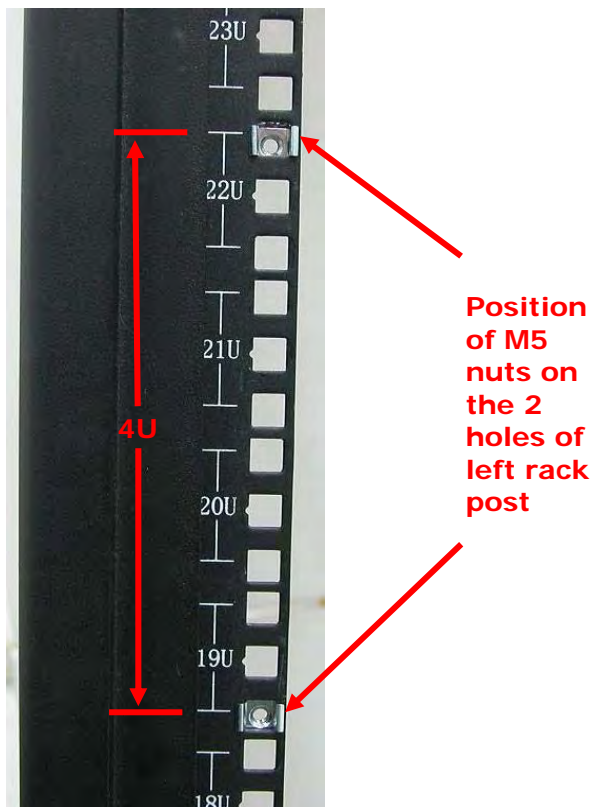

Rack Post – Front Left Side

4. Insert two (2) M5 nuts on the 2 holes of the front right side of the rack post.

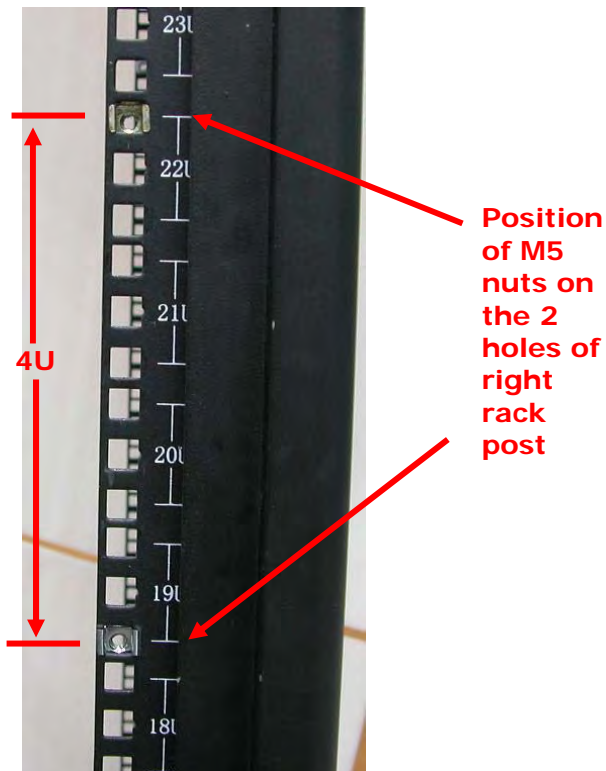

Rack Post – Front Right Side

5. Prepare the 2 rail assemblies.

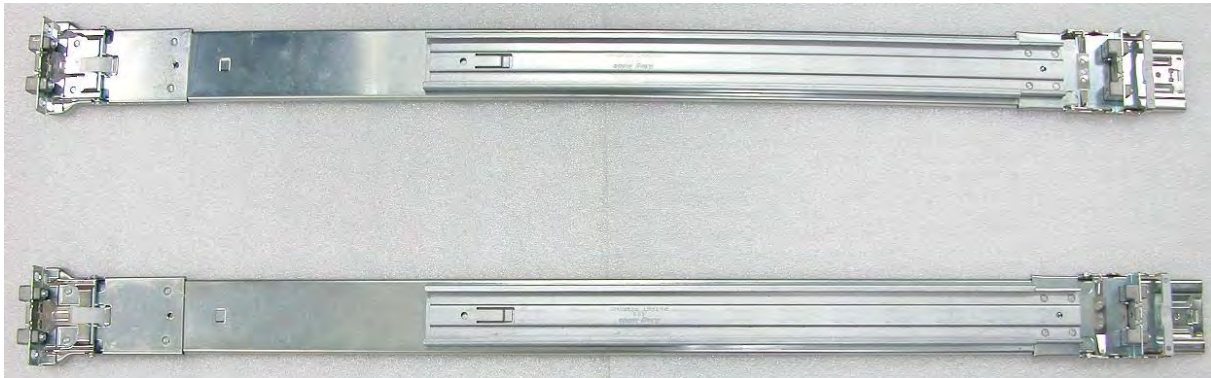

Front Side of Rail Assembly

Rear Side of Rail Assembly

6. Hold one rail assembly and install in the front left side of rack. To install, align and insert the 2 latches of the rail into the 2 holes on the rack post. Use the Lock Lever to lock the rail assembly in the left rack post.

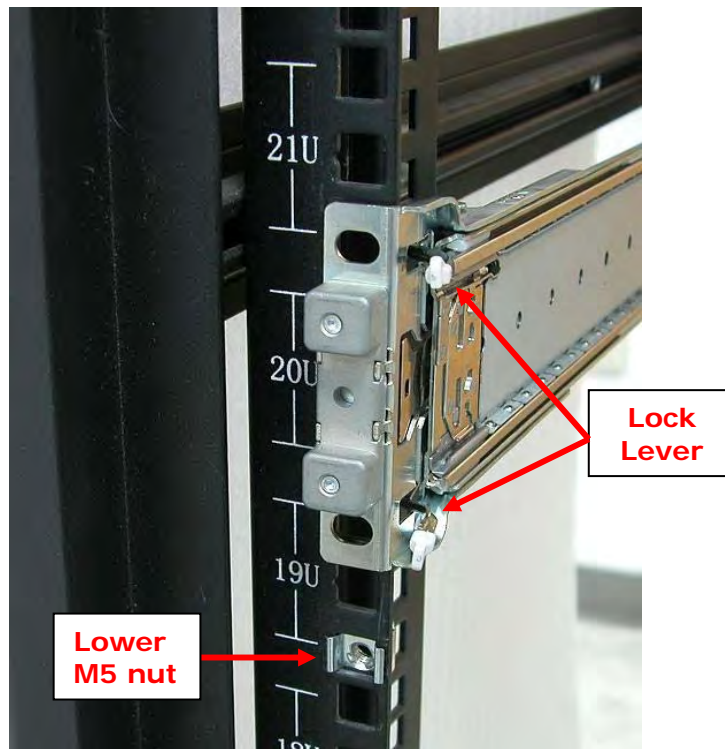

**View from Front Side of Front Left Rack Post
Lock Lever is Not Locked**

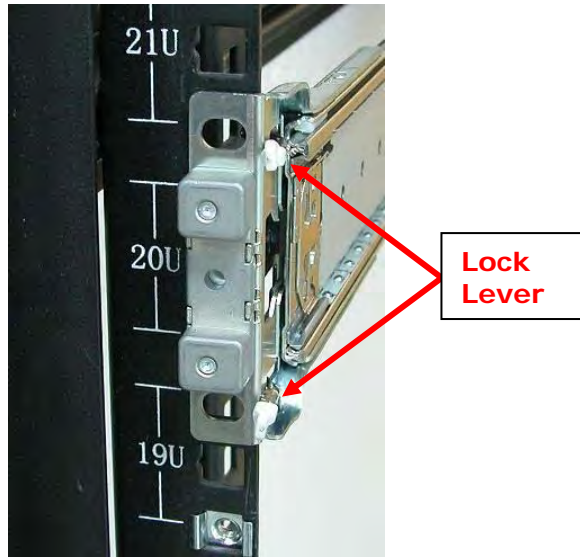

**View from Front Side of Front Left Rack Post
Lock Lever is Locked**

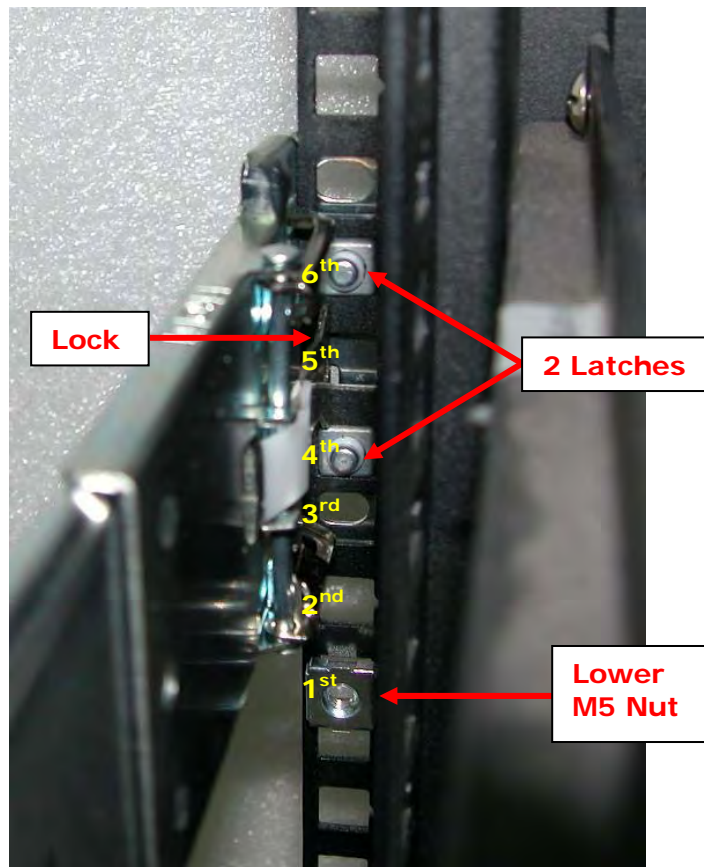

**View from Rear Side of Front Left Rack Post
2 Latches are inserted in the 4th and 6th holes from bottom (M5 nut)**

7. Install the other end of rail assembly to the left rear side. Align and insert the 2 latches on the 2 holes on the rear rack post, and then push the rail a little towards the rear side and lock the lock lever on the rack post.

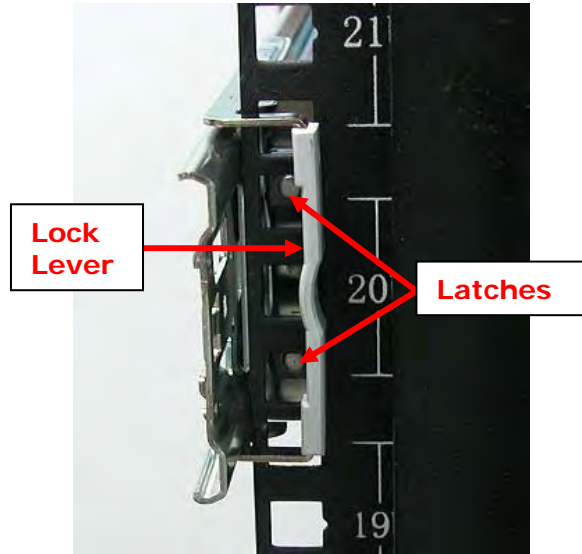

View from Rear Side of Rear Left Rack Post

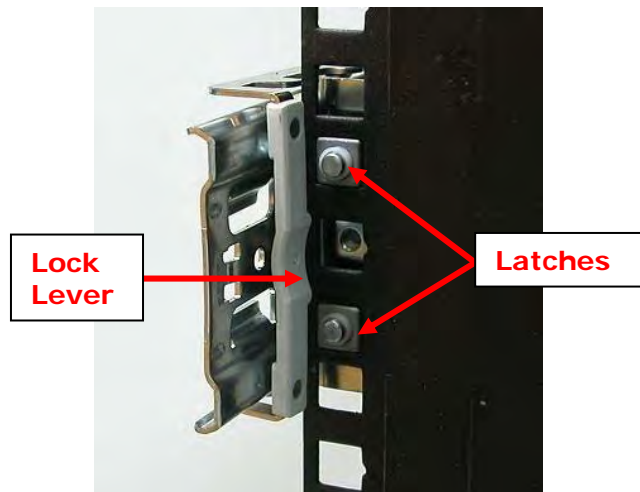

View from Rear Side of Rear Left Rack Post

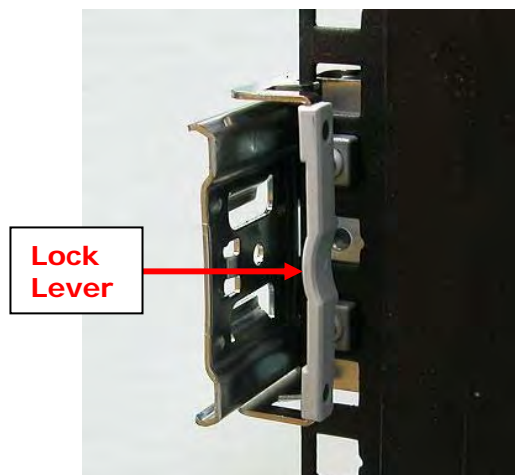

View from Rear Side of Rear Left Rack Post

8. Repeat step 6 to install the other rail assembly into the right front side.

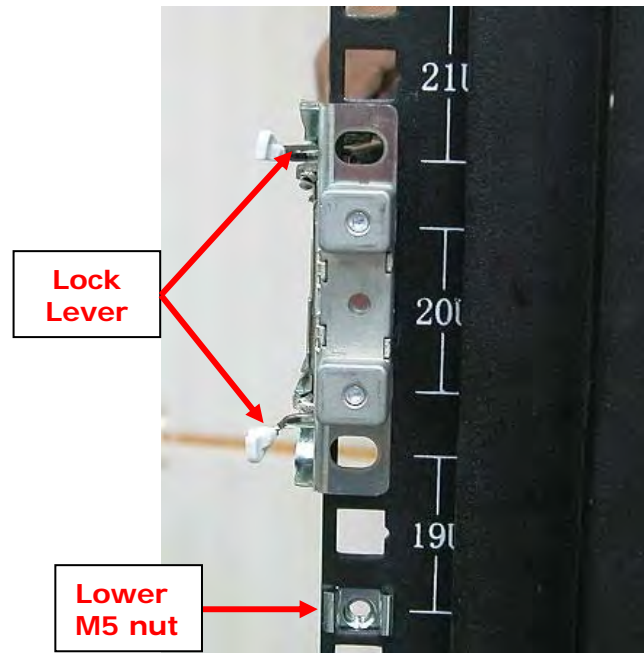

**View from Front Side of Front Right Rack Post
Lock Lever is Not Locked**

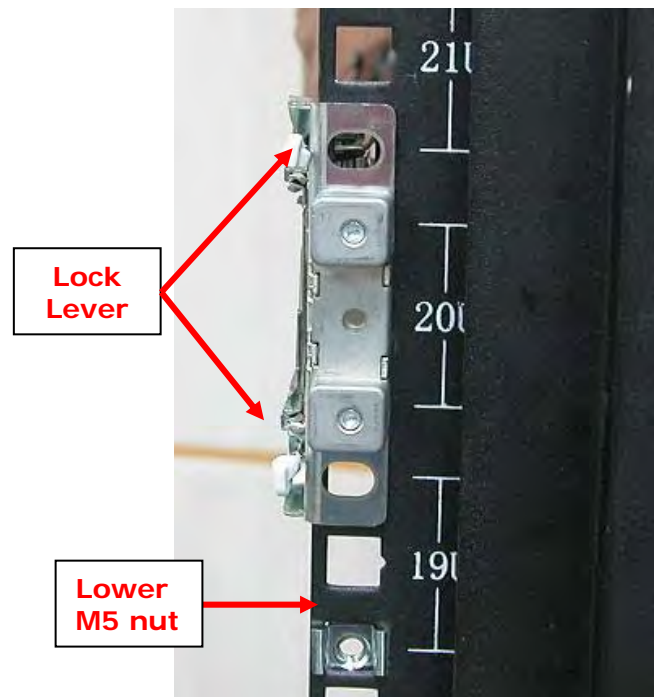

**View from Front Side of Front Right Rack Post
Lock Lever is Locked**

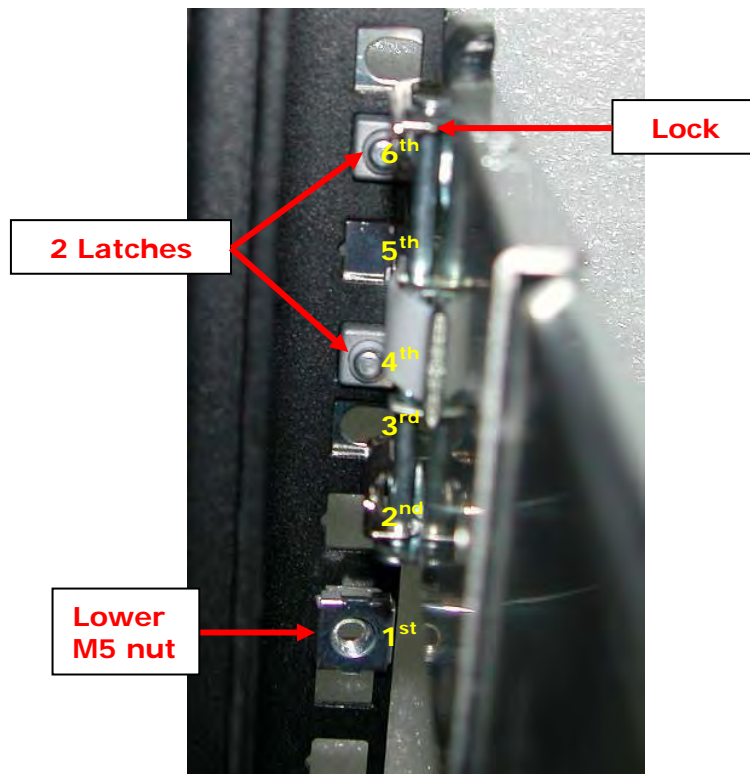

View from Rear Side of Front Right Rack Post
2 Latches are inserted in the 4th and 6th holes from bottom (M5 nut)

9. Repeat step 7 to install the other end of rail assembly to the rack post of rear right side.

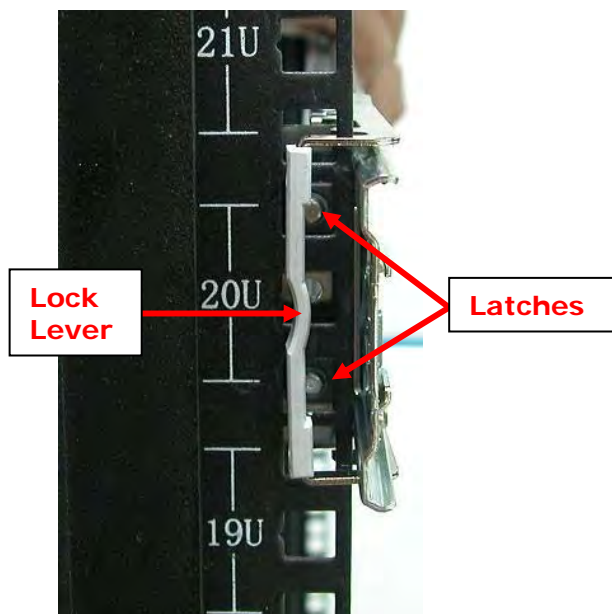

View from Rear Side of Rear Right Rack Post

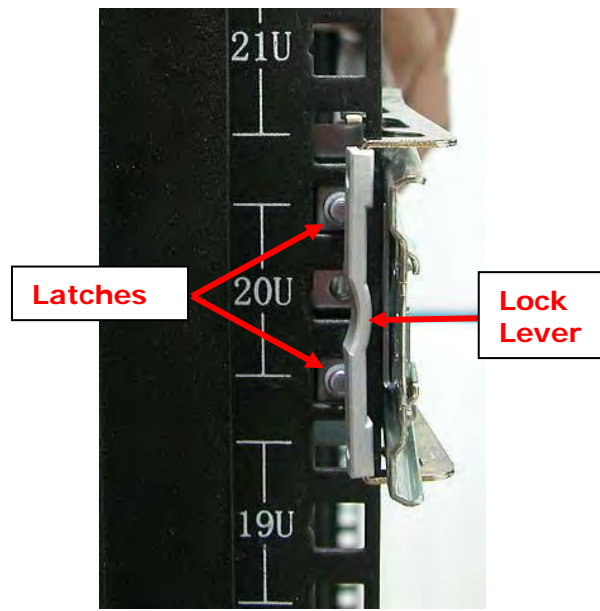

View from Rear Side of Rear Right Rack Post

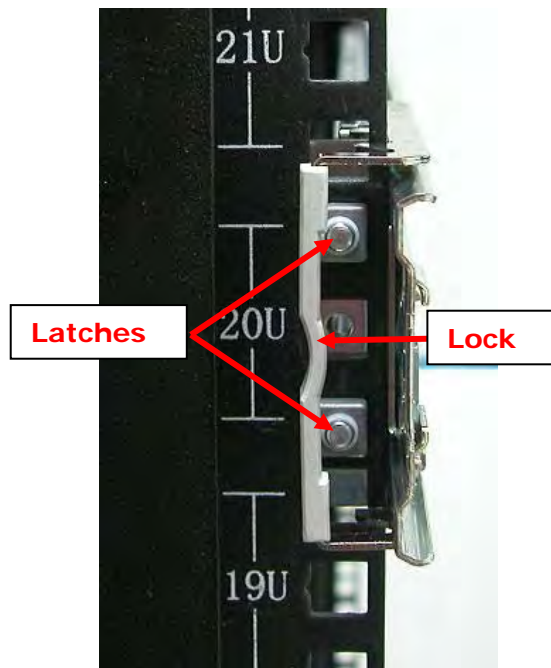

View from Rear Side of Rear Right Rack Post

10. Install the inner rail member on the side of the enclosure. Align the holes on the inner rail then slide a little towards the front side until locked.



Inner Rail Member

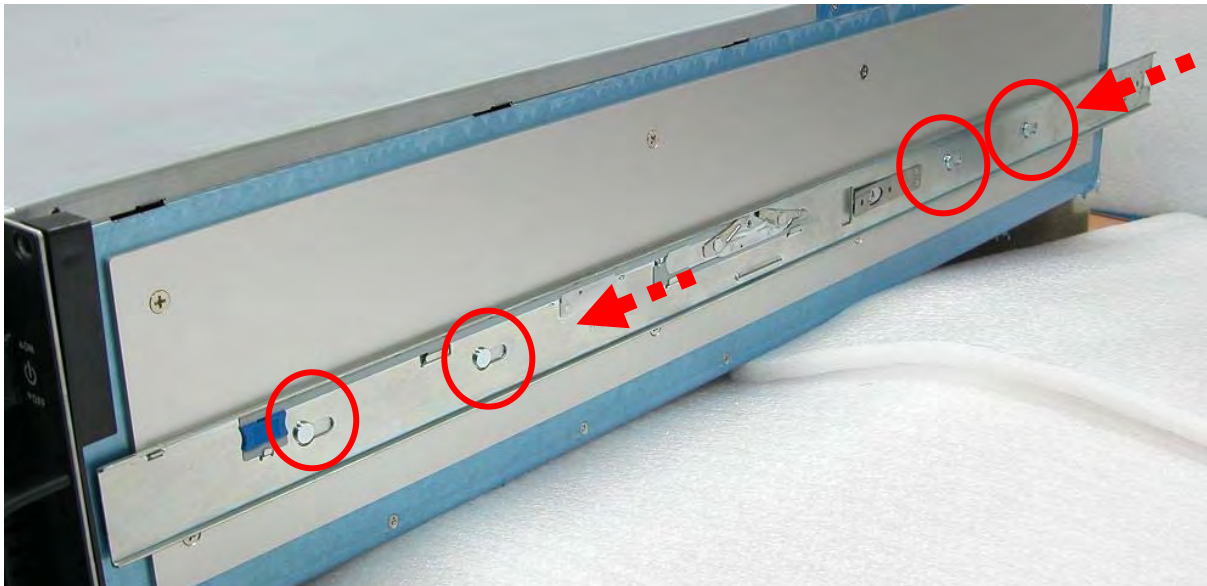

Inner Rail Member Placed on the Side of Enclosure

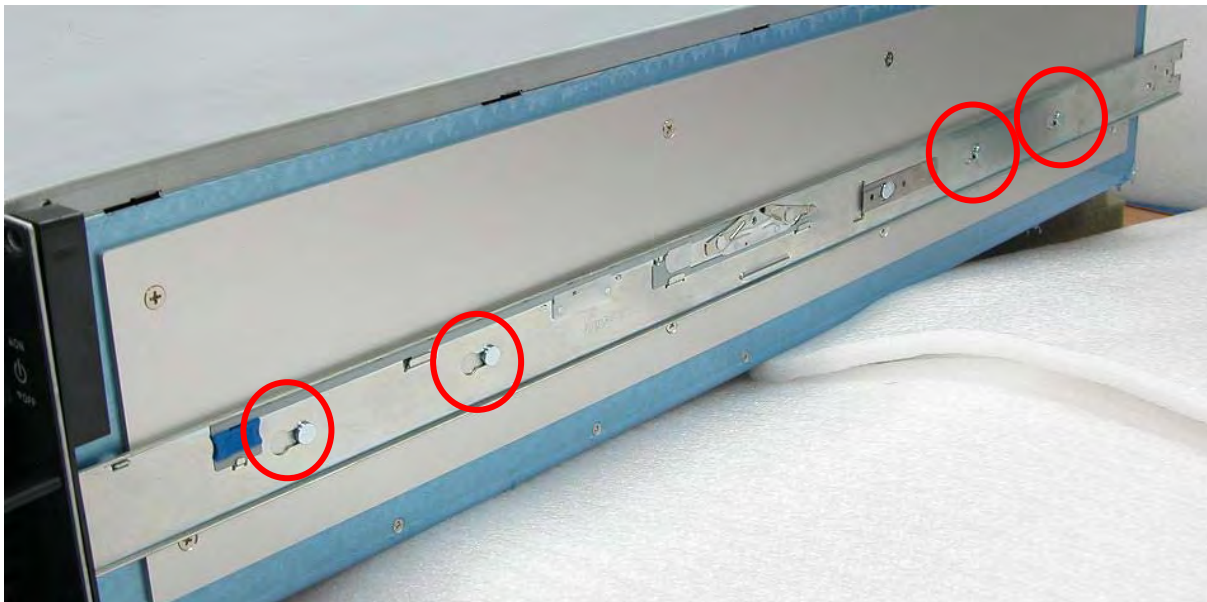

Inner Rail Member Pushed Towards the Front Side and Locked

11. Repeat step 10. Insert the other inner rail member on the other side of enclosure.

12. Pull the 2 middle rail members out from the rail assembly.

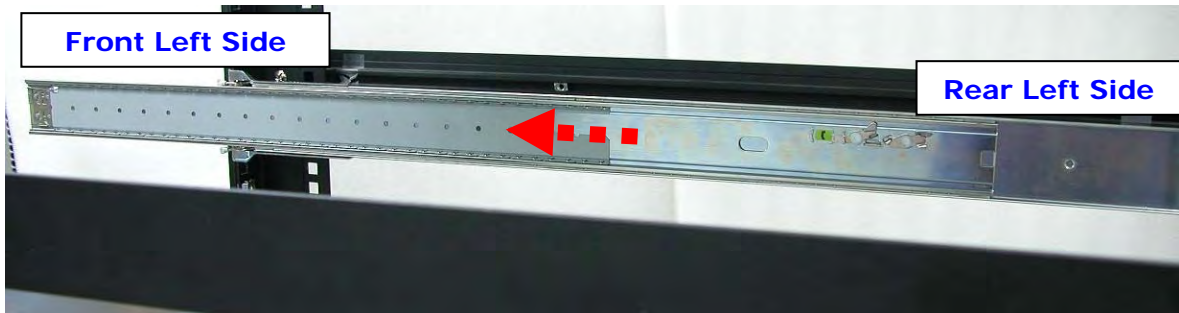

Middle Rail Member of Rail Assembly on Left Side of Rack

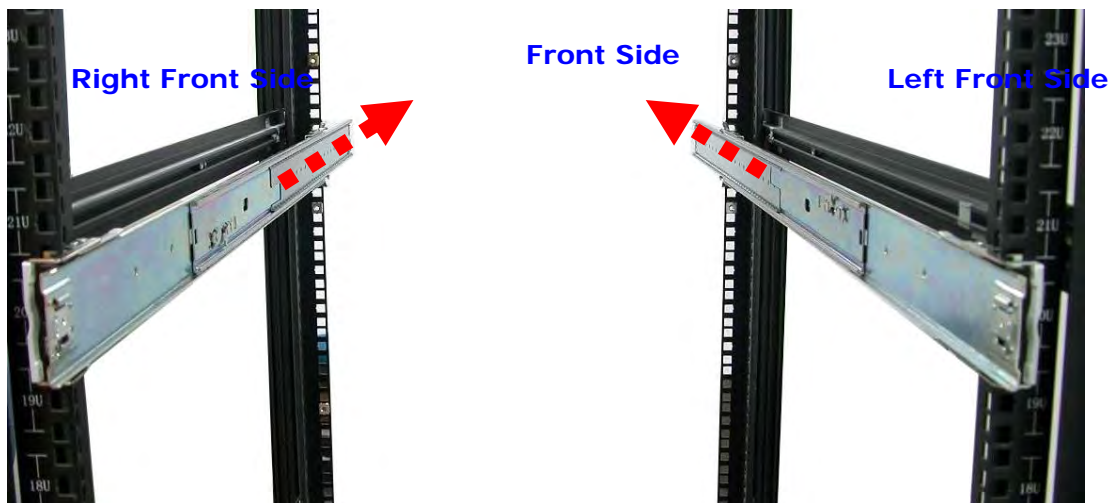

View from Rear Side

13. With at least 2 persons carrying the enclosure, insert the 2 inner rails (attached to the sides of the enclosure) into the middle rails. Slide the enclosure until it stops or about half way through.



NOTE: Be careful when inserting the 2 inner rails into the middle rails. The 2 inner rails must be parallel with the 2 middle rails so that 2 inner rails will insert and slide easily.

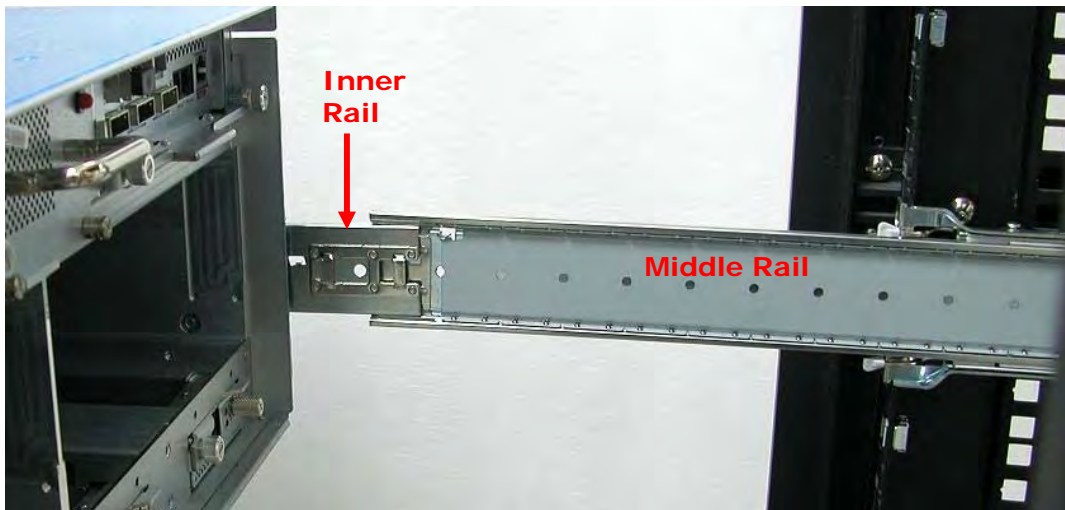

Inner Rail Aligned with Middle Rail

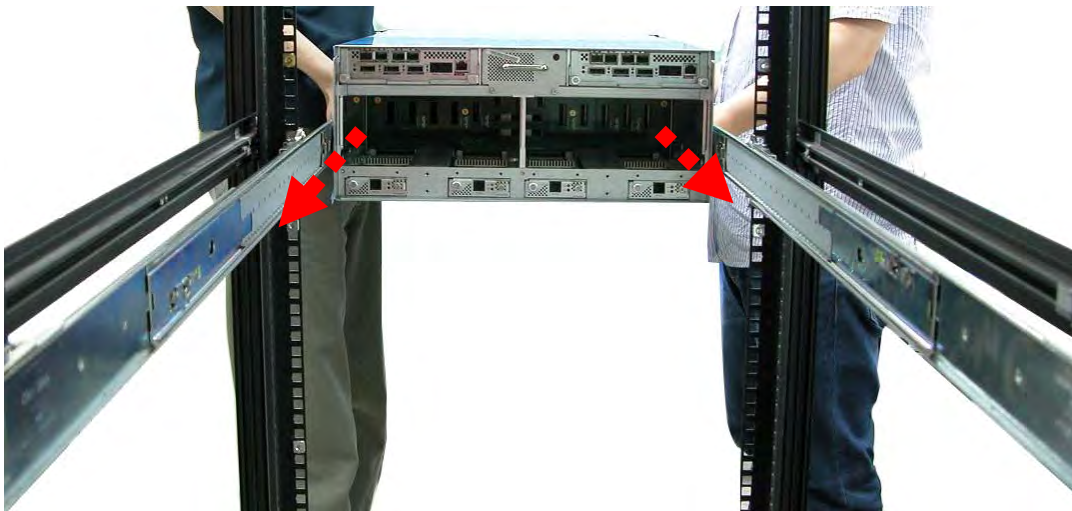

View from Rear Side

14. Press outwards the blue locks on both sides of the inner rail members at the same time. Then push the enclosure inwards until it goes inside the rack.

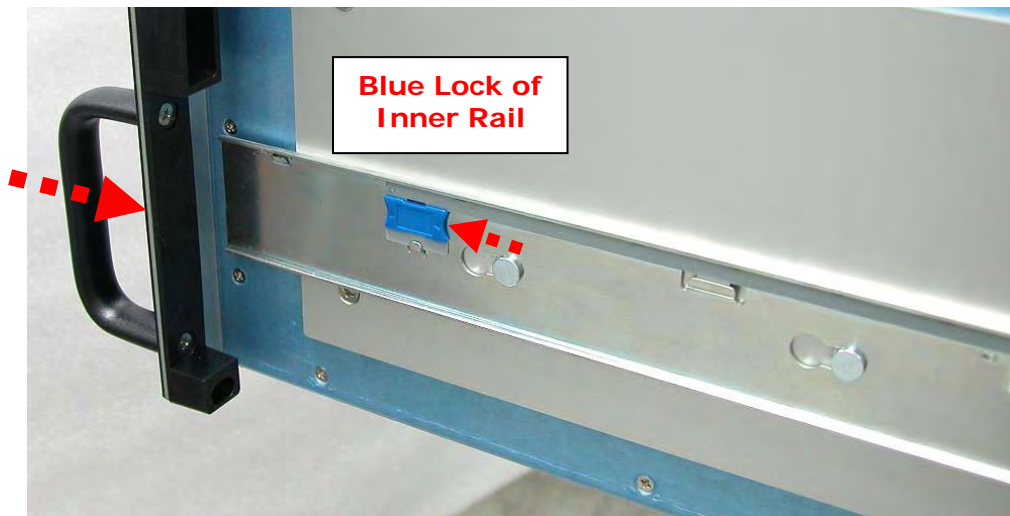

**View from Right Side of Enclosure
Blue Lock of Inner Rail is Pushed a Little Outwards and
Enclosure is Pushed Inwards**



**View from Rear Side of Rack Cabinet
Enclosure is Pushed Inwards**

15. Insert the 2 power supply modules.



16. Open the top cover and re-insert the disk drives / disk trays, if disk drives/disk trays were previously removed. Then close the top cover.

17. Use four (4) M5 screws to lock the enclosure into the rack post.



Front Left Side



Front Right Side

3.2 Preparing the RAID Subsystem

1. Install the disk drives, if not yet installed. Refer to Section 2.6.2 Disk Drive Installation for detailed information.
2. Attach network cable to the R-Link port. Connect the other end to your network hub or switch.
3. Connect one end of SAS cable to the Host Channel port of the subsystem and the other end to the SAS HBA on the Host system or to the SAS switch.



NOTE: If a JBOD subsystem will be connected to the RAID Subsystem, connect the SAS cable from the SAS Expansion Port of RAID Subsystem to the SAS In Port of JBOD subsystem.

3.3 Powering On

1. Plug in all the power cords into the AC Power Input Socket located at the PSFM.



NOTE: The subsystem is equipped with redundant, full range power supplies with PFC (power factor correction). The system will automatically select voltage.



NOTE: The PSFM has a 5V standby DC voltage. When the power cord(s) is/are connected to the AC Power Input Socket, after 1 second, all 42 Activity LEDs will flash once. When the power cord(s) is/are disconnected from AC Power Input Socket, after 3 seconds, all 42 Activity LEDs will flash twice.

2. Turn on each Power On/Off Switch of the PSFM.



NOTE: When the power cord connected from main power source is inserted to the AC Power Input Socket, the Power Status LED becomes **RED**. When the switch of the PSFM is turned on, the LED still shows **RED**. After the main switch in front panel is turned on, the LED turns **GREEN**, which means it is functioning normally.

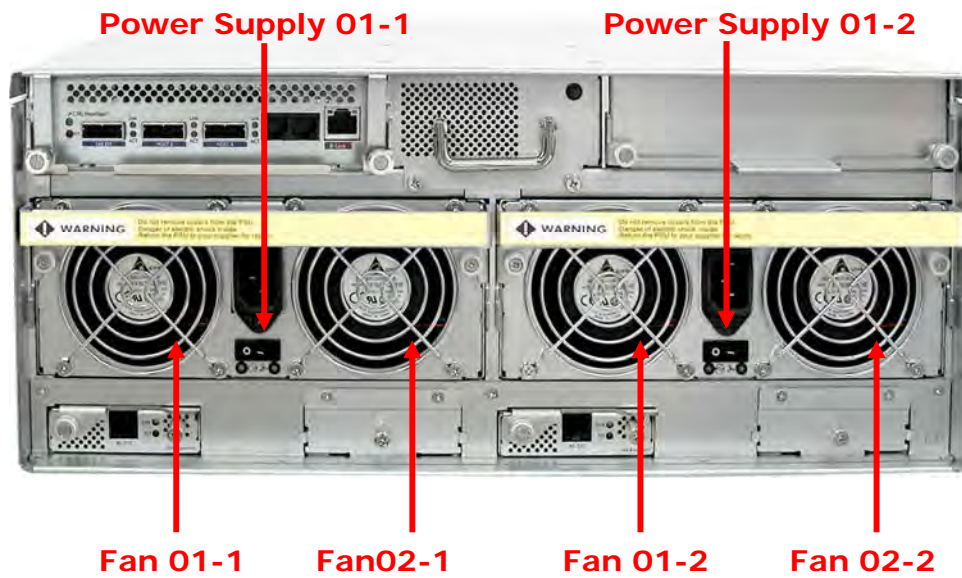

3. To power on the subsystem, turn on the main switch (open first the switch cover) in the right corner side of front panel.



4. Allow the machine a few moments to initialize before using it.



NOTE: The system will initialize after turning on the Main Switch. Each disk slot will be checked during subsystem initialization.

5. Configure RAID using the utility options described in the next chapter.

3.4 Powering Off



IMPORTANT: When powering off the RAID Subsystem, turn off first the Main Switch and allow at least 3 minutes for the subsystem to shutdown properly. During this time, each disk slot starting from slot #1 until slot #42 will be powered down.

When subsystem has totally powered down, turn off the switches of the 2 Power Supply Fan Modules at the rear.



Sequence of disk slot power down (from slot 1 to slot 42)

Chapter 4 RAID Configuration Utility Options

Configuration Methods

There are three methods of configuring the RAID controller:

- a. Front panel touch-control buttons
- b. Web browser-based remote RAID management via the R-Link Ethernet port
- c. Telnet connection via the R-Link Ethernet port



NOTE: The RAID subsystem allows you to access using only one method at a time. You cannot use more than one method at the same time.

4.1 Configuration through Telnet



NOTE: This example uses CRT terminal emulation program. You can also use Windows Hyper terminal as another option.

1. To connect to RAID subsystem using Telnet, open Terminal Emulation program (example, CRT 6.1) and start new session, and select Telnet protocol. Click "Next".

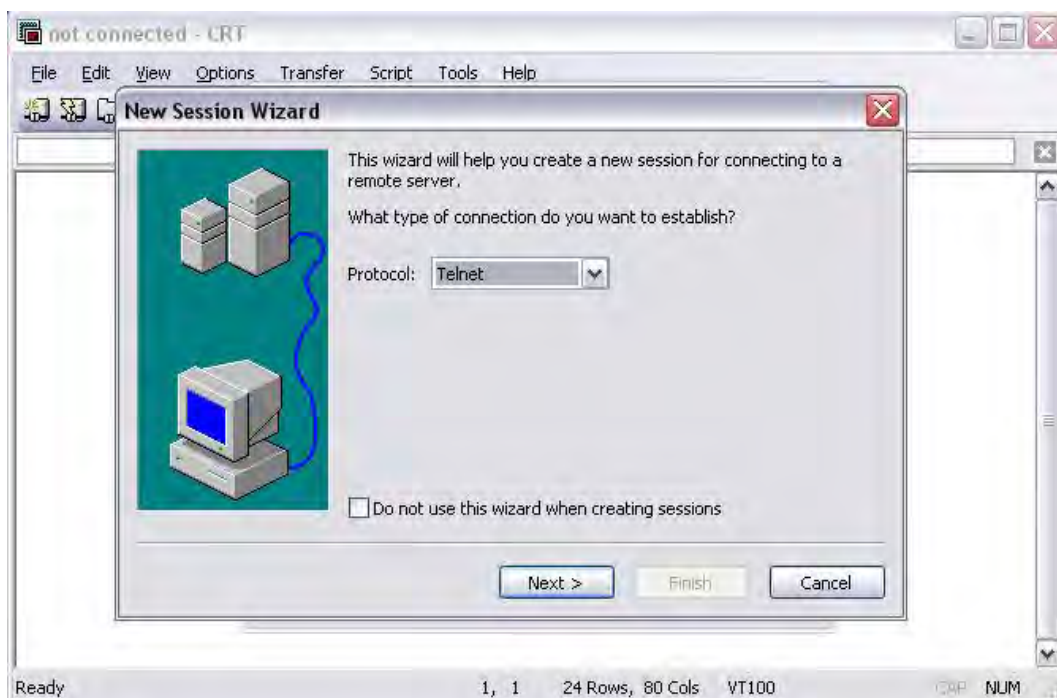

2. Enter the RAID subsystem's IP address. Make sure the PC running the terminal emulation program can connect to the RAID subsystem's IP address. Click "Next".

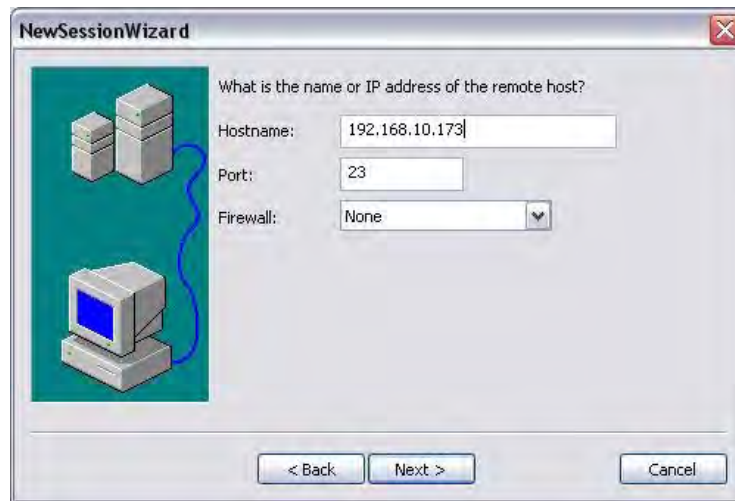

3. Rename the Session name if necessary. Click "Finish".



4. Select the Session name and click "Connect".

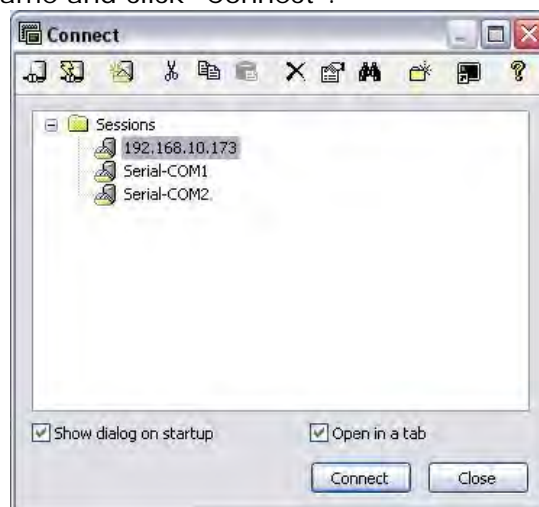

5. After successful connection, the Main Menu will be displayed. Select a menu and the Password box will be shown. Enter password (default is 00000000) to login.

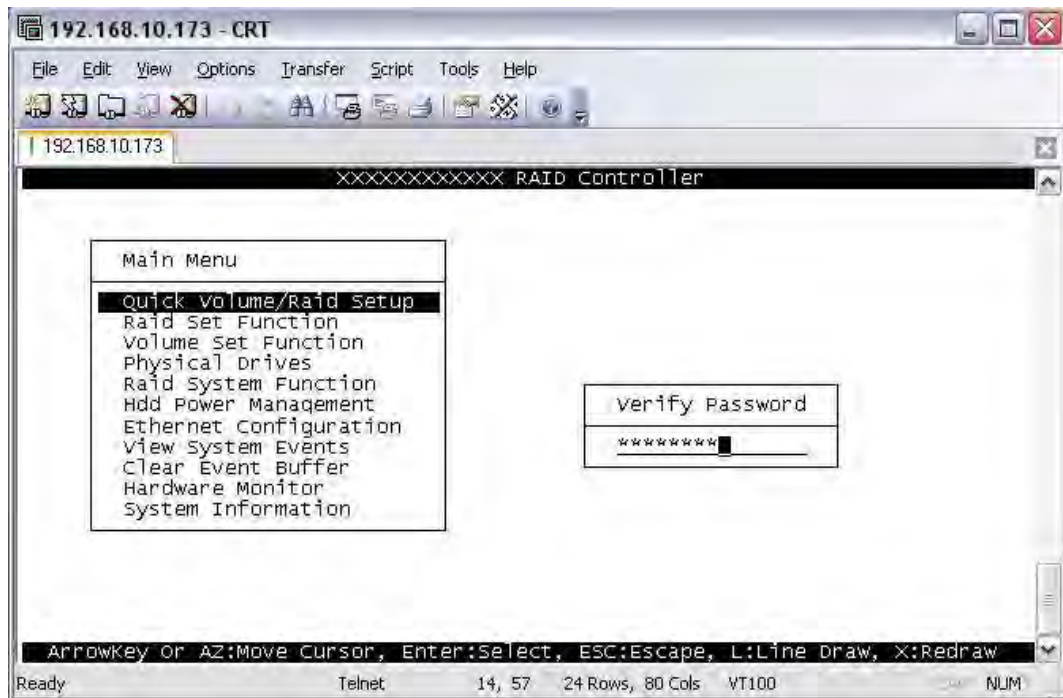

Keyboard Function Key Definitions

- "A" key - to move to the line above
- "Z" key - to move to the next line
- "Enter" key - Submit selection function
- "ESC" key - Return to previous screen
- "L" key - Line draw
- "X" key - Redraw

Main Menu

The main menu shows all function that enables the customer to execute actions by clicking on the appropriate link.

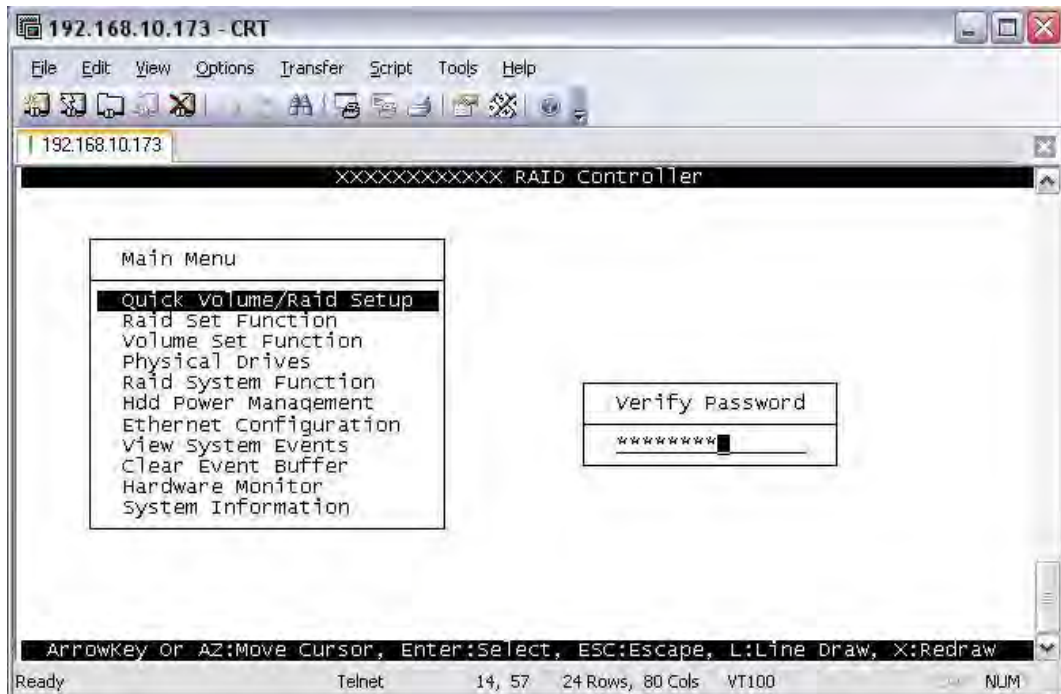

NOTE: The password option allows user to set or clear the RAID subsystem's password protection feature. Once the password has been set, the user can only monitor and configure the RAID subsystem by providing the correct password. The password is used to protect the RAID subsystem from unauthorized access. The controller will check the password only when entering the Main menu from the initial screen. The RAID subsystem will automatically go back to the initial screen when it does not receive any command in twenty seconds. The RAID subsystem's factory default password is set to 0000000.

VT100 terminal configuration Utility Main Menu Options

Select an option and the related information or submenu items display beneath it. The submenus for each item are shown in Section 4.2.1. The configuration utility main menu options are:

Option	Description
Quick Volume And RAID Set Setup	Create a RAID configuration which consists of all physical disks installed
RAID Set Functions	Create a customized RAID Set
Volume Set Functions	Create a customized Volume Set
Physical Drive Functions	View individual disk information
RAID System Functions	Setting the RAID system configurations
Ethernet Configuration	Setting the Ethernet configurations
Views System Events	Record all system events in the buffer
Clear Event Buffer	Clear all event buffer information
Hardware Monitor	Show all system environment status
System Information	View the controller information



4.2 Configuration through the LCD Panel

All configurations can be performed through the LCD Display front panel function keys, except for the "Firmware update". The LCD provides a system of screens with areas for information, status indication, or menus. The LCD screen displays menu items or other information up to two lines at a time. The RAID controller's factory default password is set to **00000000**.

Function Key Definitions

If you are going to configure the subsystem using the LCD panel, please press first the select button.



Parts	Function
Up and Down Arrow buttons 	Use the Up or Down arrow keys to go through the information on the LCD screen. This is also used to move between each menu when you configure the RAID.
Select button 	This is used to enter the option you have selected.
Exit button EXIT	Press this button to return to the previous menu. NOTE: This button can also be used to reset the alarm beeper. For example, if one disk drive fails, pressing this button will mute the beeper.

4.2.1 Menu Diagram

The following menu diagram is a summary of the various configurations and setting functions that can be accessed through telnet. The LCD panel menus also have similar functions except Update Firmware.

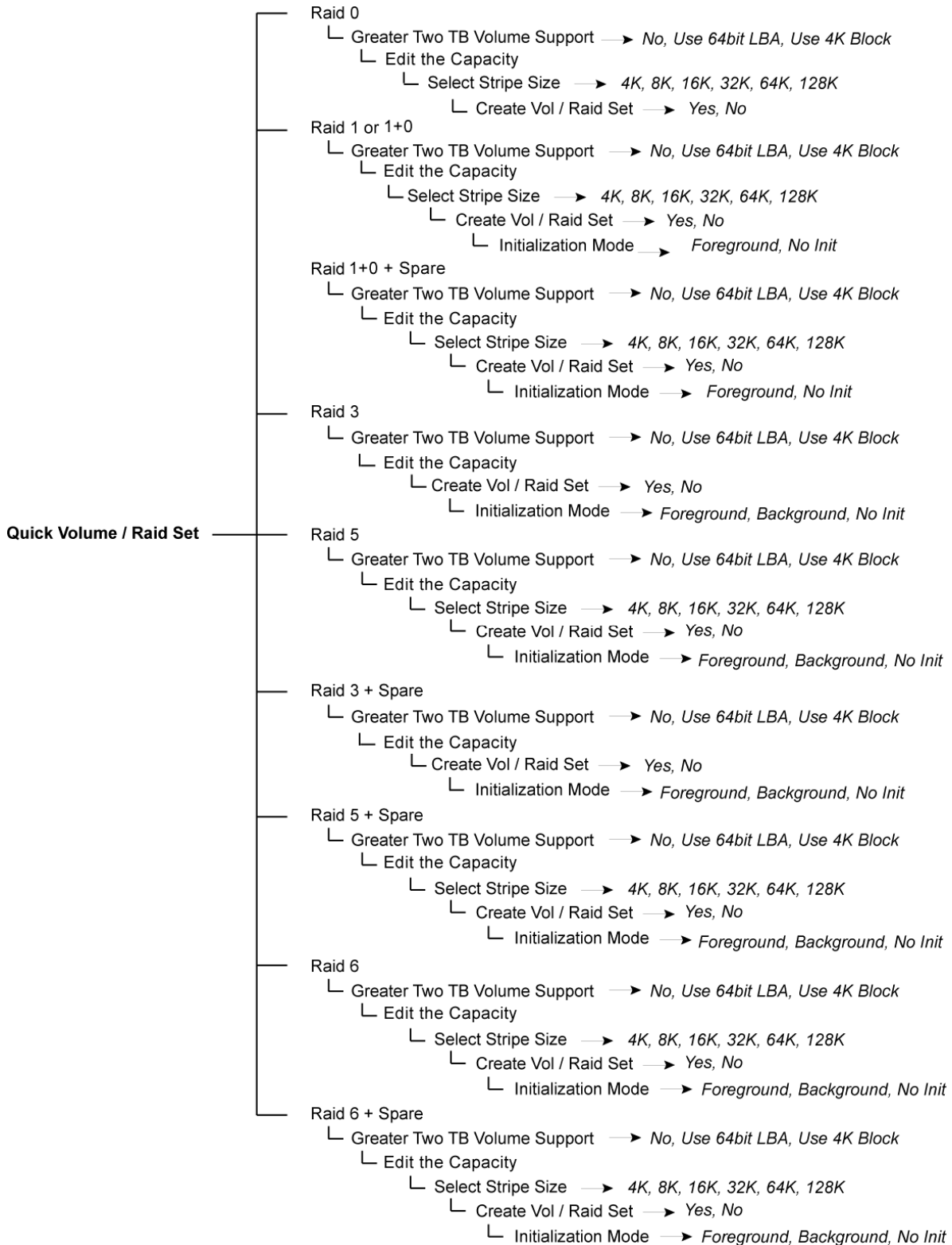

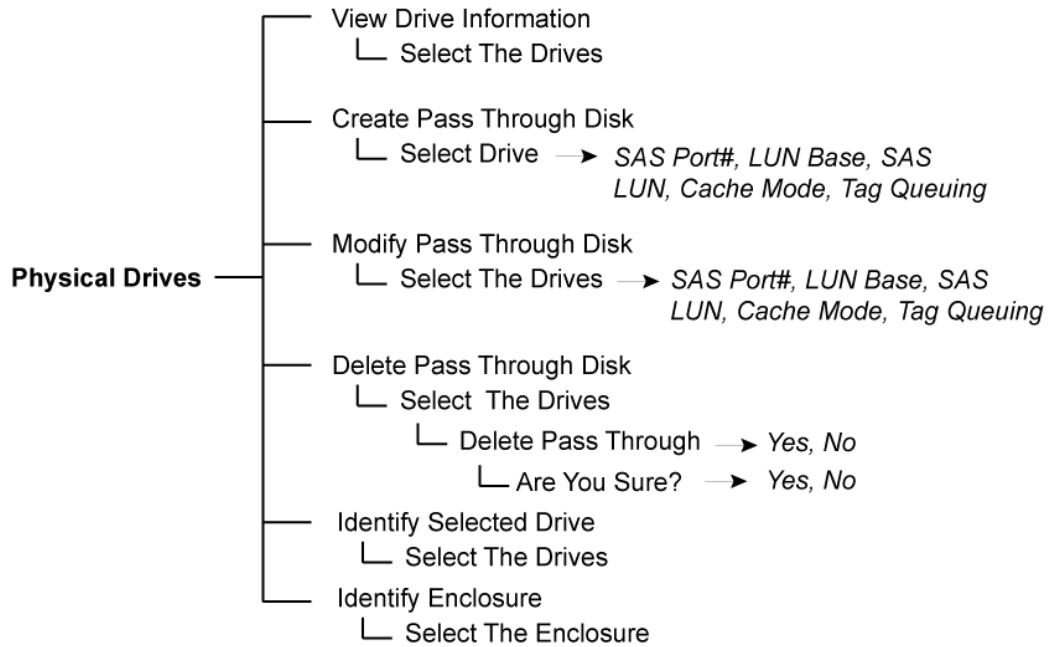

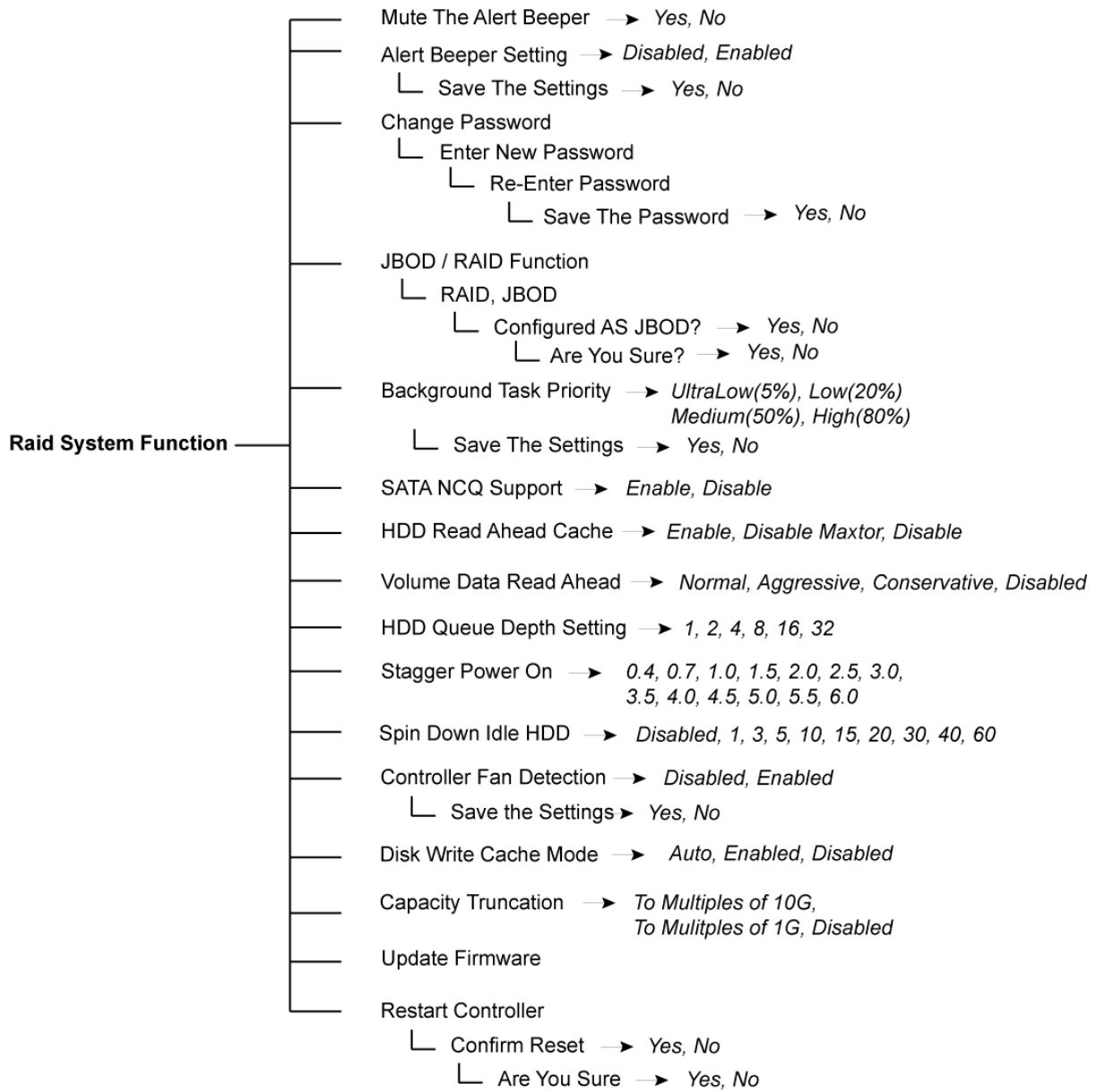

Hdd Power Management	Stagger Power On →	0.4, 0.7, 1.0, 1.5, 2.0, 2.5, 3.0, 3.5, 4.0, 4.5, 5.0, 5.5, 6.0
	└ Save the Settings →	Yes, No
	Time to Low Power Idle →	Disabled, 2, 3, 4, 5, 6, 7
	└ Save the Settings →	Yes, No
	Time to Low RPM Mode →	Disabled, 10, 20, 30, 40, 50, 60
	└ Save the Settings →	Yes, No
	Time to Spin Down Hdd →	Disabled, 1, 3, 5, 10, 15, 20, 30, 40, 60
	└ Save the Settings →	Yes, No

Ethernet Configuration	DHCP Function →	Disabled, Enabled
	Local IP Address:	
	HTTP Port Number:	80
	Telnet Port Number:	23
	SMTP Port Number:	25
	Ethernet Address:	

View System Events	————	Show System Events
Clear Event Buffers	————	Clear Event Buffer → Yes, No
Hardware Monitor	————	The Hardware Monitor Information
System Information	————	The System Information

4.3 Configuration via web browser-based proRAID Manager

The RAID Subsystem can be remotely configured via R-Link port with proRAID Manager, a web browser-based application. The proRAID Manager can be used to manage all available functions of the RAID controller.

To configure the RAID Subsystem from a remote machine, you need to know its IP Address. Launch your web browser from remote machine and enter in the address bar:

http://[IP-Address].



IMPORTANT! The default IP address of R-Link Port is 192.168.1.100, and subnet mask is 255.255.255.0. DHCP client function is also enabled by default. You can reconfigure the IP Address or disable the DHCP client function through the LCD front panel or terminal "Ethernet Configuration" menu.



NOTE: If DHCP client function is enabled but a DHCP server is unavailable and the IP address is changed, a Controller Restart is necessary. If the DHCP client function is disabled and the IP address is changed, Controller Restart is not needed.

Note that you may need to be logged in as administrator with local admin rights on the remote machine to remotely configure the RAID Subsystem. The RAID Subsystem's controller default User Name is "**admin**" and the Password is "**00000000**".

Controller H/W Monitor	
CPU Temperature	51 °C
Controller Temp.	41 °C
12V	12.038 V
5V	4.972 V
3.3V	3.296 V
DDR-II +1.8V	1.824 V
CPU +1.8V	1.824 V
CPU +1.2V	1.248 V
CPU +1.0V	1.024 V
DDR-II +0.9V	0.896 V
RTC 3.0V	3.248 V
Battery Status	Not installed
Enclosure#1 : SAS2 E -.B0.00.b000(40)	
1V-1	1.020 V
5V-1	5.010 V
12V-1	12.120 V
Fan1-1	5620 RPM
Fan2-1	5530 RPM
Fan3-1	8430 RPM
Fan4-1	7840 RPM
Fan5-1	7500 RPM
Fan6-1	3750 RPM
Power 01-1	OK
ENC. Temp	45 °C
Chip Temp	71 °C
Slot01 Temp	33 °C

Main Menu

The main menu shows all available function that user can execute by clicking on the appropriate hyperlink.

Individual Category	Description
Quick Function	Create a RAID configuration, which consists of all physical disks installed. The Volume Set Capacity, RAID Level, and Stripe Size can be modified during setup.
RAID Set Functions	Create customized RAID Sets.
Volume Set Functions	Create customized Volume Sets and allow modification of parameters of existing Volume Sets parameter.
Physical Drive	Create pass through disks and allow modification of parameters of existing pass through drives. This also provides a function to identify a disk drive.
System Control	For setting the RAID system configurations.
Information	To view the controller and hardware monitor information. The RAID Set hierarchy can also be viewed through the RAID Set Hierarchy item.

Chapter 5 RAID Management

5.1 Quick Function

5.1.1 Quick Create

The number of physical drives in the RAID Subsystem determines the RAID levels that can be implemented with the RAID Set. This feature allows user to create a RAID Set associated with exactly one Volume Set. User can change the RAID Level, Capacity, Volume Initialization Mode and Stripe Size. A hot spare can also be created depending upon the existing configuration.

If the Volume Set size is over 2TB, an option "Greater Two TB Volume Support" will be automatically provided in the screen as shown in the example below. There are three options to select: "No", "64bit LBA", and "4K Block").

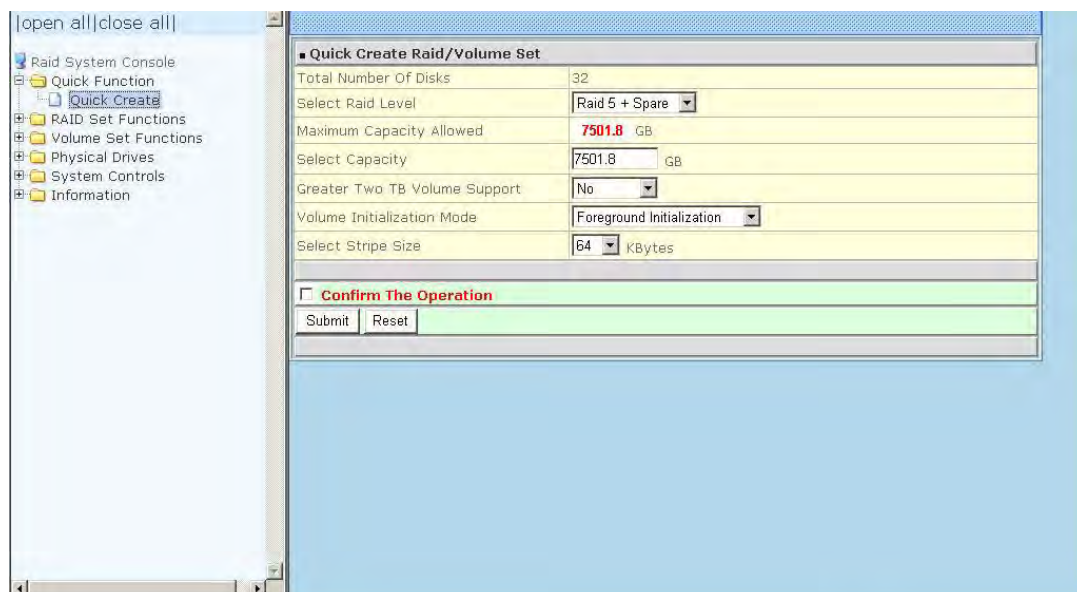

Greater Two TB Volume Support:

No: Volume Set capacity is set to maximum 2TB.

64bit LBA: Use this option for UNIX, Linux Kernel 2.6 or later, Windows Server 2003 + SP1 or later versions, Windows x64, and other supported operating systems. The maximum Volume Set size is up to 512TB.

4K Block: Use this option for Windows OS such as Windows 2000, 2003, or XP. The maximum Volume Set size is 16TB. Just use the Volume as "Basic Disk". Volume can't be used as "Dynamic Disk"; also can't be used in 512Bytes block service program.

Tick on the **Confirm The Operation** option and click on the **Submit** button in the Quick Create screen. The RAID Set and Volume Set will start to initialize.

You can use **RAIDSet Hierarchy** feature to view the Volume Set information (Refer to Section 5.6.1).



NOTE: In Quick Create, your RAID Set is automatically configured based on the number of disks in your system (maximum 32 disks per RAID Set). Use the RAID Set Function and Volume Set Function if you prefer to create customized RAID Set and Volume Set.



NOTE: In Quick Create, the RAID Level options 30, 50, and 60 are not available. If you need to create Volume Set with RAID Level 30, 50, or 60, use the Create RAID Set function and Create Volume Set function.

5.2 RAID Set Functions

Use the RAID Set Function and Volume Set Function if you prefer to create customized RAID Sets and Volume Sets. User can manually configure and take full control of the RAID Set settings, but it will take a little longer to setup than the Quick Create configuration. Select the RAID Set Function to manually configure the RAID Set for the first time or to delete existing RAID Set and reconfigure a RAID Set.

5.2.1 Create RAID Set

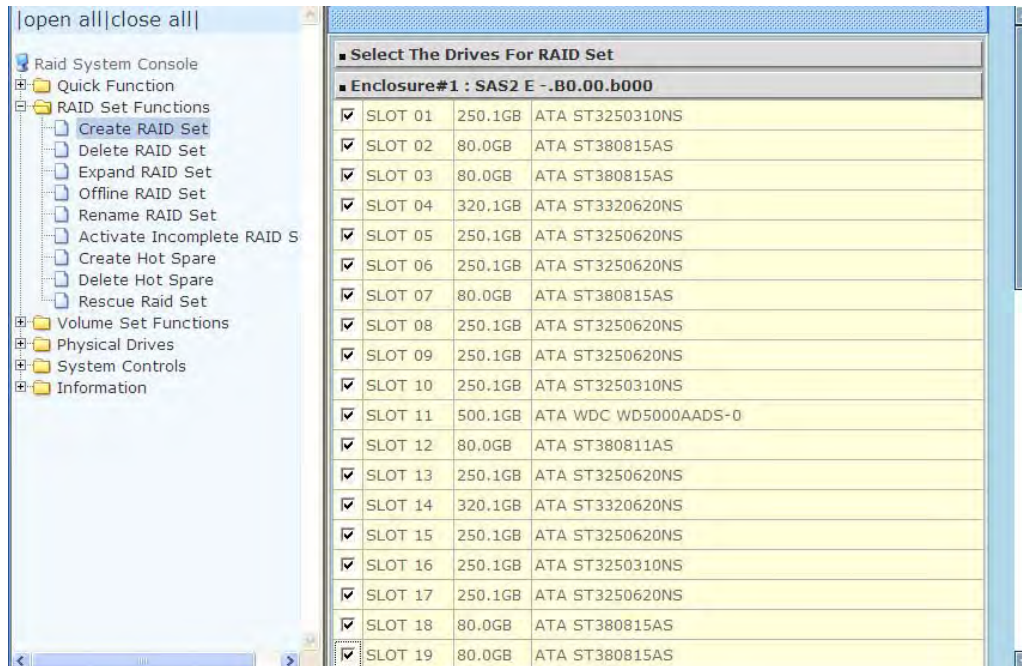

To create a RAID Set, click on the **Create RAID Set** link. A "Select The Drives For RAID Set" screen is displayed showing the disk drives in the system. Tick the box of each disk drive that will be included in RAID Set to be created. Enter the preferred RAID Set Name (1 to 16 alphanumeric characters) to define a unique identifier for the RAID Set. Default RAID Set name always appear as **RAID Set # xxx**.

Tick on the **Confirm The Operation** option and click on the **Submit** button in the screen.



NOTE: Maximum number of disk drives supported per RAID Set is 32. For example, if you have 42 disk drives in the subsystem, only 32 disks will be used when a single RAID Set is created. To use all 42 disks, you can create two RAID Sets, each with 21 disks, to create a RAID 30, 50, or 60 Volume Set.

5.2.2 Delete RAID Set

To delete a RAID Set, click on the **Delete RAID Set** link. A “Select The RAID Set To Delete” screen is displayed showing all RAID Sets existing in the system. Select the RAID Set you want to delete in the Select column.

Tick on the **Confirm The Operation** and click on the **Submit** button to process with deletion.

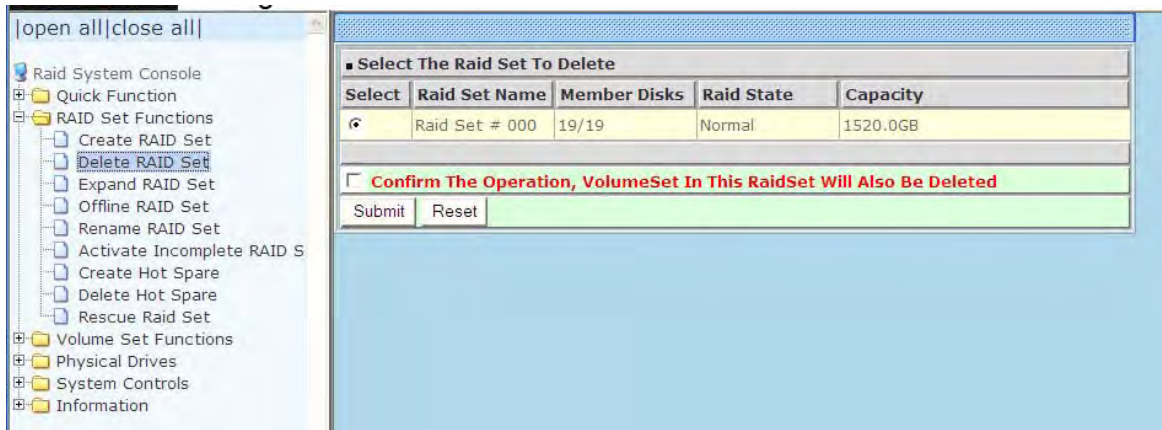

NOTE: You cannot delete a RAID Set containing a RAID 30/50/60 Volume Set. You must delete the RAID 30/50/60 Volume Set first.

5.2.3 Expand RAID Set

Use this option to expand a RAID Set, when one or more disk drives is/are added to the system. This function is active when at least one drive is available.

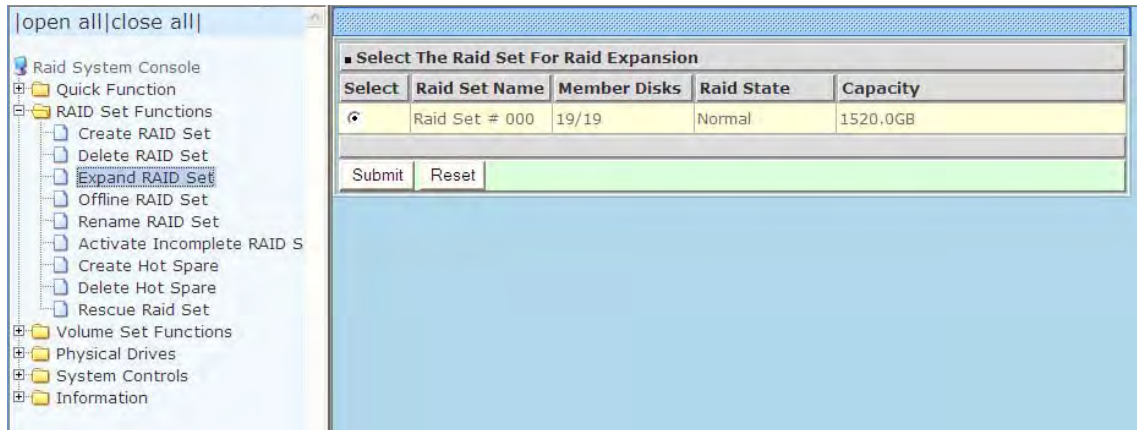

To expand a RAID Set, click on the **Expand RAID Set** link. Select the RAID Set which you want to expand.

Tick on the available disk(s) and check **Confirm The Operation**. Click on the **Submit** button to add the selected disk(s) to the RAID Set.



NOTE: Once the Expand RAID Set process has started, user cannot stop it. The process must be completed.



NOTE: If a disk drive fails during RAID Set expansion and a hot spare is available, an auto rebuild operation will occur after the RAID Set expansion is completed.



NOTE: A RAID Set cannot be expanded if it contains a RAID 30/50/60 Volume Set.

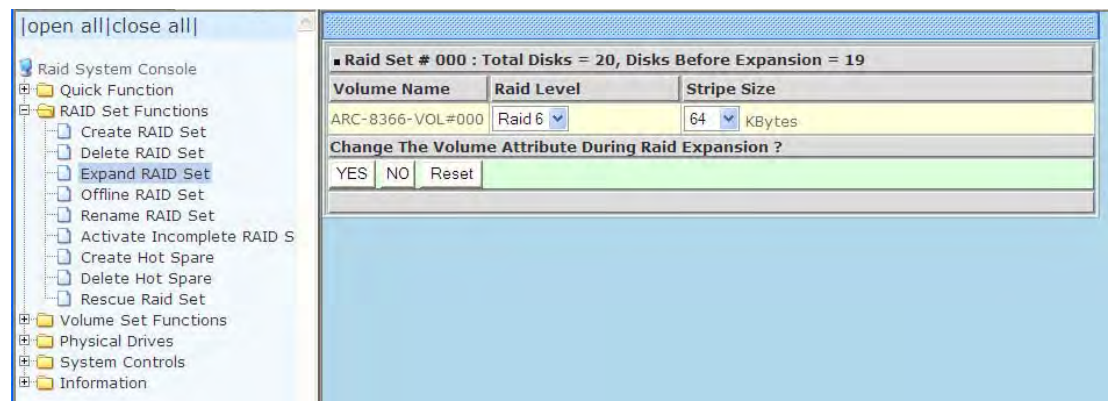
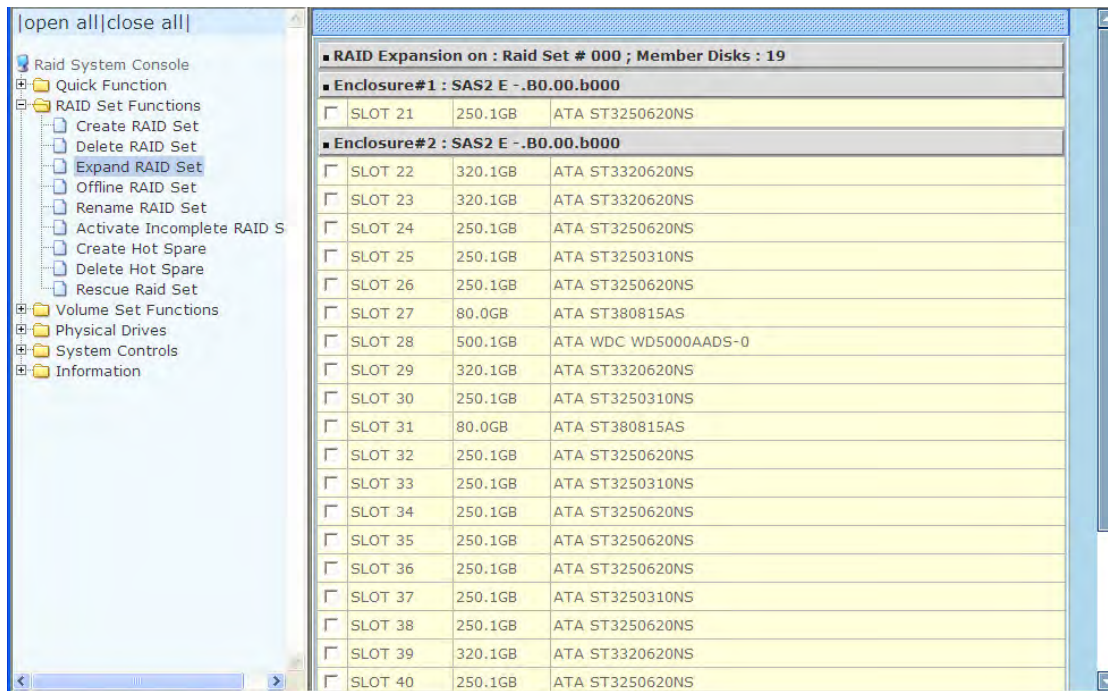

Migration occurs when a disk is added to a RAID Set. Migrating status is displayed in the RAID Set status area of the RAID Set information. Migrating status is also displayed in the Volume Set status area of the Volume Set Information for all Volume Sets under the RAID Set which is migrating.

The screenshot displays the RAID System Console interface. On the left is a tree view with the following items: Raid System Console, Quick Function, RAID Set Functions, Volume Set Functions, Physical Drives, System Controls, Information, RAID Set Hierarchy (selected), SAS Chip Information, System Information, and Hardware Monitor. The main window shows a 'Stop Auto Refresh' button and a 'RaidSet Hierarchy' table. The table has five columns: RAID Set, Devices, Volume Set(Port/Lun), Volume State, and Capacity. The first row shows RAID Set # 000 with devices E#1SLOT 01 through E#1SLOT 21. The Volume Set is 'Volume--VOL#000(0/0)' and the Volume State is 'Migrating(0.0%)'. The Capacity is 1000.0GB. At the bottom, the enclosure information is shown as 'Enclosure#1 : SAS2 E -.B0.00.b000(40)[5001B4D50915F03F]'.

RAID Set	Devices	Volume Set(Port/Lun)	Volume State	Capacity
Raid Set # 000	E#1SLOT 01	Volume--VOL#000(0/0)	Migrating(0.0%)	1000.0GB
	E#1SLOT 02			
	E#1SLOT 03			
	E#1SLOT 04			
	E#1SLOT 05			
	E#1SLOT 06			
	E#1SLOT 07			
	E#1SLOT 08			
	E#1SLOT 09			
	E#1SLOT 10			
	E#1SLOT 11			
	E#1SLOT 12			
	E#1SLOT 13			
	E#1SLOT 14			
	E#1SLOT 15			
	E#1SLOT 16			
	E#1SLOT 17			
	E#1SLOT 18			
	E#1SLOT 19			
	E#1SLOT 21			

Enclosure#1 : SAS2 E -.B0.00.b000(40)[5001B4D50915F03F]

5.2.4 Offline RAID Set

If user wants to offline (and move) a RAID Set while the system is powered on, use the Offline RAID Set function. After completing the function, the HDD state will change to “Offlined” Mode and the HDD Status LEDs will be blinking RED.

To offline a RAID Set, click on the **Offline RAID Set** link. A “Select The RAID SET To Offline” screen is displayed showing all existing RAID Sets in the subsystem. Select the RAID Set which you want to offline in the Select column.

Tick on the **Confirm The Operation**, and then click on the **Submit** button to offline the selected RAID Set.

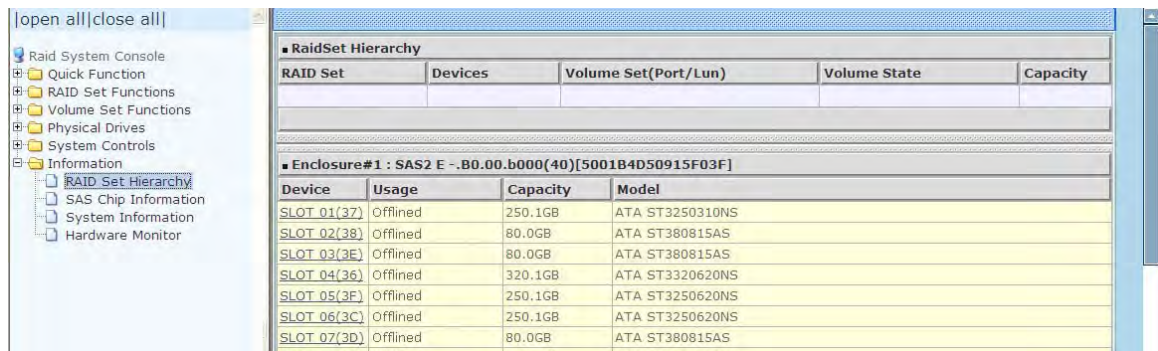
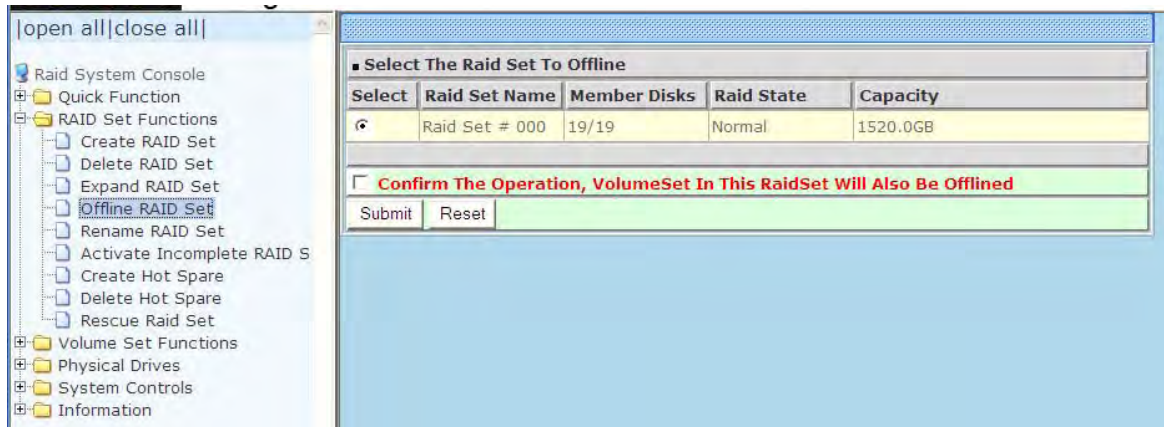

5.2.5 Rename RAID Set

Use this function to rename a RAID Set. Select the **"Rename RAID Set"** under the RAID Set Functions, and then select the RAID Set to rename and click **"Submit"**.

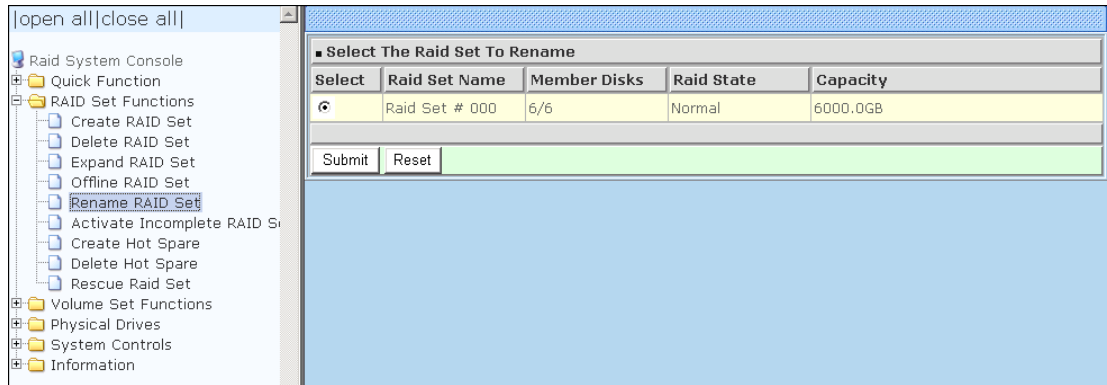

Enter the new name for the RAID Set. Tick the **"Confirm The Operation"** and click **"Submit"**.

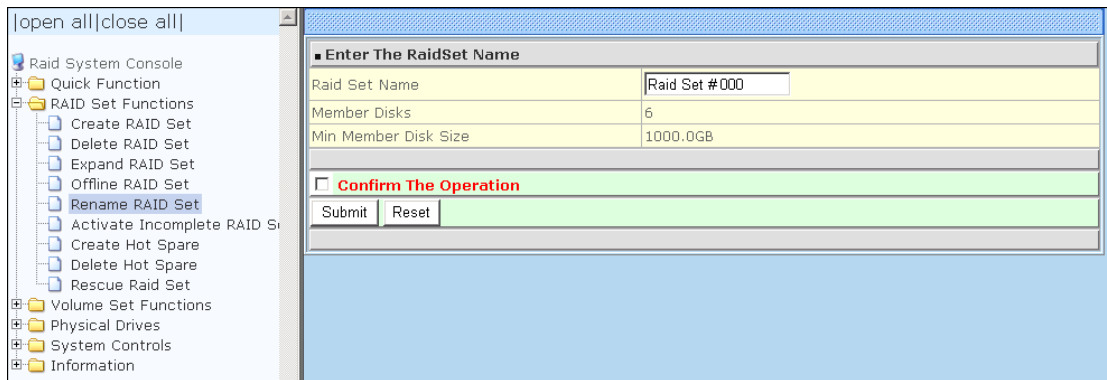

5.2.6 Activate Incomplete RAID Set

When RAID Set State is **“Normal”**, this means there is no failed disk drive.

■ Raid Set Information	
Raid Set Name	Raid Set # 000
Member Disks	3
Total Raw Capacity	247.0GB
Free Raw Capacity	0.0GB
Min Member Disk Size	82.3GB
Raid Set Power State	Operating
Raid Set State	Normal

When does a RAID Set State becomes “Incomplete”?

If the RAID Subsystem is powered off and one disk drive is removed or has failed in power off state, and when the subsystem is powered on, the RAID Set State will change to **“Incomplete”**.

■ Raid Set Information	
Raid Set Name	Raid Set # 000
Member Disks	3
Total Raw Capacity	247.0GB
Free Raw Capacity	247.0GB
Min Member Disk Size	82.3GB
Raid Set Power State	Operating
Raid Set State	Incomplete

The Volume Set(s) associated with the RAID Set will not be visible and the failed or removed disk will be shown as **“Missing”**. At the same time, the subsystem will not detect the Volume Set(s); hence the volume(s) is/are not accessible.

■ RAID Set Hierarchy			
RAID Set	Devices	Volume Set(Port/Lun)	Volume State
Raid Set # 000	E#1Slot#1		
	E#1Slot#2		
	Missing		

■ Enclosure#1 : SAS RAID Subsystem V1.0			
Device	Usage	Capacity	Model
Slot#1(0:1)	Raid Set # 000	500.1GB	HDS725050KLA360
Slot#2(0:2)	Raid Set # 000	500.1GB	HDS725050KLA360

When can the “Activate Incomplete RAID Set” function be used?

In order to access the Volume Set(s) and corresponding data, use the **Activate Incomplete RAID Set** function to activate the RAID Set. After selecting this function, the RAID State will change to “**Degraded**” state.

To activate the incomplete the RAID Set, click on the **Activate Incomplete RAID Set** link. A “Select The RAID Set To Activate” screen is displayed showing all existing RAID Sets in the subsystem. Select the RAID Set with “**Incomplete**” state which you want to activate in the Select column.

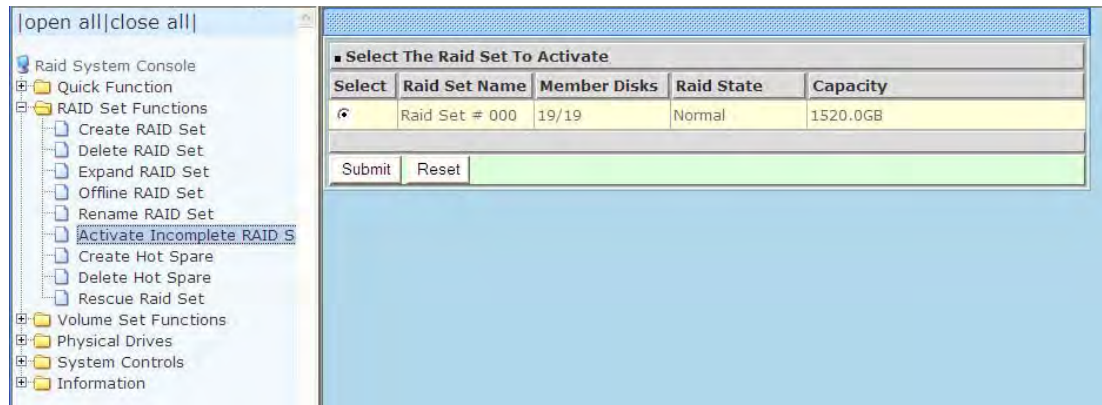

Click on the **Submit** button to activate the RAID Set. The Volume Set(s) associated with the RAID Set will become accessible in “**Degraded**” mode.



NOTE: The “Activate Incomplete RAID Set” function is only used when RAID Set State is “Incomplete”. It cannot be used when RAID Set configuration is lost. If in case the RAID Set configuration is lost, please contact your vendor’s support engineer.

5.2.7 Create Hot Spare

The Create Hot Spare option gives you the ability to define a global hot spare.

When you choose the **Create Hot Spare** option in the RAID Set Function, all unused (non RAID Set member) disk drives in the subsystem appear. Select the target disk drive by clicking on the appropriate check box. Tick on the **Confirm The Operation** and click on the **Submit** button to create hot spare drive(s).

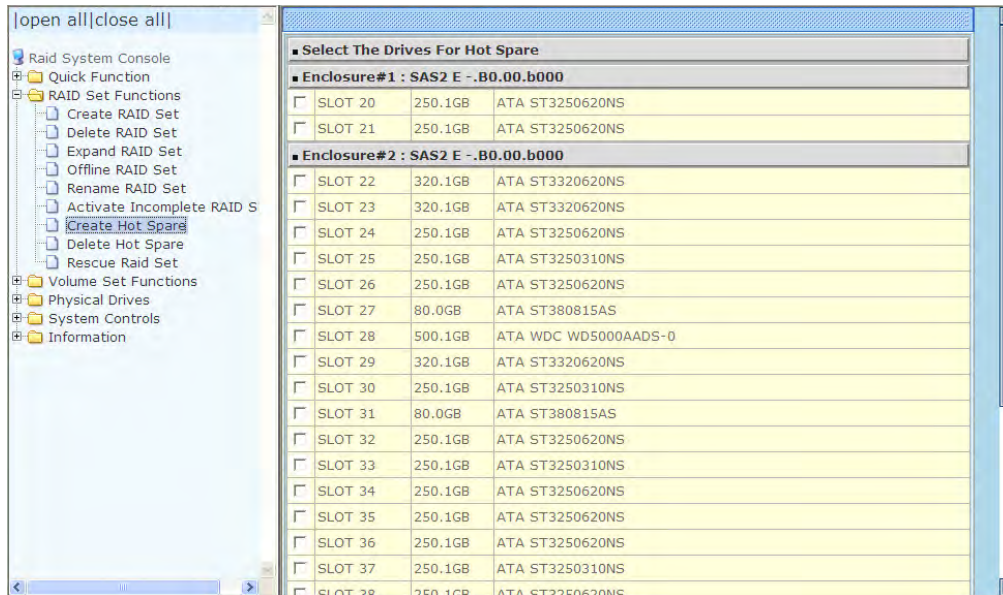

Hot Spare Type	Description
Global Hot Spare	The Hot Spare disk is a hot spare on all enclosures connected in daisy chain. It can replace any failed disk in any enclosure.
Dedicated to RAIDSet	The Hot Spare disk is a hot spare dedicated only to the RAIDSet where it is assigned. It can replace any failed disk in the RAIDSet where it is assigned.
Dedicated to Enclosure	The Hot Spare disk is a hot spare dedicated only to the enclosure where it is located. It can replace any failed disk on the enclosure where it is located. NOTE: When the RAID Set status is in Degraded state, this option will not work.



NOTE: The Hot Spare Type can also be viewed by clicking on RAID Set Hierarchy in the Information menu.

NOTE: The capacity of the hot spare disk(s) must be equal to or greater than the smallest hard disk size in the subsystem so that it/they can replace any failed disk drive.

5.2.8 Delete Hot Spare

Select the target Hot Spare disk(s) to delete by clicking on the appropriate check box.

Tick on the **Confirm The Operation**, and click on the **Submit** button in the screen to delete the hot spare(s).

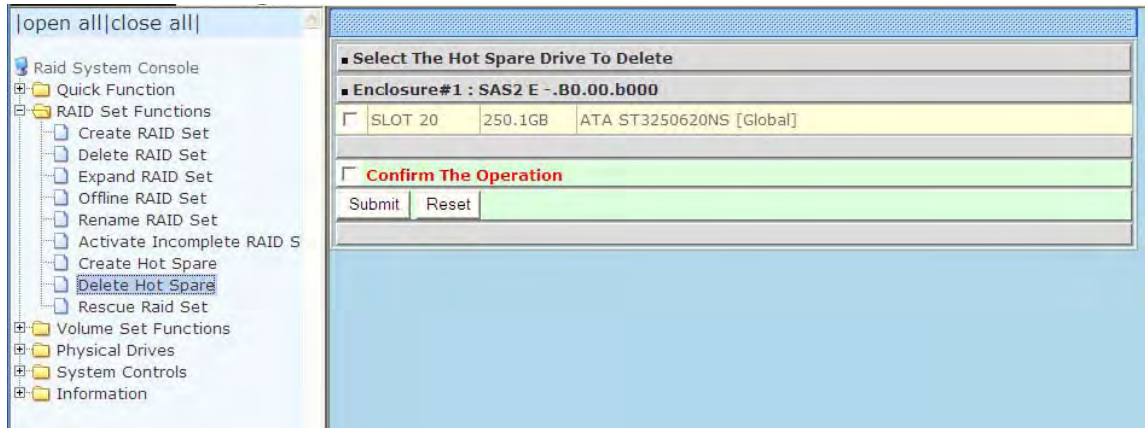

5.2.9 Rescue RAID Set

If you need to recover a missing RAID Set using the “Rescue RAID Set” function, please contact your vendor’s support engineer for assistance.

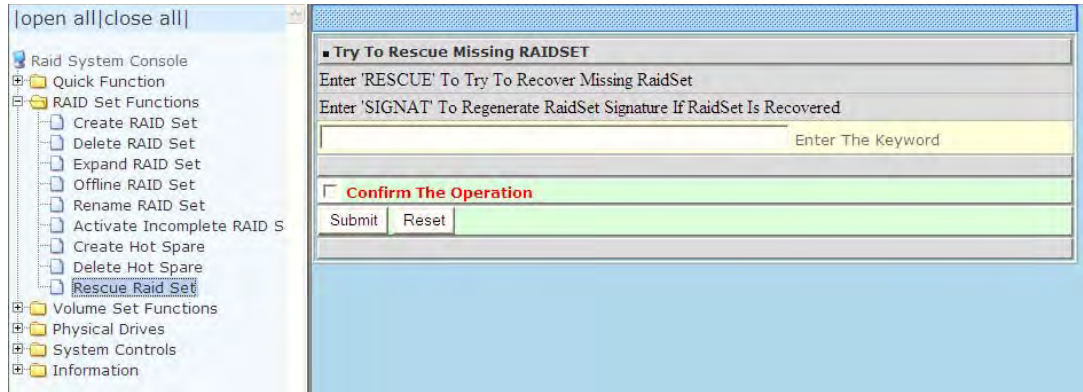

5.3 Volume Set Function

Volume Set is seen by the host system as a single logical device. It is organized in a RAID level with one or more physical disks. RAID level refers to the level of data performance and protection of a Volume Set. A Volume Set capacity can consume all or a portion of the raw capacity available in a RAID Set.

Multiple Volume Sets can exist on a group of disks in a RAID Set. Additional Volume Sets created in a specified RAID Set will reside on all the physical disks in the RAID Set. Thus each Volume Set on the RAID Set will have its data spread evenly across all the disks in the RAID Set.

5.3.1 Create Volume Set

The following are the Volume Set features:

1. Volume sets of different RAID levels may coexist on the same RAID Set.
2. Up to 128 Volume Sets in a RAID Set can be created in the RAID Subsystem.

To create Volume Set from a RAID Set, expand the Volume Set Functions in the main menu and click on the **Create Volume Set** link. The **Select The RAID Set To Create On It** screen will show all existing RAID Sets. Tick on the RAID Set where you want to create the Volume Set and then click on the **Submit** button.



The Volume Set setup screen allows user to configure the Volume Name, Capacity, RAID level, Initialization Mode, Stripe Size, Cache Mode, Tagged Command Queuing, SAS Port/LUN Base/LUN, and Volume To Be Created.

Enter The Volume Attribute	
Volume Name	Volume---VOL#000
Member Disks	19
Volume Raid Level	Raid 6
Max Capacity Allowed	1360 GB
Select Volume Capacity	1000 GB
Volume Initialization Mode	Foreground Initialization
Volume Stripe Size	64 KBytes
Volume Cache Mode	Write Back
Tagged Command Queuing	Enabled
SAS Port:LUN Base:LUN	0 : 0 : 0
Volumes To Be Created	1
<input type="checkbox"/> Confirm The Operation	
Submit Reset	

Volume Name:

The default Volume Set name will appear as "Volume---VOL#XXX". You can rename the Volume Set name provided it does not exceed the 16 characters limit.

Volume RAID Level:

Set the RAID level for the Volume Set. Click the down-arrow in the drop-down list. The available RAID levels for the current Volume Set are displayed. Select the preferred RAID level.

Select Volume Capacity:

The maximum Volume Set size is displayed by default. If necessary, change the Volume Set size appropriate for your application.

Greater Two TB Volume Support:

If the Volume Set size is over 2TB, an option "Greater Two TB Volume Support" will be automatically provided in the screen as shown in the example above. There are three options to select: "No", "64bit LBA", and "4K Block").

No: Volume Set size is set to maximum 2TB limitation.

64bit LBA: Use this option for UNIX, Linux Kernel 2.6 or later, Windows Server 2003 + SP1 or later versions, Windows x64, and other supported operating systems. The maximum Volume Set size is up to 512TB.

4K Block: Use this option for Windows OS such as Windows 2000, 2003, or XP. The maximum Volume Set size is 16TB. Just use the Volume as "Basic Disk". Volume can't be used as "Dynamic Disk"; also can't be used in 512Bytes block service program.

Initialization Mode:

Set the Initialization Mode for the Volume Set. Initialization in Foreground mode is completed faster but must be completed before Volume Set becomes accessible. Background mode makes the Volume Set instantly available but the initialization process

takes longer. No Init (To Rescue Volume) is used to create a Volume Set without initialization; normally used to recreate Volume Set configuration to recover data.

Stripe Size:

This parameter sets the size of the stripe written to each disk in a RAID 0, 1, 0+1, 5 or 6 Volume Set. You can set the stripe size to 4 KB, 8 KB, 16 KB, 32 KB, 64 KB, or 128 KB.

A larger stripe size produces better-read performance, especially if your computer does mostly sequential reads. However, if you are sure that your computer does random reads more often, select a small stripe size.



NOTE: Stripe Size in RAID level 3 can't be modified.

Cache Mode:

The RAID Subsystem supports two types of write caching: Write-Through and Write-Back.

Write-Through: data are both written to the cache and the disk(s) before the write I/O is acknowledged as complete.

Write-Back: when data is written to cache, the I/O is acknowledged as complete, and some time later, the cached data is written or flushed to the disk(s). This provides better performance but requires a battery module support for the cache memory, or a UPS for the subsystem.

Tagged Command Queuing:

When this option is enabled, it enhances the overall system performance under multi-tasking operating systems by reordering tasks or requests in the command queue of the RAID system. This function should normally remain enabled.

SAS Port/LUN Base/LUN:

SAS Port: There are two 3Gbps SAS Host Channels in the RAID Subsystem.

Select the SAS port where to map the LUN (Volume Set). Options are: **0**, **1** and **0&1 Cluster**. "0&1 Cluster" will make the LUN visible on both SAS ports.

LUN Base: The base LUN number. Each LUN Base supports 8 LUNs.

LUN: Each Volume Set must be assigned a unique LUN ID number. A SAS Port can connect up to 128 devices (LUN ID: 0 to 127). Select the LUN ID for the Volume Set.

Volumes To Be Created:

Use this option to create several Volume Sets with the same Volume Set attributes. Up to 128 Volume Sets can be created.

5.3.2 Create RAID 30/50/60

To create a RAID30/50/60 Volume Set, move the mouse cursor to the main menu and click on the **Create RAID30/50/60** link. The **Select Multiple RAIDSet For RAID30/50/60** screen will show all RAID Sets. Tick on the RAID Sets that you want to include in the creation and then click on the **Submit** button.



NOTE: When creating RAID 30/50/60 Volume set, you need to create first the RAID Sets. Up to 8 RAID Sets maximum is supported in RAID 30/50/60. All RAID Sets must contain the same number of disk drives.

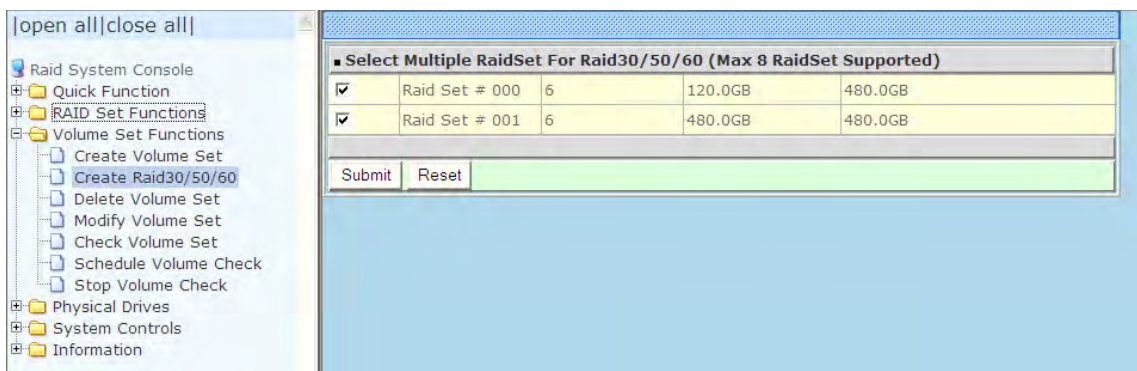

Configure the Volume Set attributes (refer to previous section for the Volume Set attributes). When done, tick **Confirm The Operation** and click on **Submit** button.

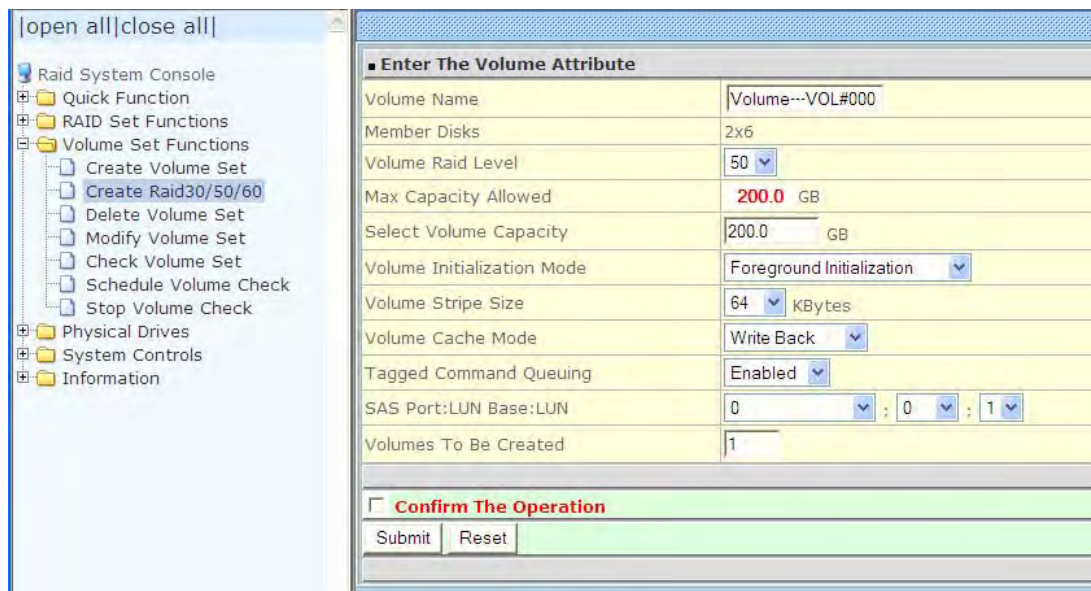

NOTE: Refer to Section 5.3.1 Create Volume Set for detailed information about the Volume Set settings.

5.3.3 Delete Volume Set

To delete a Volume Set, select the Volume Set Functions in the main menu and click on the **Delete Volume Set** link. The **Select The Volume Set To Delete** screen will show all available RAID Sets. Tick on a RAID Set and check the **Confirm The Operation** option and then click on the **Submit** button to show all Volume Sets in the selected RAID Set. Tick on a Volume Set and check the **Confirm The Operation** option. Click on the **Submit** button to delete the Volume Set.

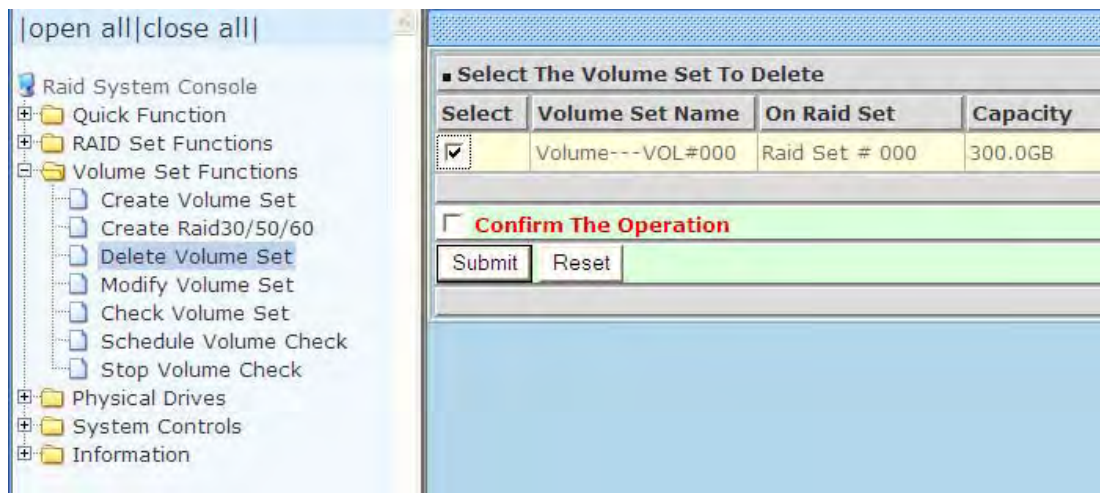

5.3.4 Modify Volume Set

Use this function to modify Volume Set configuration.

To modify the attributes of a Volume Set:

1. Click on the **Modify Volume Set** link.
2. Tick from the list the Volume Set you want to modify. Click on the **Submit** button.



The following screen appears.

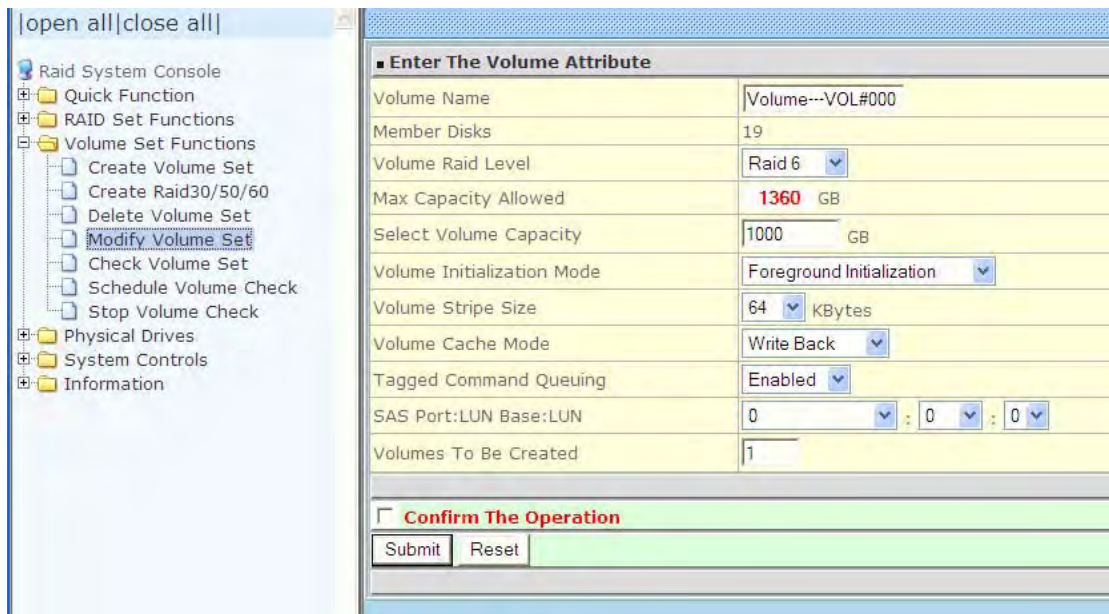

To modify Volume Set attribute values, select an attribute item and click on the attribute value. After completing the modification, tick on the **Confirm The Operation** option and click on the **Submit** button to save the changes.

5.3.4.1 Volume Set Expansion

Volume Capacity (Logical Volume Concatenation Plus Re-stripe)

Use the Expand RAID Set function to expand a RAID Set when a disk is added to your subsystem. (Refer to Section 5.2.3)

The expanded capacity can be used to enlarge the Volume Set size or create another Volume Set. Use the Modify Volume Set function to expand the Volume Set capacity. Select the Volume Set and move the cursor to the **Volume Set Capacity** item and enter the capacity size.

Tick on the **Confirm The Operation** and click on the **Submit** button to complete the action. The Volume Set starts to expand.



NOTE: The Volume Set capacity of RAID30/50/60 cannot be expanded.

Enter The Volume Attribute	
Volume Name	Volume---VOL#000
Member Disks	19
Volume Raid Level	Raid 6
Max Capacity Allowed	1360 GB
Select Volume Capacity	1000 GB
Volume Initialization Mode	Foreground Initialization
Volume Stripe Size	64 kBytes
Volume Cache Mode	Write Back
Tagged Command Queuing	Enabled
SAS Port:LUN Base:LUN	0 : 0 : 0
Volumes To Be Created	1
<input checked="" type="checkbox"/> Confirm The Operation	
Submit Reset	

5.3.4.2 Volume Set Migration

Migration occurs when a Volume Set migrates from one RAID level to another, a Volume Set stripe size changes, or when a disk is added to a RAID Set. Migrating status is displayed in the Volume Set status area of the RAIDSet Hierarchy screen during migration.

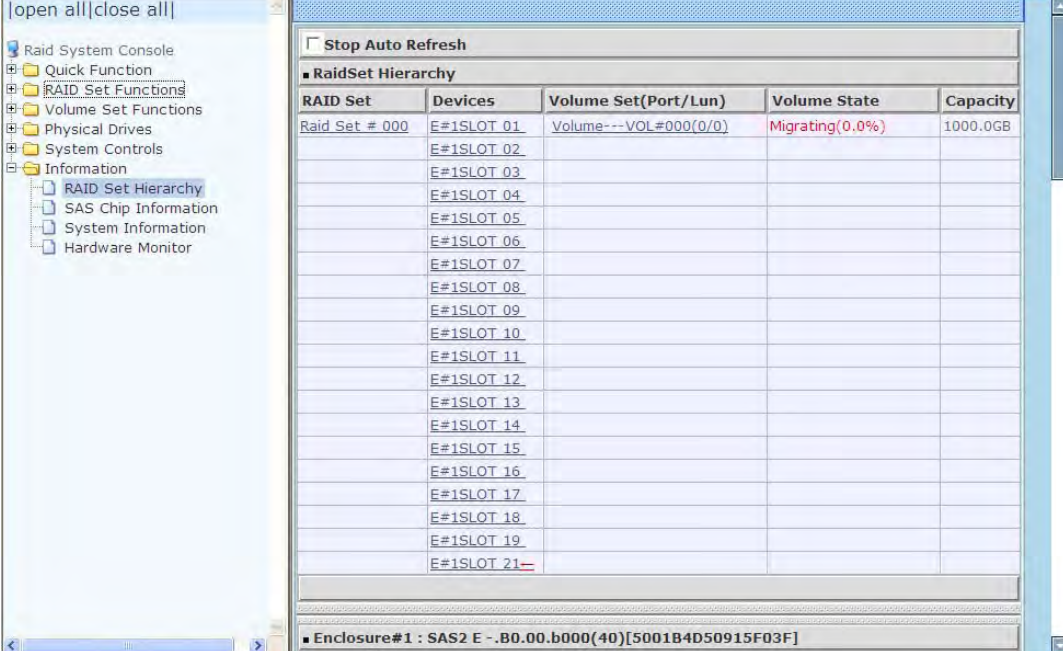

RAID Set	Devices	Volume Set(Port/Lun)	Volume State	Capacity
Raid Set # 000	E#1SLOT 01	Volume--VOL#000(0/0)	Migrating(0.0%)	1000.0GB
	E#1SLOT 02			
	E#1SLOT 03			
	E#1SLOT 04			
	E#1SLOT 05			
	E#1SLOT 06			
	E#1SLOT 07			
	E#1SLOT 08			
	E#1SLOT 09			
	E#1SLOT 10			
	E#1SLOT 11			
	E#1SLOT 12			
	E#1SLOT 13			
	E#1SLOT 14			
	E#1SLOT 15			
	E#1SLOT 16			
	E#1SLOT 17			
	E#1SLOT 18			
	E#1SLOT 19			
	E#1SLOT 21			

Enclosure#1 : SAS2 E -.B0.00.b000(40)[5001B4D50915F03F]



NOTE: The Stripe Size of a RAID30/50/60 Volume Set cannot be modified.

5.3.5 Check Volume Set

Use this function to perform Volume Set consistency check, which verifies the correctness of redundant data (data blocks and parity blocks) in a Volume Set. This basically means computing the parity from the data blocks and comparing the results to the contents of the parity blocks, or computing the data from the parity blocks and comparing the results to the contents of the data blocks.



NOTE: The Volume Set state must be Normal in order to perform Check Volume Set. Only RAID levels with parity (redundant data) such as RAID Levels 3, 5, 6, 30, 50, and 60 support this function.

To perform Check Volume Set function:

1. Click on the **Check Volume Set** link.
2. Tick from the list the Volume Set you want to check. Select the Check Volume Set options.

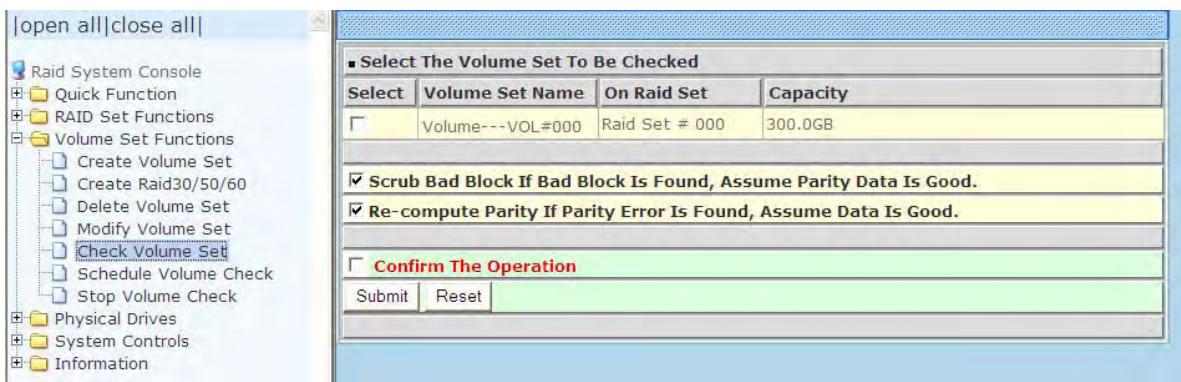

Check Volume Set Options:

- **Scrub Bad Block If Bad Block Found, Assume Parity Data is Good**
- **Re-compute Parity if Parity Error, Assume Data is Good**



NOTE: When the 2 options are not selected, it will only check for errors. It is recommended to perform Check Volume Set with the 2 options unselected at first. If the result shows errors, the data must be backed up to a safe storage. Then the two options can be selected and redo Check Volume Set to correct the errors.

3. Tick on **Confirm The Operation** and click on the **Submit** button. The Checking process will be started.

The checking percentage can also be viewed by clicking on RAIDSet Hierarchy in the Information menu.

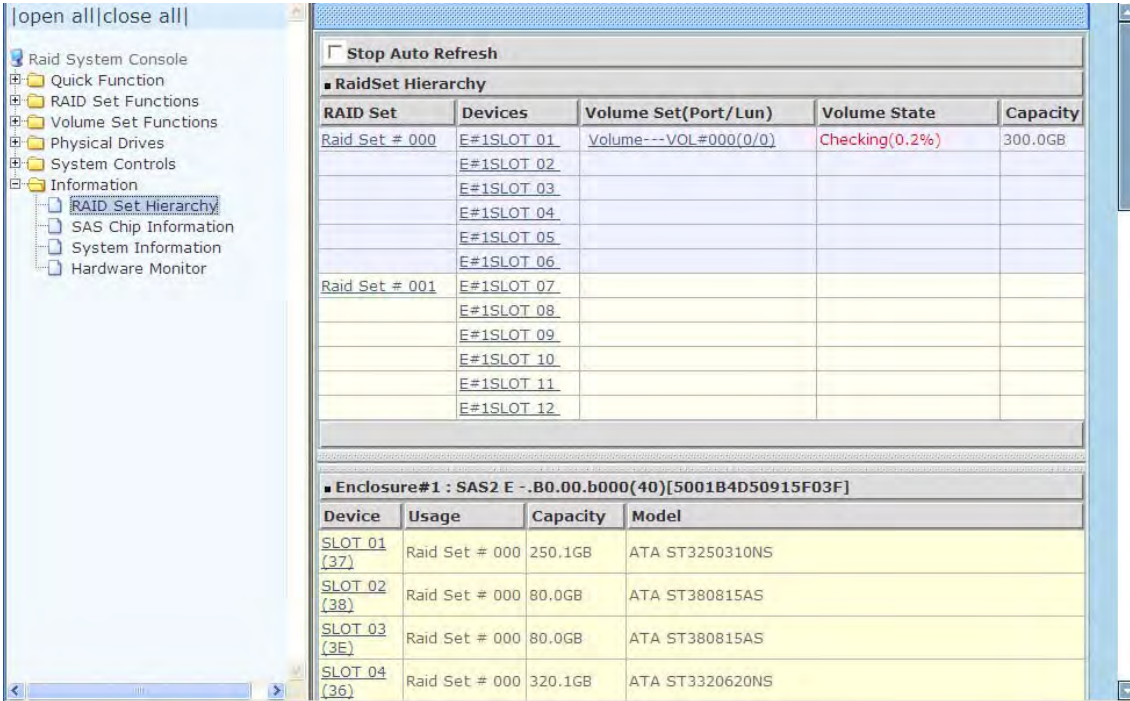

The screenshot shows the RAID System Console interface. On the left is a tree view with 'RAID Set Hierarchy' selected. The main area displays a table for RAID Set Hierarchy and a table for Enclosure#1.

RAID Set	Devices	Volume Set(Port/Lun)	Volume State	Capacity
Raid Set # 000	E#1SLOT 01	Volume---VOL.#000(0/0)	Checking(0.2%)	300.0GB
	E#1SLOT 02			
	E#1SLOT 03			
	E#1SLOT 04			
	E#1SLOT 05			
	E#1SLOT 06			
Raid Set # 001	E#1SLOT 07			
	E#1SLOT 08			
	E#1SLOT 09			
	E#1SLOT 10			
	E#1SLOT 11			
	E#1SLOT 12			

Enclosure#1 : SAS2 E -.B0.00.b000(40)[5001B4D50915F03F]			
Device	Usage	Capacity	Model
SLOT 01 (37)	Raid Set # 000	250.1GB	ATA ST3250310NS
SLOT 02 (38)	Raid Set # 000	80.0GB	ATA ST380815AS
SLOT 03 (3E)	Raid Set # 000	80.0GB	ATA ST380815AS
SLOT 04 (36)	Raid Set # 000	320.1GB	ATA ST3320620NS



NOTE: The result of Check Volume Set function is shown in System Events Information and Volume Set Information. In System Events Information, it is shown in the Errors column. In Volume Set Information, it is shown in Errors Found field.

5.3.6 Schedule Volume Check

To perform Check Volume Set by schedule, follow these steps:

1. Click on the **Schedule Volume Check** link.
2. Select the desired schedule that you wish the Check Volume Set function to run. Tick on **Confirm The Operation** and click on the **Submit** button.

Scheduler: Disabled, 1Day (For Testing), 1Week, 2Weeks, 3Weeks, 4Weeks, 8Weeks, 12Weeks, 16Weeks, 20Weeks and 24Weeks.

Check After System Idle: No, 1 Minute, 3 Minutes, 5 Minutes, 10 Minutes, 15 Minutes, 20 Minutes, 30 Minutes, 45 Minutes and 60 Minutes.

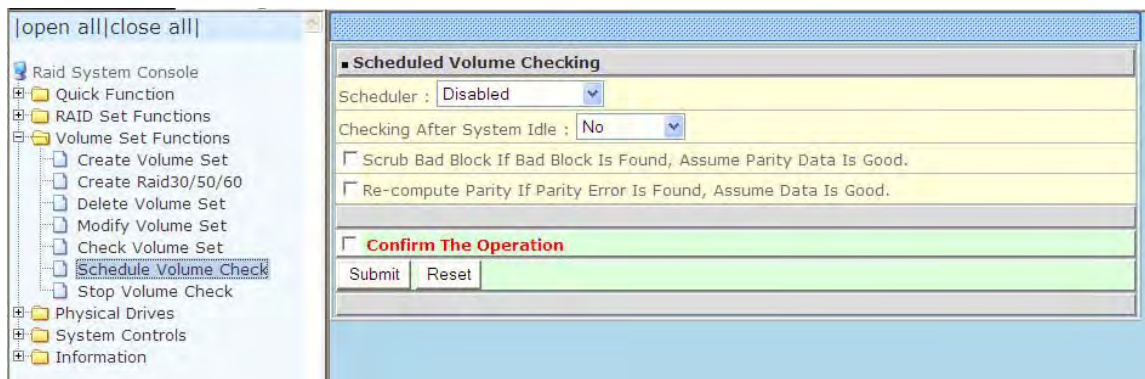

NOTE: To verify the Volume Check schedule, go to **Information -> RAID Set Hierarchy -> select the Volume Set -> the Volume Set Information will be displayed.**

5.3.7 Stop Volume Check

Use this option to stop all Volume Set consistency checking process/processes.

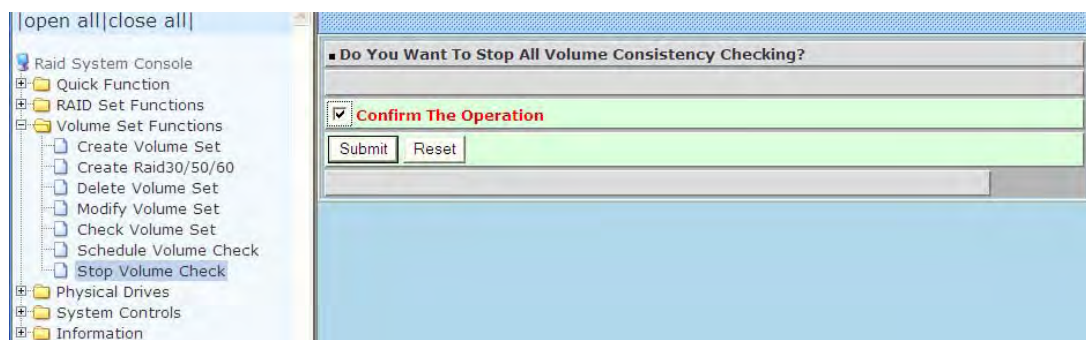

5.4 Physical Drive

Choose this option from the Main Menu to select a disk drive and to perform the functions listed below.

5.4.1 Create Pass-Through Disk

A Pass-Through Disk is a disk drive not controlled by the internal RAID Subsystem firmware and thus cannot be a part of a Volume Set. A Pass-Through disk is a separate and individual RAID Set. The disk is available to the host as an individual disk. It is typically used on a system where the operating system is on a disk not controlled by the RAID controller firmware.

To create pass-through disk, click on the **Create Pass-Through** link under the Physical Drives main menu. The setting function screen appears.

Select the disk drive to be made as Pass-Through Disk and configure the Pass-Through Disk attributes, such as the Cache Mode, Tagged Command Queuing, and SAS Port/LUN Base/LUN for this volume.

The screenshot shows the RAID controller web interface. On the left is a navigation tree with 'Physical Drives' expanded and 'Create Pass-Through Disk' selected. The main area is titled 'Select the IDE drive For Pass Through' and contains two tables of drive information.

Enclosure#1 : SAS2 E -.B0.00.b000		
SLOT 13	250.1GB	ATA ST3250620NS
SLOT 14	320.1GB	ATA ST3320620NS
SLOT 15	250.1GB	ATA ST3250620NS
SLOT 16	250.1GB	ATA ST3250310NS
SLOT 17	250.1GB	ATA ST3250620NS
SLOT 18	80.0GB	ATA ST380815AS
SLOT 19	80.0GB	ATA ST380815AS
SLOT 21	250.1GB	ATA ST3250620NS

Enclosure#2 : SAS2 E -.B0.00.b000		
SLOT 22	320.1GB	ATA ST3320620NS
SLOT 23	320.1GB	ATA ST3320620NS
SLOT 24	250.1GB	ATA ST3250620NS
SLOT 25	250.1GB	ATA ST3250310NS
SLOT 26	250.1GB	ATA ST3250620NS
SLOT 27	80.0GB	ATA ST380815AS
SLOT 28	500.1GB	ATA WDC WD5000AADS-0
SLOT 29	320.1GB	ATA ST3320620NS
SLOT 30	250.1GB	ATA ST3250310NS
SLOT 31	80.0GB	ATA ST380815AS
SLOT 32	250.1GB	ATA ST3250620NS
SLOT 33	250.1GB	ATA ST3250310NS

The second section is titled 'Enter Pass Through Disk Attribute' and contains the following configuration options:

- Volume Cache Mode: Write Back
- Tagged Command Queuing: Enabled
- SAS Port:LUN Base:LUN: 0 : 0 : 2

At the bottom, there is a green bar with a checked box and the text 'Confirm The Operation', and two buttons: 'Submit' and 'Reset'.

5.4.2 Modify a Pass-Through Disk

Use this option to modify the attribute of a Pass-Through Disk. User can modify the Cache Mode, Tagged Command Queuing, and SAS Port/LUN Base/LUN on an existing Pass-Through Disk.

To modify the Pass-Through drive attribute from the Pass-Through drive pool, click on the **Modify a Pass-Through Disk** link. The “Select The Pass-Through Disk For Modification” screen appears. Tick on the Pass-Through Disk from the Pass-Through drive pool and click on the **Submit** button to select the drive.

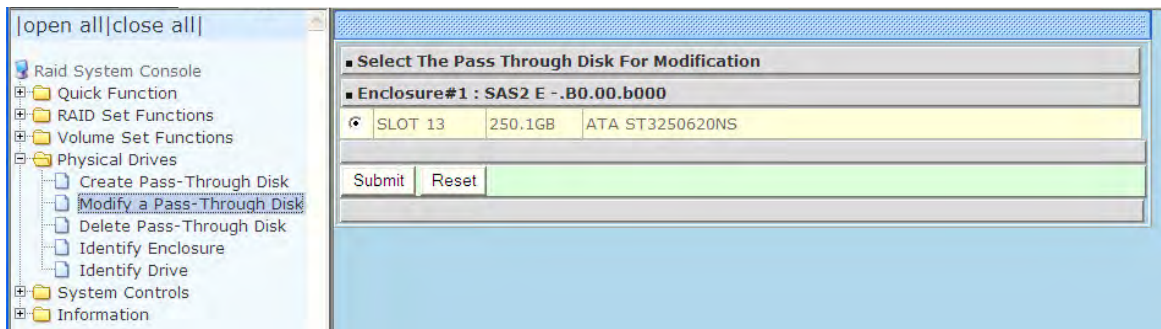

5.4.3 Delete Pass-Through Disk

To delete Pass-Through Disk from the Pass-Through drive pool, click on **Delete Pass-Through** link. Select a Pass-Through Disk, tick on the **Confirm The Operation** and click the **Submit** button to complete the delete action.

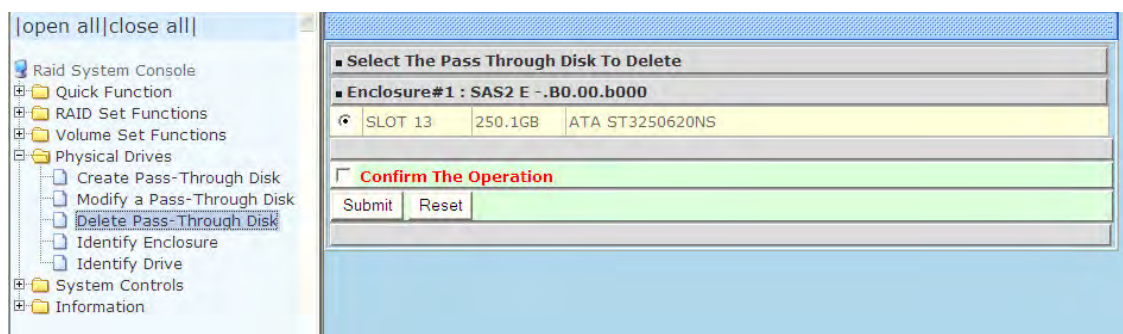

5.4.4 Identify Enclosure

To identify an Enclosure, move the mouse cursor and click on **Identify Enclosure** link. The **Select The Enclosure For Identification** screen appears. Tick on the enclosure from the list of enclosures, then click on the **Submit** button to identify the selected enclosure. All disk drives' LEDs in an enclosure will flash when a particular enclosure is selected.

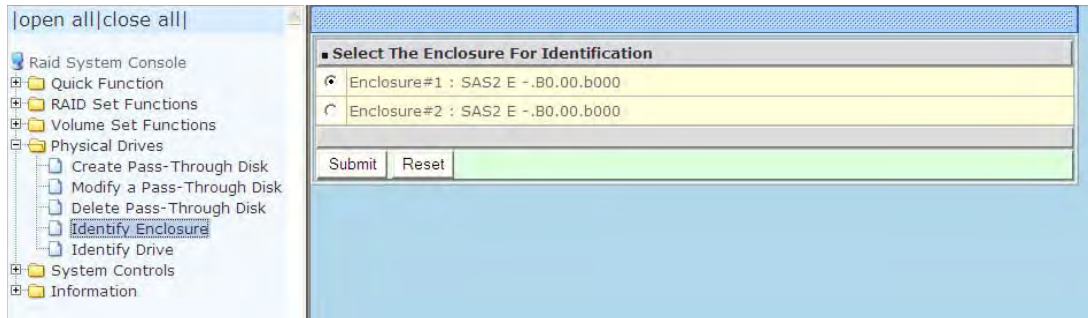

NOTE: When you select Enclosure #1, all disk LED's of disk slots 1 to 21 will be flashing. If you select Enclosure #2, all disk LED's of slots 22 to 42 will be flashing.

5.4.5 Identify Selected Drive

Use this option to physically locate a selected drive to prevent removing the wrong drive. When a disk drive is selected using the **Identify Drive** function, the Status LED of the selected disk drive will be blinking.

To identify a selected drive from the drives pool, click on the **Identify Drive** link. The “Select The IDE Device For identification” screen appears. Tick on the IDE device from the drives list. After completing the selection, click on the **Submit** button to identify selected drive.

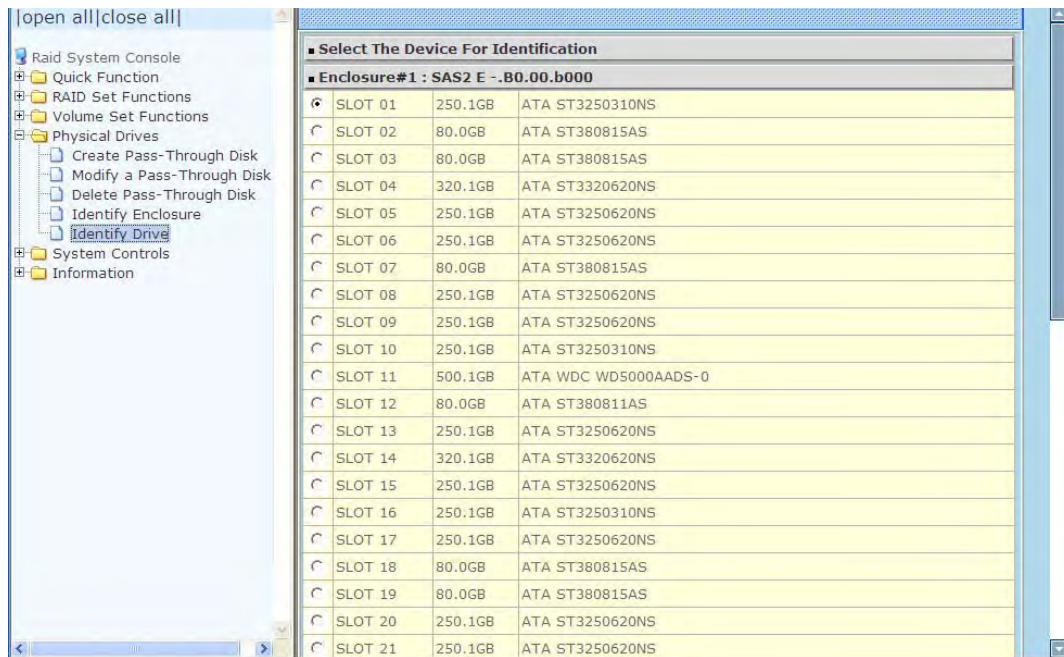

5.5 System Controls

5.5.1 System Configuration

To set the RAID Subsystem configuration options, click the **System Configuration** link under the **System Controls** menu. The System Configurations screen will be shown. Set the desired system option as needed.

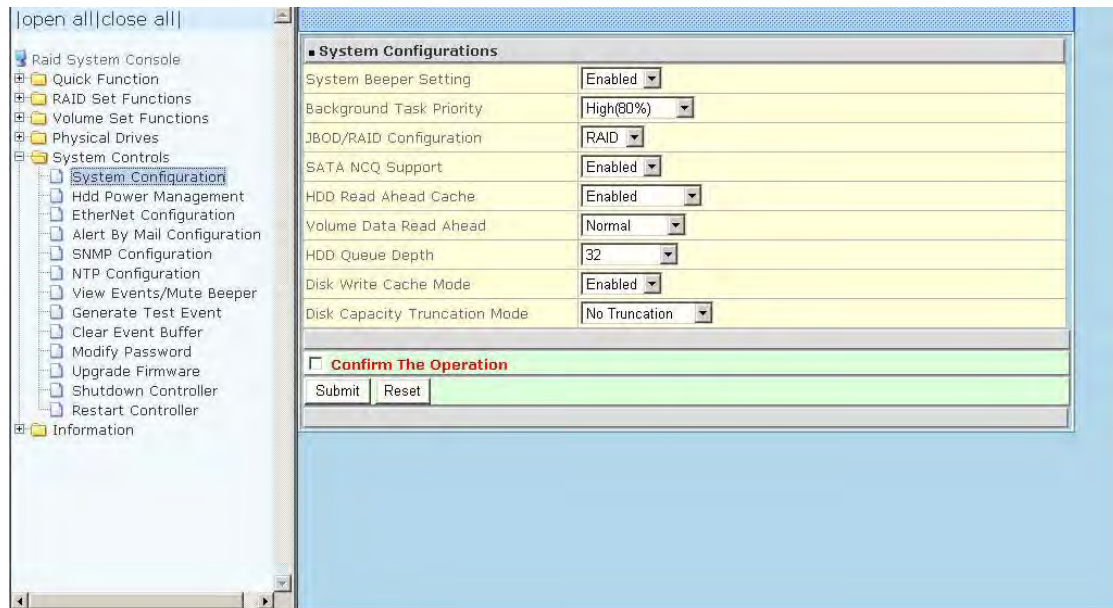

System Beeper Setting:

This option is used to Disable or Enable the system's RAID controller alarm beeper.

Background Task Priority:

The Background Task Priority indicates how much time and system resource the RAID controller devotes to a background task, such as a rebuild operation. The RAID Subsystem allows user to choose the background task priority (High 80%, Medium 50%, Low 25%, and Ultra Low 5%) to balance between background task process and Volume Set access. For high RAID Subsystem performance, specify a low value.

JBOD/RAID Configuration:

The RAID Subsystem supports JBOD and RAID configuration.

SATA NCQ Support:

NCQ is a command protocol in Serial ATA that can only be implemented on native Serial ATA hard drives. It allows multiple commands to be outstanding within a drive at the same time. Drives that support NCQ have an internal queue where outstanding commands can be dynamically rescheduled or re-ordered, along with the necessary

tracking mechanisms for outstanding and completed portions of the workload. Disabled or Enable the SATA NCQ function.

HDD Read Ahead Cache:

This option allows the users to disable the cache of the HDDs on the RAID Subsystem. In some HDD models, disabling the cache in the HDD is necessary to prove the RAID Subsystem functions correctly.

Volume Data Read Ahead:

This option allows the users to set the Volume Data Read Ahead function. Options are: Normal, Aggressive, Conservative, and Disabled.

HDD Queue Depth:

The queue depth is the number of I/O operations that can be run in parallel on a disk drive. HDD Queue Depth options are 1, 2, 4, 8, 16, and 32.

Stagger Power On Control:

This option allows the RAID Subsystem's power supply to power up in succession each HDD in the RAID Subsystem. In the past, all the HDDs on the RAID Subsystem are powered up altogether at the same time. This function allows the power transfer time (lag time) from the last HDD to the next one be set within the range of 0.4 to 6.0 seconds.

Spin Down Idle HDD (Minutes):

This option enables the hard drives to spin down after they become idle after a preset period of time. Options are: Disabled, 1 (For Test), 3, 5, 10, 15, 20, 30, 40, and 60.

Disk Write Cache Mode:

The RAID Subsystem supports Disk Write Cache Mode options: Auto, Enabled, and Disabled. If the RAID Subsystem has BBM (battery backup module), selecting the Auto option will automatically enable Disk Write Cache. On the other hand, if there is no BBM, the Auto option will disable Disk Write Cache.

Disk Capacity Truncation Mode:

The RAID Subsystem uses drive truncation so that drives from different vendors are more likely to be able to be used as spares for each other. Drive truncation slightly decreases the usable capacity of a drive that is used in the subsystem. Options are:

Multiples Of 10G: If you have several 120GB drives from different vendors, chances are that the capacity varies slightly. For example, one drive might be 121.1 GB, and the other 120.4 GB. This drive truncation mode makes the 121.1 GB and 120.4 GB drives same capacity as 120 GB so that one could replace the other.

Multiples Of 1G: If you have 120 GB drives from different vendors, chances are that the capacity varies slightly. For example, one drive might be 121.1 GB, and the other 121.4 GB. This drive truncation mode makes the 121.1 GB and 121.4 GB drives same capacity 121 GB so that one could replace the other.

No Truncation: The capacity of the disk drive is not truncated.

5.5.2 HDD Power Management

MAID (**M**assive **A**rray of **I**dle **D**isks) is a storage technology that employs a large group of disk drives in which only those drives in active use are spinning at any given time.

This reduces power consumption and prolongs the lives of the drives.

MAID is designed for Write Once, Read Occasionally (WORO) applications such as Data Backup, Document, Mail server, and so on.

MAID technology focuses on "Green Storage Concept" to save power consumption and enhance disk drives effective usage, i.e., "disk drives are spun down when there is no activity or I/O on the drives".

In the RAID subsystem, MAID is implemented in the **HDD Power Management** menu. Using the **Advanced Power Management (APM)** function of disk drives, HDD Power Management has three options (MAID Levels): (Level 1) Place idle drives in Lower Power Mode, where the drives' heads are unloaded; (Level 2) Place idle drives in Low RPM Mode, where drives' heads are unloaded and slows down to around 4000 RPM; and (Level 3) Spin down idle drives, where drives stops spinning and goes into sleep mode.

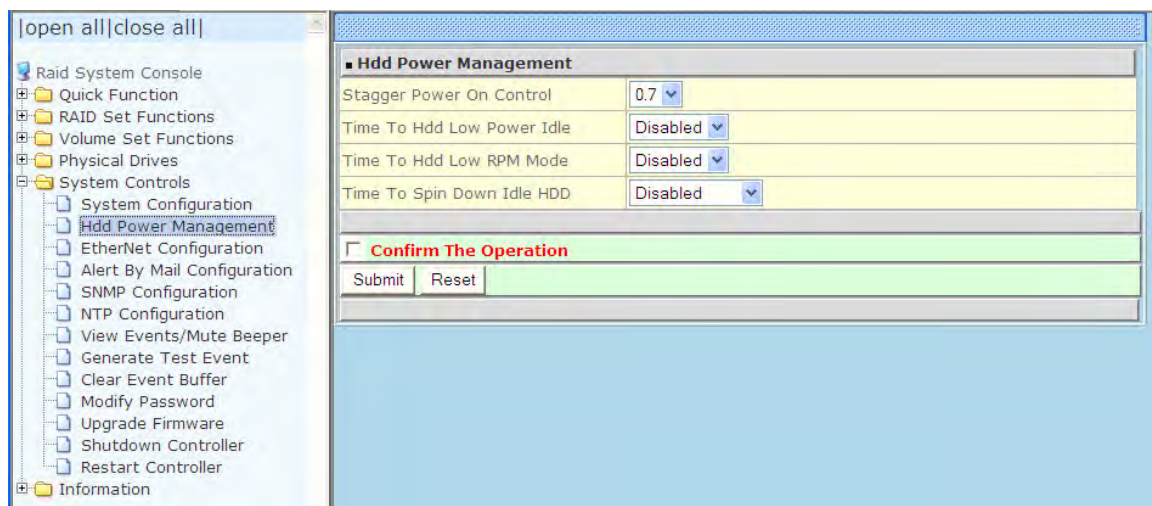

Stagger Power On Control:

This option allows the RAID subsystem's power supply to power up in succession each HDD in the RAID subsystem. In the past, all the HDDs on the RAID subsystem are powered up altogether at the same time. This function allows the power transfer time (lag time) from the last HDD to the next one be set within the range of 0.4 to 6.0 seconds. Default is 0.7 seconds.

Time to HDD Low Power Idle: (MAID Level 1)

This option enables the RAID subsystem to place idle HDDs of a RAID Set in Low Power Mode, where drives' heads are unloaded. The power consumption of the Idle HDD saving is around 15% to 20%. Recovery time is under a second.

Options are: Disabled, 2, 3, 4, 5, 6, and 7 (Minutes).

Time to HDD Low RPM Mode: (MAID Level 2)

This option enables the RAID subsystem to place idle HDDs of a RAID Set in Low RPM Mode, where drives' heads are unloaded and drive platters speed is reduced to around 4000 RPM. The power consumption of the Idle HDD saving is from 35% to 45%. Recovery time is 15 seconds.

Options are: Disabled, 10, 20, 30, 40, 50, and 60 (Minutes).

Time to Spin Down Idle HDD: (MAID Level 3)

This option enables the RAID subsystem to spin down HDDs of a RAID Set after they become idle after a preset period of time. In this level, the drives stop spinning and go into sleep mode. The power consumption of the Idle HDD saving is from 60% to 70%. Recovery time is 30 to 45 seconds.

Options are: Disabled, 1 (For Test), 3, 5, 10, 15, 20, 30, 40, and 60 (Minutes).



NOTE: To verify if the disk drive you use supports APM, select RAIDSet Hierarchy and click the disk drive (E# Slot#) link. In the Device Information screen, check the Disk APM Support if "Yes".

5.5.3 EtherNet Configuration

To set the Ethernet configuration, click the **EtherNet Configuration** link under the System Controls menu. The EtherNet Configuration screen will be shown. Set the desired configuration. Once done, tick on the **Confirm The Operation** and click the **Submit** button to save the settings.

Ether Net Configurations	
DHCP Function	Enabled
Local IP Address (Used If DHCP Disabled)	192 .168 .1 .168
Gateway IP Address (Used If DHCP Disabled)	0 .0 .0 .0
Subnet Mask (Used If DHCP Disabled)	255 .255 .255 .0
HTTP Port Number (7168..8191 Is Reserved)	80
Telnet Port Number (7168..8191 Is Reserved)	23
SMTP Port Number (7168..8191 Is Reserved)	25
Current IP Address	192.168.0.133
Current Gateway IP Address	192.168.0.1
Current Subnet Mask	255.255.255.0
Ether Net MAC Address	00.1B.4D.01.A9.22
<input checked="" type="checkbox"/> Confirm The Operation	
Submit Reset	



NOTE: If HTTP, Telnet and SMTP Port Number is set to "0", the service is disabled.

5.5.4 Alert By Mail Configuration

To set the Event Notification function, click on the **Alert By Mail Configuration** link under the System Controls menu. The Event Notification configuration screen will be shown. Set up the desired function and option. When an abnormal condition occurs, an error message will be emailed to the email recipient(s) that a problem has occurred. Events are classified into 4 levels (Urgent, Serious, Warning, and Information).

SMTP Server Configuration	
SMTP Server IP Address	0 . 0 . 0 . 0

Mail Address Configurations	
Sender Name :	Mail Address :
Account :	Password :

Event Notification Configurations	
MailTo Name1 :	Mail Address :
<input checked="" type="radio"/> Disable Event Notification	No Event Notification Will Be Sent
<input type="radio"/> Urgent Error Notification	Send Only Urgent Event
<input type="radio"/> Serious Error Notification	Send Urgent And Serious Event
<input type="radio"/> Warning Error Notification	Send Urgent, Serious And Warning Event
<input type="radio"/> Information Notification	Send All Event
<input type="checkbox"/> Notification For No Event	Notify User If No Event Occurs Within 24 Hours
MailTo Name2 :	Mail Address :
<input checked="" type="radio"/> Disable Event Notification	No Event Notification Will Be Sent
<input type="radio"/> Urgent Error Notification	Send Only Urgent Event
<input type="radio"/> Serious Error Notification	Send Urgent And Serious Event
<input type="radio"/> Warning Error Notification	Send Urgent, Serious And Warning Event
<input type="radio"/> Information Notification	Send All Event
<input type="checkbox"/> Notification For No Event	Notify User If No Event Occurs Within 24 Hours
MailTo Name3 :	Mail Address :
<input checked="" type="radio"/> Disable Event Notification	No Event Notification Will Be Sent



NOTE: If Event Notification by email is enabled, every 30 of event log will be sent to the email recipient(s) as one package log.

NOTE: If different email recipients are setup, the event notification levels for each email recipient can be configured differently. For example, first email recipient can be configured with "Urgent Error Notification" while second email recipient can be configured with "Serious Error Notification".

5.5.5 SNMP Configuration

The SNMP gives users independence from the proprietary network management schemes of some manufacturers and SNMP is supported by many WAN and LAN manufacturers enabling true LAN/ WAN management integration.

To set the SNMP function, move the cursor to the main menu and click on the **SNMP Configuration** link. The SNMP Configurations screen will be shown. Select the desired function and set the preferred option.

SNMP Trap Configurations			
SNMP Trap IP Address #1	0 . 0 . 0 . 0	Port#	162
SNMP Trap IP Address #2	0 . 0 . 0 . 0	Port#	162
SNMP Trap IP Address #3	0 . 0 . 0 . 0	Port#	162

SNMP System Configurations	
Community	
sysContact.0	
sysName.0	
sysLocation.0	

SNMP Trap Notification Configurations	
<input checked="" type="radio"/> Disable SNMP Trap	No SNMP Trap Will Be Sent
<input type="radio"/> Urgent Error Notification	Send Only Urgent Event
<input type="radio"/> Serious Error Notification	Send Urgent And Serious Event
<input type="radio"/> Warning Error Notification	Send Urgent, Serious And Warning Event
<input type="radio"/> Information Notification	Send All Event

Confirm The Operation

Submit Reset

SNMP Trap Configurations: Type in the SNMP Trap IP Address box the IP address of the host system where SNMP traps will be sent. The SNMP Port is set to 162 by default.

SNMP System Configuration:

Community: Type the SNMP community. The default is public.

(1) **sysContact.0**, (2) **sysLocation.0**, and (3) **sysName.0**: SNMP parameter (31 bytes max). If these 3 categories are configured and when an event occurs, SNMP will send out a message that includes the 3 categories within the message. This allows user to easily define which RAID unit is having problem.

SNMP Trap Notification Configurations: Select the desired option.

After completing the settings, tick on the **Confirm The Operation** and click on the **Submit** button to save the configuration.

SNMP also works in the same as Alert By Mail when sending event notifications.

5.5.6 NTP Configuration

NTP stands for **Network Time Protocol**. It is an Internet protocol used to synchronize the clocks of computers to some time reference. Type the NTP Server IP Address to enable the RAID Subsystem to synchronize with it.

To set the NTP function, move the cursor to the main menu and click on the **NTP Configuration** link. The NTP Configuration screen will be displayed. Select the desired function and configure the necessary option.

After completing the settings, tick on the **Confirm The Operation** and click on the **Submit** button to save the configuration.

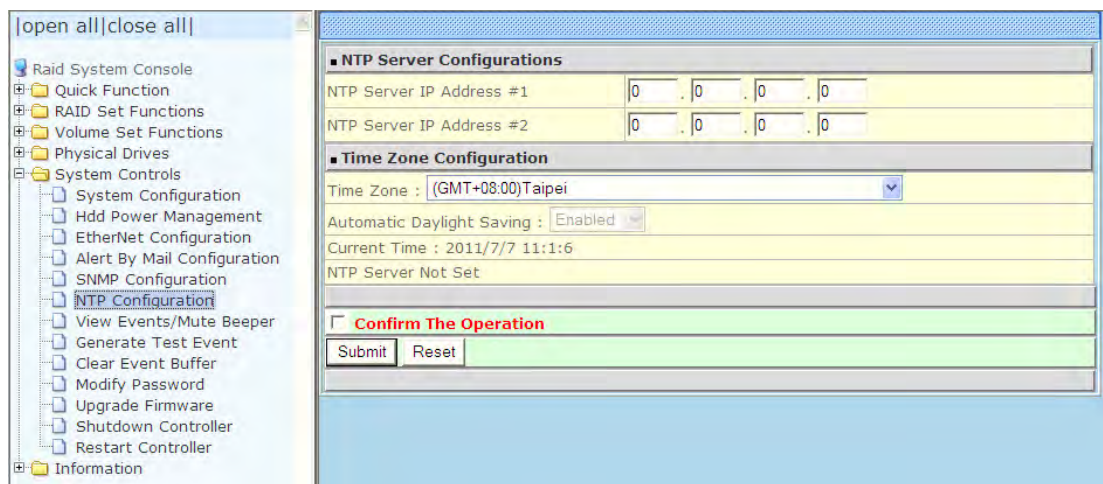

5.5.7 View Events / Mute Beeper

To view the RAID Subsystem's event log information, move the mouse cursor to the System Controls menu and click on the **View Events/Mute Beeper** link. The System Events Information screen appears.

The System Events Information screen will show: Time, Device, Event type, Elapse Time and Errors.

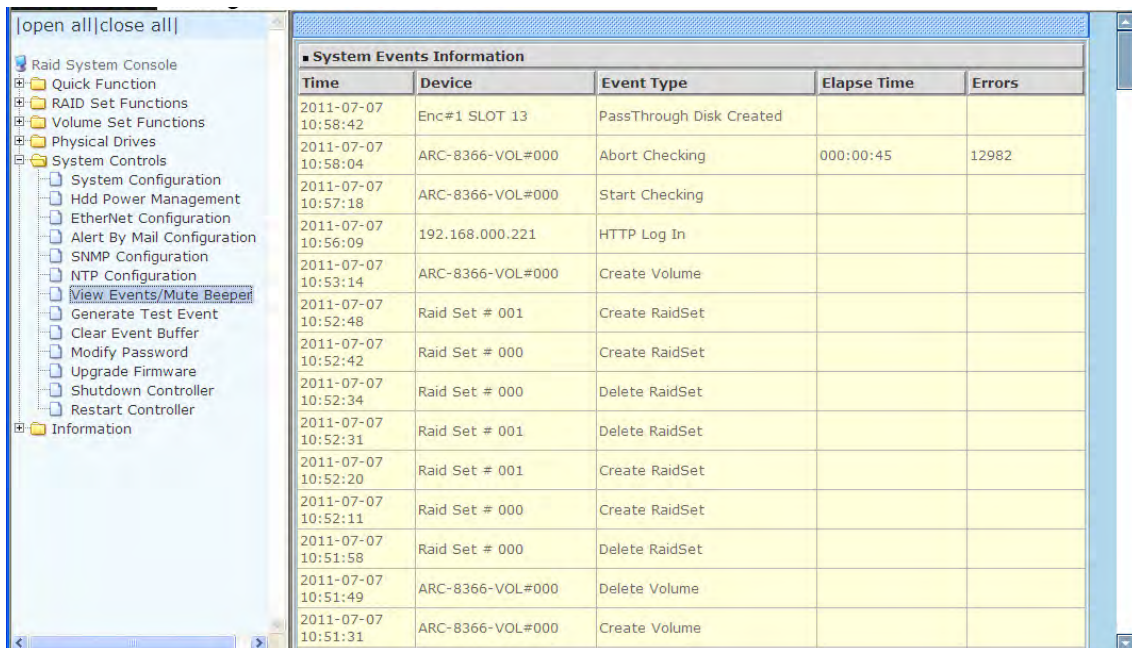

System Events Information				
Time	Device	Event Type	Elapse Time	Errors
2011-07-07 10:58:42	Enc#1 SLOT 13	PassThrough Disk Created		
2011-07-07 10:58:04	ARC-8366-VOL#000	Abort Checking	000:00:45	12982
2011-07-07 10:57:18	ARC-8366-VOL#000	Start Checking		
2011-07-07 10:56:09	192.168.000.221	HTTP Log In		
2011-07-07 10:53:14	ARC-8366-VOL#000	Create Volume		
2011-07-07 10:52:48	Raid Set # 001	Create RaidSet		
2011-07-07 10:52:42	Raid Set # 000	Create RaidSet		
2011-07-07 10:52:34	Raid Set # 000	Delete RaidSet		
2011-07-07 10:52:31	Raid Set # 001	Delete RaidSet		
2011-07-07 10:52:20	Raid Set # 001	Create RaidSet		
2011-07-07 10:52:11	Raid Set # 000	Create RaidSet		
2011-07-07 10:51:58	Raid Set # 000	Delete RaidSet		
2011-07-07 10:51:49	ARC-8366-VOL#000	Delete Volume		
2011-07-07 10:51:31	ARC-8366-VOL#000	Create Volume		

This function is also used to silence the beeper alarm.

5.5.8 Generate Test Event

If you want to generate test events, move the cursor bar to the main menu and click on the **Generate Test Event** Link. Tick on the **Confirm The Operation** and click on the **Submit** button. Then click on the **View Events/Mute Beeper** to view the test event.

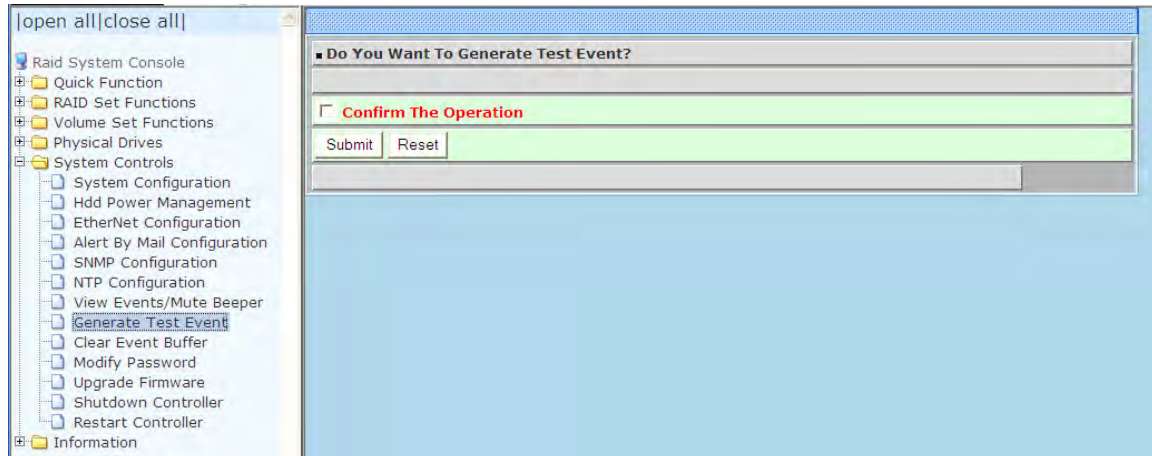

5.5.9 Clear Event Buffer

Use this feature to clear the RAID Subsystem's System Events Information buffer.

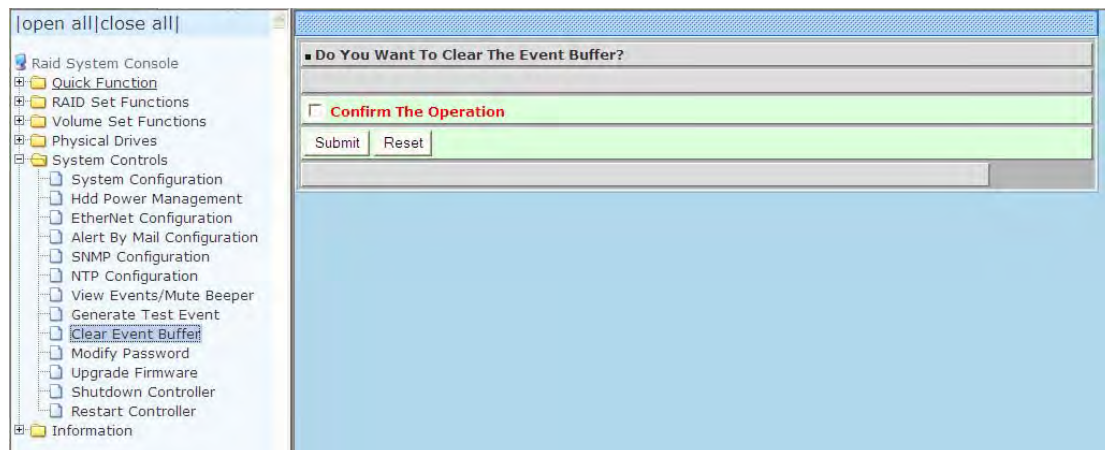

5.5.10 Modify Password

To change or disable the RAID Subsystem's admin password, click on the **Modify Password** link under the **System Controls** menu. The Modify System Password screen appears.

The factory-default admin password is set to **00000000**. Once the password has been set, the user or administrator can only monitor and configure the RAID Subsystem by providing the correct password.

The password is used to protect the RAID Subsystem's configuration from unauthorized access. The RAID controller will check the password only when entering the Main Menu from the initial screen. The RAID Subsystem will automatically go back to the initial screen when it does not receive any command after sometime.

To disable the password, enter only the original password in the **Enter Original Password** box, and leave both the **Enter New Password** and **Re-Enter New Password** boxes blank. After selecting the **Confirm The Operation** option and clicking the **Submit** button, the system password checking will be disabled. No password checking will occur when entering the main menu from the starting screen.

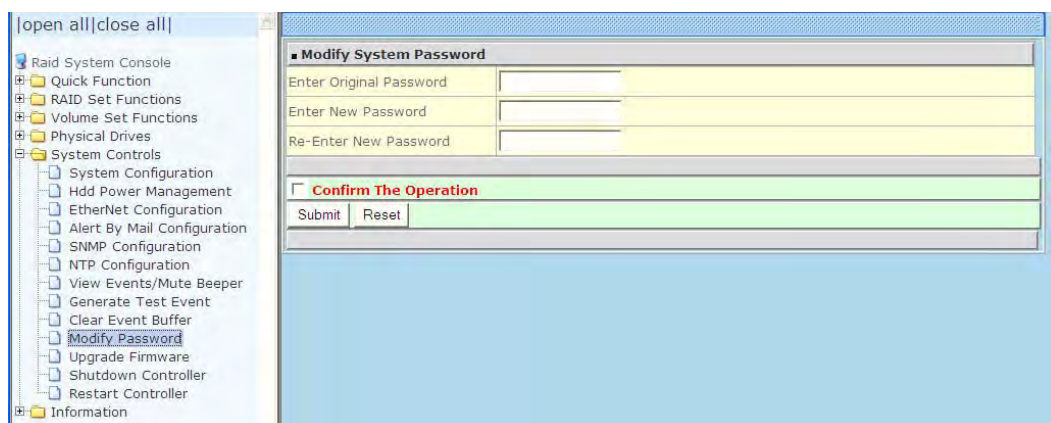

NOTE: The admin Password characters allowed are 'A' – 'Z', 'a' – 'z', and '0' – '9'. The minimum number of Password characters is null/empty (Password is disabled) and maximum number of Password characters is 15.

5.5.11 Upgrade Firmware

Please refer to Section 6.2 for more information.

5.5.12 Shutdown Controller

Use this function to shutdown the RAID Controller. This is used to flush the data from the cache memory, and is normally done before powering off the system power switch.

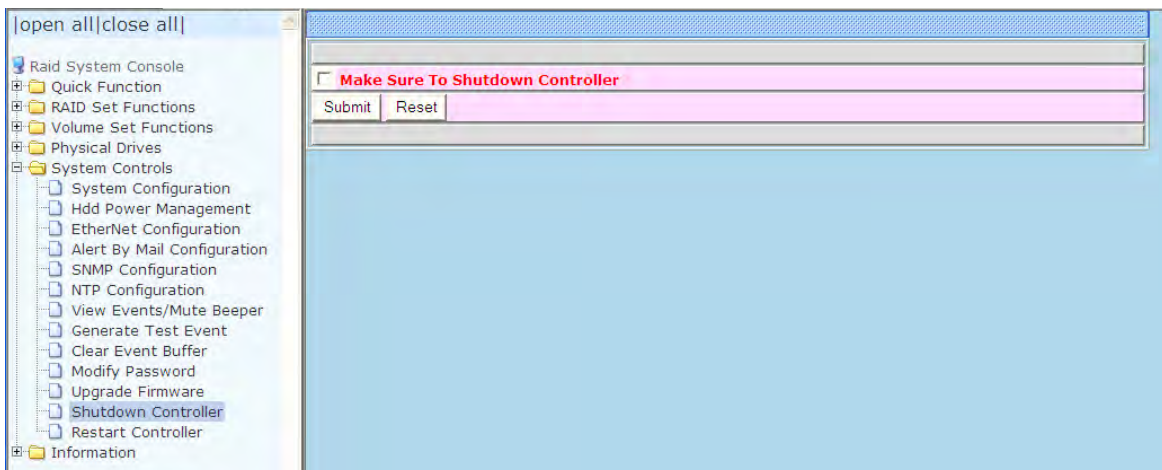
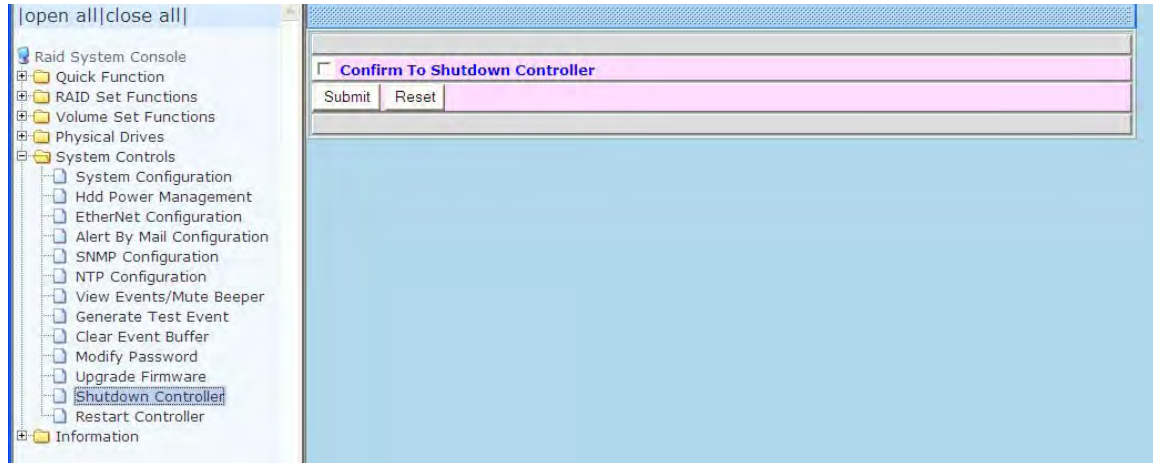

5.5.13 Restart Controller

Use this function to restart the RAID Controller.

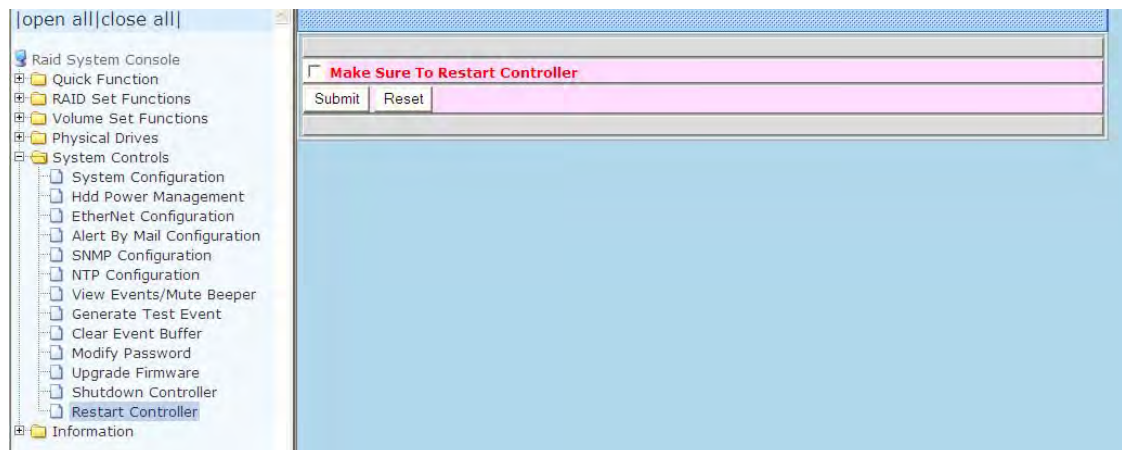
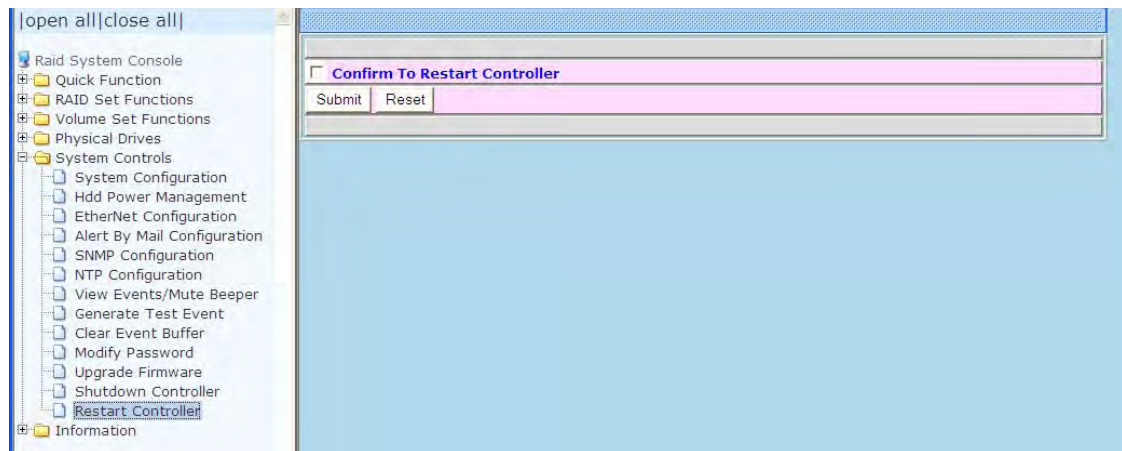

5.6 Information Menu

5.6.1 RAID Set Hierarchy

Use this feature to view the RAID Subsystem's existing RAID Set(s), Volume Set(s) and disk drive(s) configuration and information. Select the **RAID Set Hierarchy** link from the **Information** menu to display the RAID Set Hierarchy screen.

The screenshot shows the RAID Set Hierarchy screen. On the left is a tree view with the following structure:

- open all|close all|
 - Raid System Console
 - Quick Function
 - RAID Set Functions
 - Volume Set Functions
 - Physical Drives
 - System Controls
 - Information
 - RAID Set Hierarchy**
 - SAS Chip Information
 - System Information
 - Hardware Monitor

The main area displays the RAID Set Hierarchy table:

RAID Set	Devices	Volume Set(Port/Lun)	Volume State	Capacity
Raid Set # 000	E#1SLOT 01	Volume---VOL#000(0/0)	Normal	300.0GB
	E#1SLOT 02			
	E#1SLOT 03			
	E#1SLOT 04			
	E#1SLOT 05			
	E#1SLOT 06			
Raid Set # 001	E#1SLOT 07			
	E#1SLOT 08			
	E#1SLOT 09			
	E#1SLOT 10			
	E#1SLOT 11			
	E#1SLOT 12			
Raid Set # 002	E#1SLOT 13	ST3250620NS (0/1)	Normal	250.1GB

Below the RAID Set Hierarchy table is the Enclosure#1 table:

Enclosure#1 : SAS2 E -.B0.00.b000(40)[5001B4D50915F03F]			
Device	Usage	Capacity	Model
SLOT 01(37)	Raid Set # 000	250.1GB	ATA ST3250310NS
SLOT 02(38)	Raid Set # 000	80.0GB	ATA ST380815AS
SLOT 03(3E)	Raid Set # 000	80.0GB	ATA ST380815AS
SLOT 04(36)	Raid Set # 000	320.1GB	ATA ST3320620NS
SLOT 05(3F)	Raid Set # 000	250.1GB	ATA ST3250620NS
SLOT 06(3C)	Raid Set # 000	250.1GB	ATA ST3250620NS
SLOT 07(3D)	Raid Set # 001	80.0GB	ATA ST380815AS

To view the RAID Set information, click the **RAID Set #** link from the RAID Set Hierarchy screen. The RAID Set Information screen appears.

To view the disk drive information, click the **Slot#** link from the RAID Set Hierarchy screen. The Disk Information screen appears. This screen shows various information such as timeout count, media error count, and SMART information.

To view the Volume Set information, click the **Volume---VOL#** link from the RAID Set Hierarchy screen. The Volume Set Information screen appears.

5.6.2 SAS Chip Information

To view the SAS Chip Information of the RAID Controller, click the link SAS Chip Information.

Controller:EP-4423S 1.49	
SAS Address	5001B4D01A922000
Component Vendor	LSI
Component ID	0064
Enclosure	
Number Of Phys	16
Attached Expander	Expander#1[5001B4D50A78E03F][8x6G]
Expander#1:SAS2 E -.BD.00.bd00	
SAS Address	5001B4D50A78E03F
Component Vendor	LSI
Component ID	0221
Enclosure	
Number Of Phys	30
Attached Expander	Expander#2[5001B4D50913203F][4x6G]
Attached Expander	Expander#3[5001B4D50915F03F][4x6G]
Attached Expander	Controller[5001B4D01A922000][8x6G]
Expander#2:SAS2 E -.B0.00.b000	
SAS Address	5001B4D50913203F
Component Vendor	LSI
Component ID	0221
Enclosure	ENC#2
Number Of Phys	30
Attached Expander	Expander#1[5001B4D50A78E03F][4x6G]
Expander#3:SAS2 E -.B0.00.b000	
SAS Address	5001B4D50915F03F

The SAS Address, Component Vendor, Component ID, Enclosure number, Number of Phys, and Attached Expander information will be shown.

5.6.3 System Information

To view the RAID subsystem's controller information, click the **System Information** link from the **Information** menu. The RAID Subsystem Information screen appears.

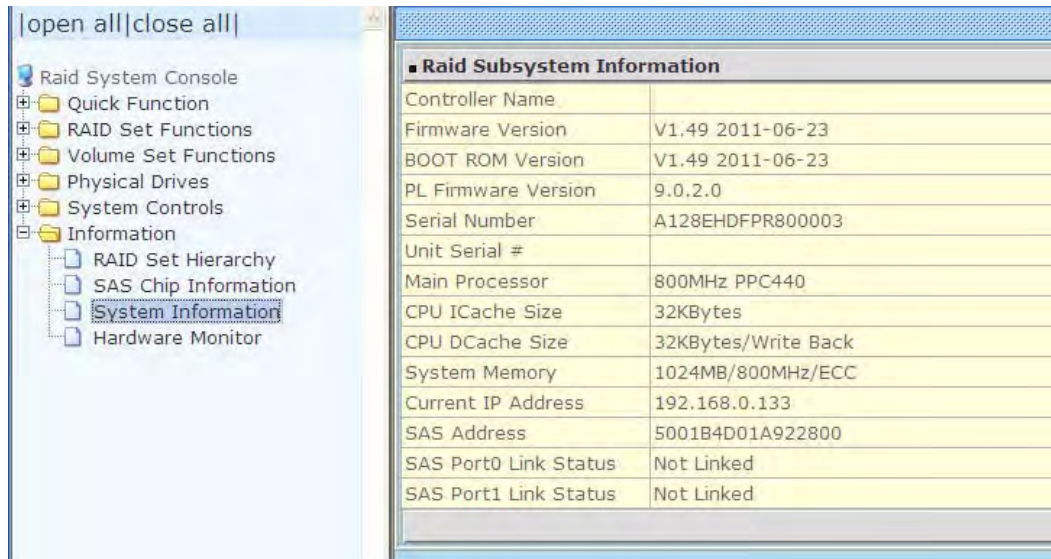

■ RAID Subsystem Information	
Controller Name	
Firmware Version	V1.49 2011-06-23
BOOT ROM Version	V1.49 2011-06-23
PL Firmware Version	9.0.2.0
Serial Number	A128EHDFPR800003
Unit Serial #	
Main Processor	800MHz PPC440
CPU ICache Size	32KBytes
CPU DCache Size	32KBytes/Write Back
System Memory	1024MB/800MHz/ECC
Current IP Address	192.168.0.133
SAS Address	5001B4D01A922800
SAS Port0 Link Status	Not Linked
SAS Port1 Link Status	Not Linked

The Controller Name, Firmware Version, Serial Number, BOOT ROM Version, PL Firmware Version, Serial #, Main Processor, CPU ICache size, CPU DCache size, System Memory, Current IP Address, SAS Address, SAS Port0 Link Status, and SAS Port1 Link Status appear in this screen.

5.6.4 Hardware Monitor

To view the RAID Subsystem's hardware information, click the **Hardware Monitor** link from the **Information** menu. The Hardware Monitor Information screen appears.

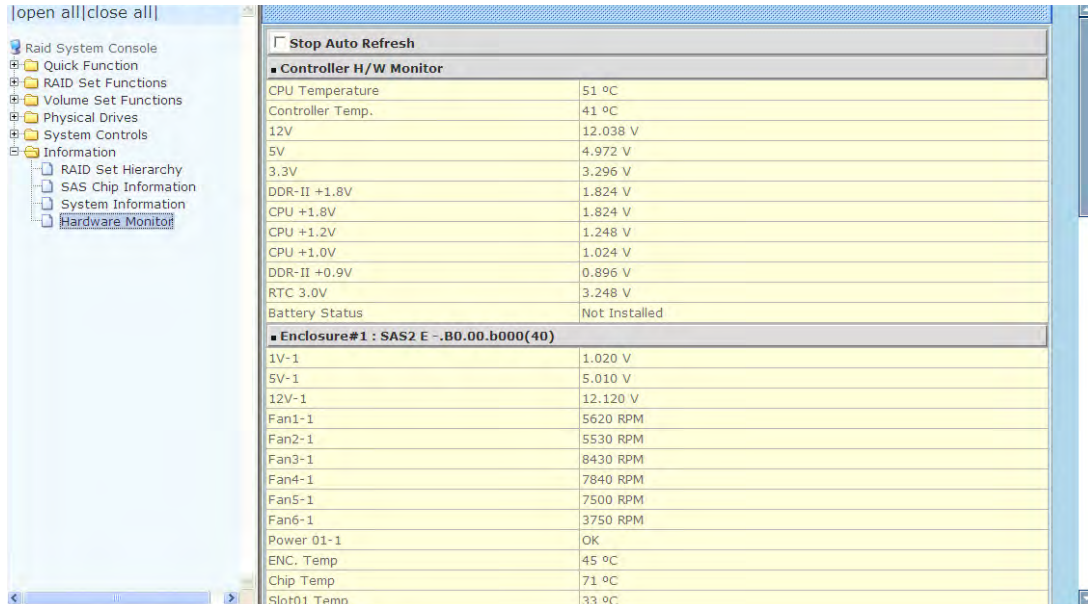

The Hardware Monitor Information provides the temperature, fan speed, power supply status and voltage levels of the RAID Subsystem. All items are also unchangeable. When the threshold values are surpassed, warning messages will be indicated through the LCD, LED and alarm buzzer.

Item	Warning Condition
Controller Board Temperature	> 90 Celsius
HDD Temperature	> 65 Celsius
Controller Board Temperature	> 70 Celsius
Fan Speed	< 1500 RPM
Power Supply +12V	< 10.5V or > 13.5V
Power Supply +5V	< 4.7V or > 5.4V
Power Supply +3.3V	< 3.0V or > 3.6V
DDR Supply Voltage +2.5V	< 2.25V or > 2.75V
CPU Core Voltage +1.3V	< 1.17V or > 1.43V
DDR Termination Power +1.25V	< 1.125V or > 1.375V

Chapter 6 Maintenance

6.1 Upgrading the RAID Controller's Cache Memory

The RAID controller is equipped with one DDRII SDRAM socket. By default, the RAID controller comes with at least 1GB of memory that is expandable to a maximum of 4GB. The expansion memory module can be purchased from your dealer.

Memory Type: 1.8V DDR2-800 Registered ECC SDRAM 240pin

Memory Size: Supports 240pin DDR2 of 2GB or 4GB.

6.1.1 Replacing the Memory Module

1. Shutdown the RAID controller by turning off the Main Switch.
2. When RAID Subsystem is already shutdown, power off the switches of the 2 Power Supply Fan Modules. Then disconnect the power cables.
3. Disconnect any SAS cable from the controller module, and then remove the Controller Module from the slot.
4. Remove the memory module from the RAM socket of the RAID controller by pressing the ejector clips until the memory module pops out of the socket.
5. Align the new memory module into the socket. Make sure the notch is aligned with the key on the socket itself. With the ejector clips in open position, press down the memory module into the socket until it sinks into place. The ejector clips will automatically close to lock the memory module.
6. Reinsert the Controller Module.
7. If the RAID Subsystem has dual (redundant) RAID controllers, repeat Steps 3 to 6 to replace/upgrade the memory of the other Controller Module.
8. Reconnect the SAS cable(s) to the Controller Module(s). Reconnect the power cables and power on the 2 switches of the Power Supply Fan Modules.
9. Turn on the Main Switch of the RAID Subsystem.

6.2 Upgrading the RAID Controller's Firmware

Upgrading Firmware Using Flash Programming Utility

Since the RAID Subsystem's controller features flash firmware, it is not necessary to change the hardware flash chip in order to upgrade the controller firmware. User can simply re-program the old firmware through the RS-232 port. New releases of the firmware are available in the form of binary file at vendor's FTP. The file available at the FTP site is usually a self-extracting file that contains the following:

XXXXVVV.BIN Firmware Binary (where "XXXX" refers to the model name and "VVV" refers to the firmware version)

README.TXT It contains the history information of the firmware change. Read this file first before upgrading the firmware.

These files must be extracted from the compressed file and copied to one directory in the host computer.

Establishing the Connection

The firmware can be downloaded to the RAID subsystem's controller using Telnet program with ZMODEM upload protocol, or via web browser-based RAID Manager remote management page.

With Telnet, you must complete the appropriate installation and configuration procedure before proceeding with the firmware upgrade. The Telnet program must support the ZMODEM file transfer protocol.

Web browser-based RAID Manager can be used to update the firmware. A web browser must have been setup before proceeding with the firmware upgrade.

Upgrading Firmware Through Telnet



NOTE: This example uses CRT terminal emulation program. For easier upgrade procedure, it is recommended to use web browser-based firmware upgrade.

1. To connect to RAID subsystem using Telnet, open Terminal Emulation program (example, CRT 6.1) Refer to Section 4.1 for sample step to enable Telnet connection via CRT program.
2. After successful connection, select **RAID System Function** menu. The Password box will be shown. Enter the password (default is 00000000) to login.

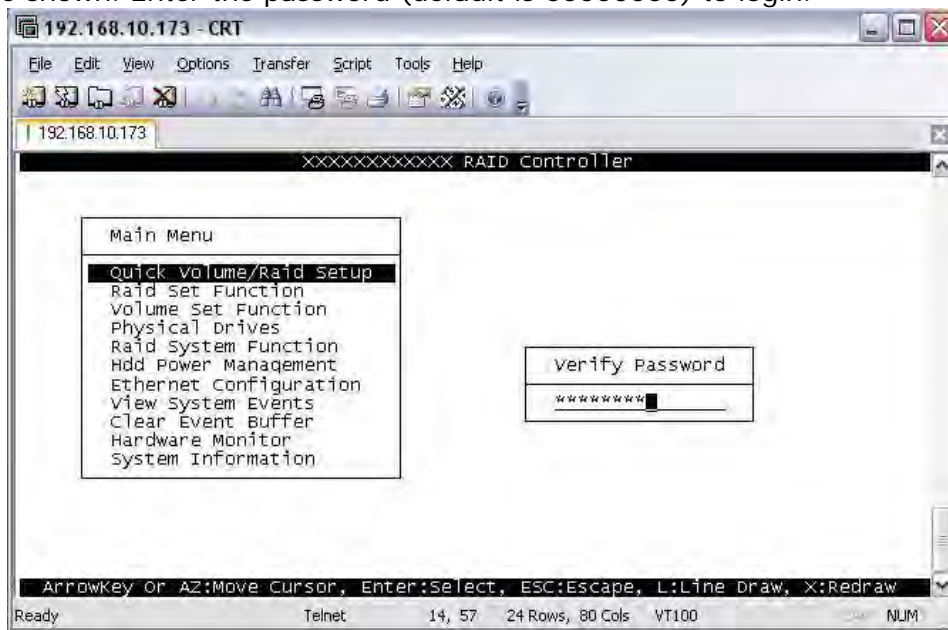

3. After login to RAID System Function menu, select **Update Firmware**. Then choose "Transfer" menu and select "Zmodem Upload List...".

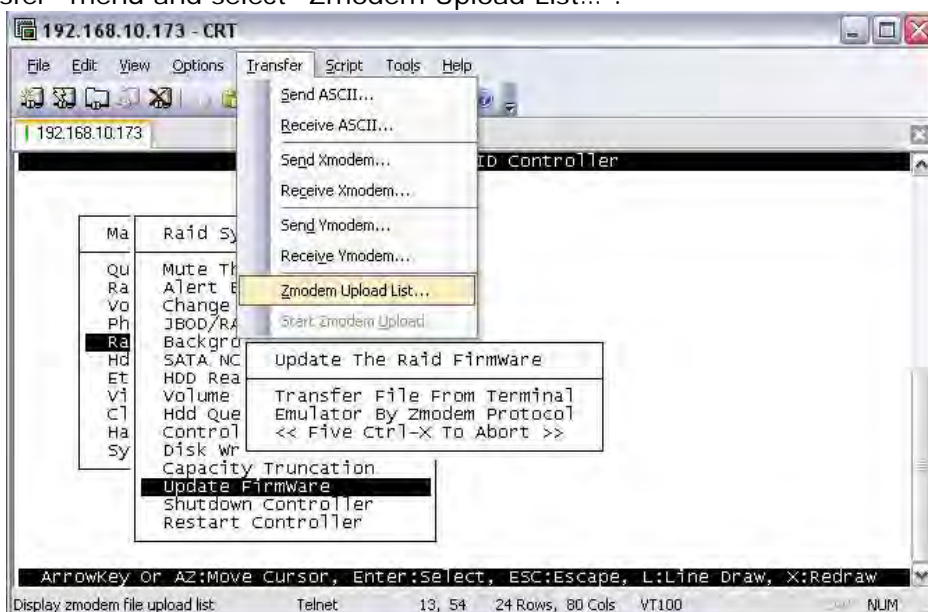

- Select the firmware BINARY file (xxxx-*vvv*-*yyyyyyyy*.bin) and click "Add". Then click "OK".



NOTE: The BOOT firmware file (xxxxBOOT-*vvv*-*yyyyyyyy*.bin) must be upgraded first. Then repeat the steps to upgrade the firmware file (xxxx-*vvv*-*yyyyyyyy*.bin).



- Select **Update Firmware**, and click "Transfer" and then "Start Zmodem Upload".



6. A message "Update The Firmware" will be displayed. Select "Yes".

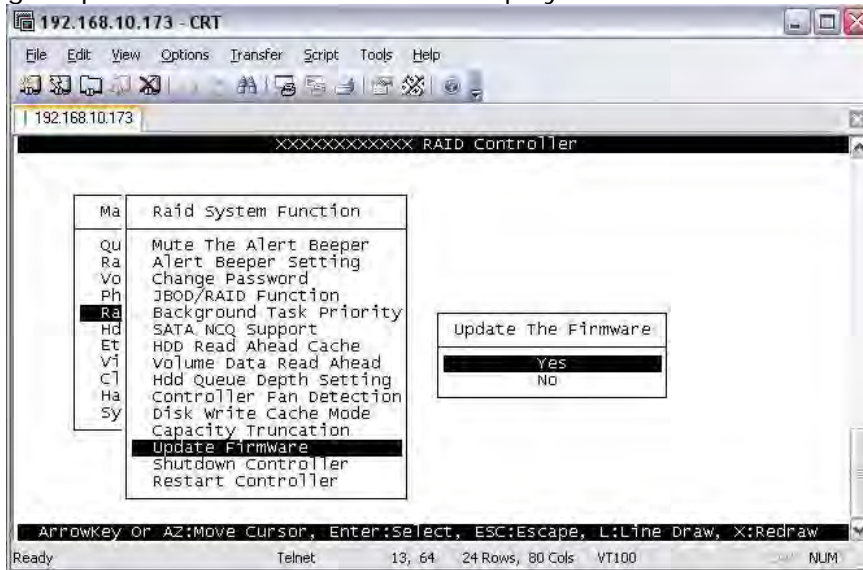

7. Select "Yes" again.

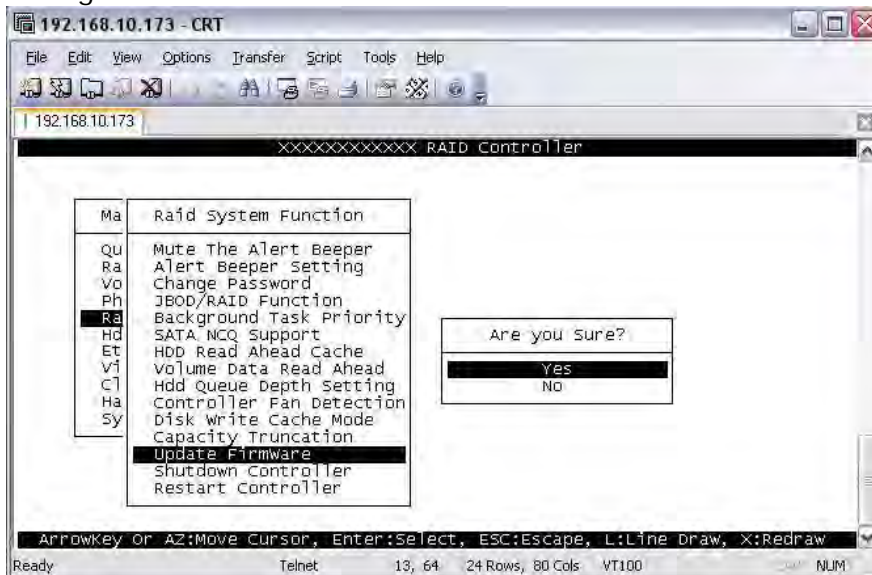

8. Message will show "Start Updating Firmware, Please Wait".

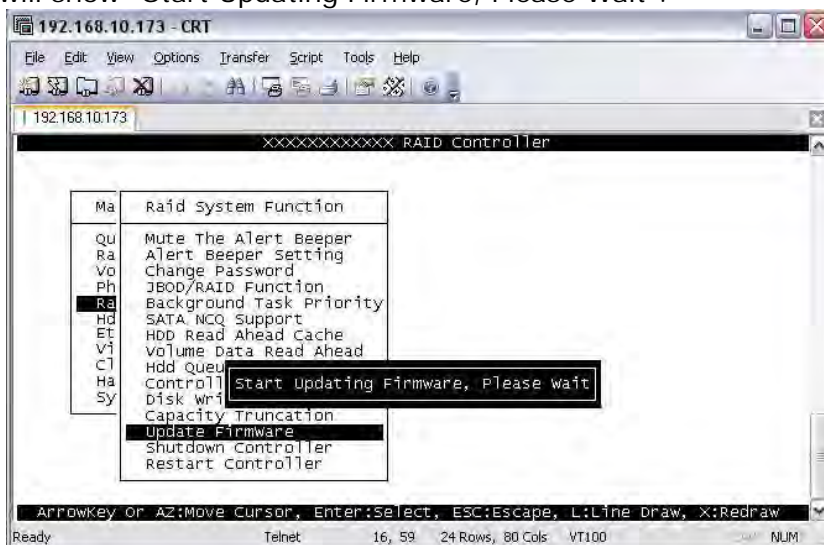

9. Message will show "Firmware has been updated successfully".

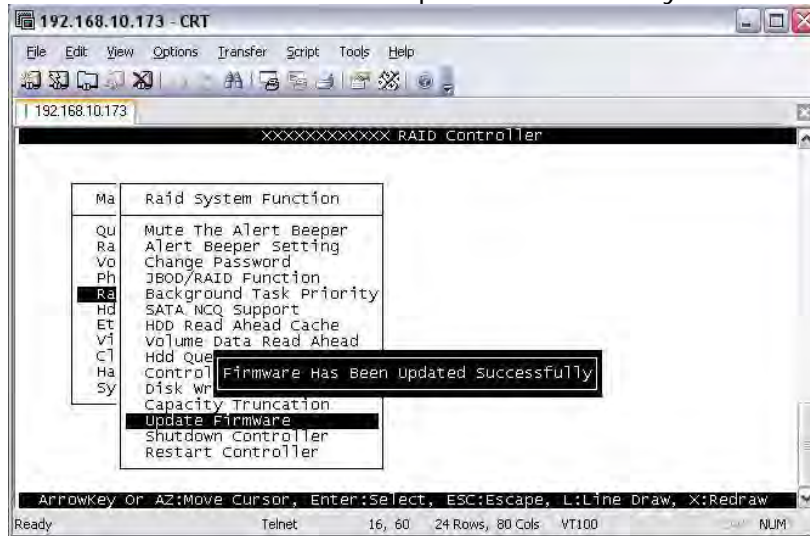

10. The RAID Controller must be restarted in order for the new firmware to take effect.

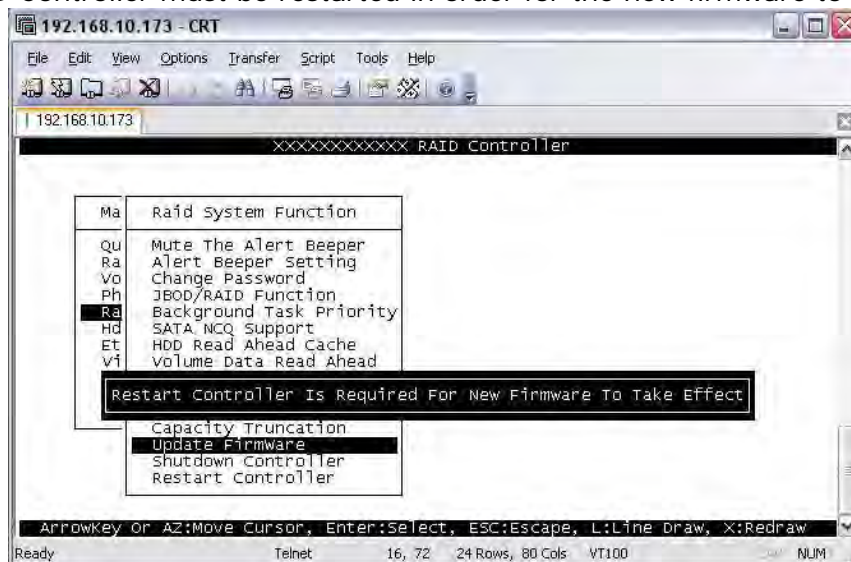

11. Select **Restart Controller** and then select "Yes".

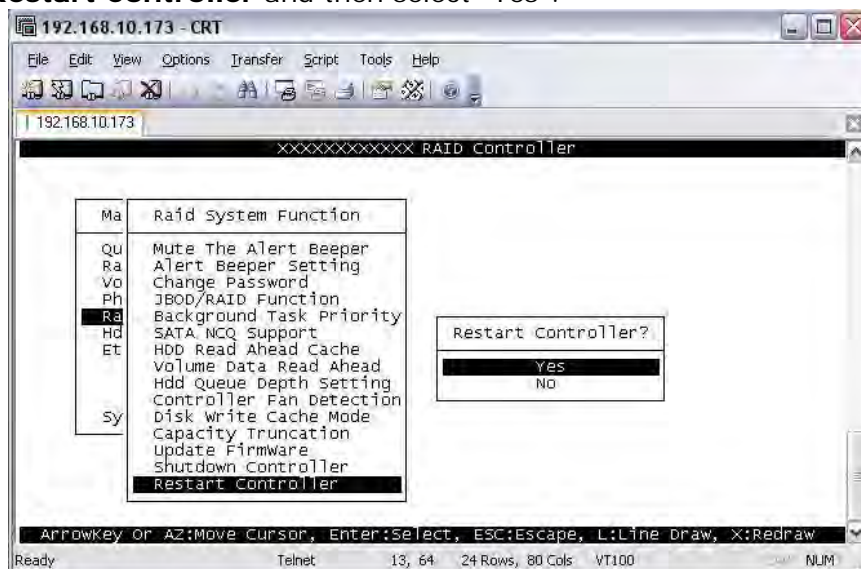

12. Select "Yes" again to confirm. The RAID controller will restart.

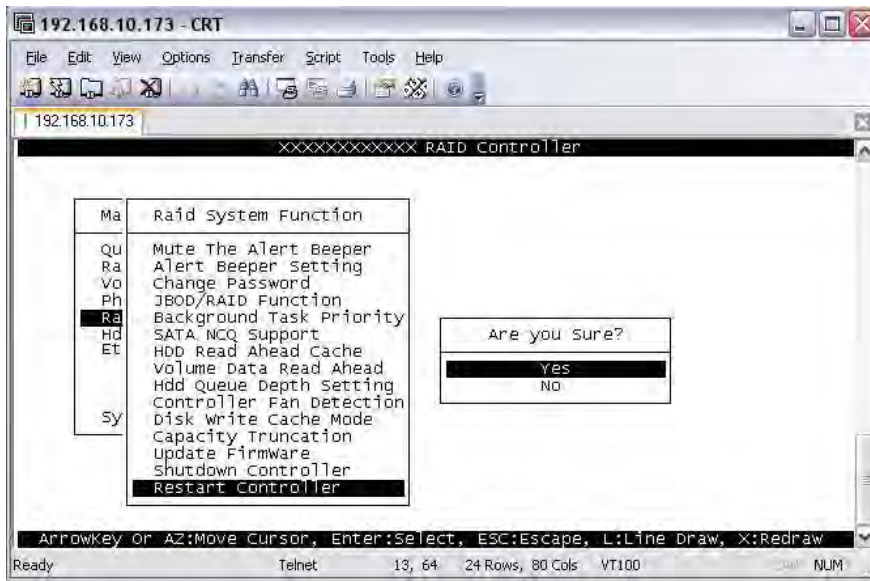

Upgrading Firmware Through Web Browser

Get the new version of firmware for your RAID Subsystem.



NOTE: When there is new boot ROM firmware that needs to be upgraded, upgrade first the boot ROM firmware. Then repeat the process (steps 1 to 3) to upgrade the firmware code after which a RAID controller restart will be necessary.

1. To upgrade the RAID Subsystem's firmware, click the **Upgrade Firmware** link under **System Controls** menu. The Upgrade The RAID System Firmware Or Boot Rom screen appears.
2. Click **Browse**. Look in the location where the firmware file was saved. Select the firmware file name "XXXXXXXXX.BIN" and click Open.
3. Select the **Confirm The Operation** option. Click the **Submit** button.

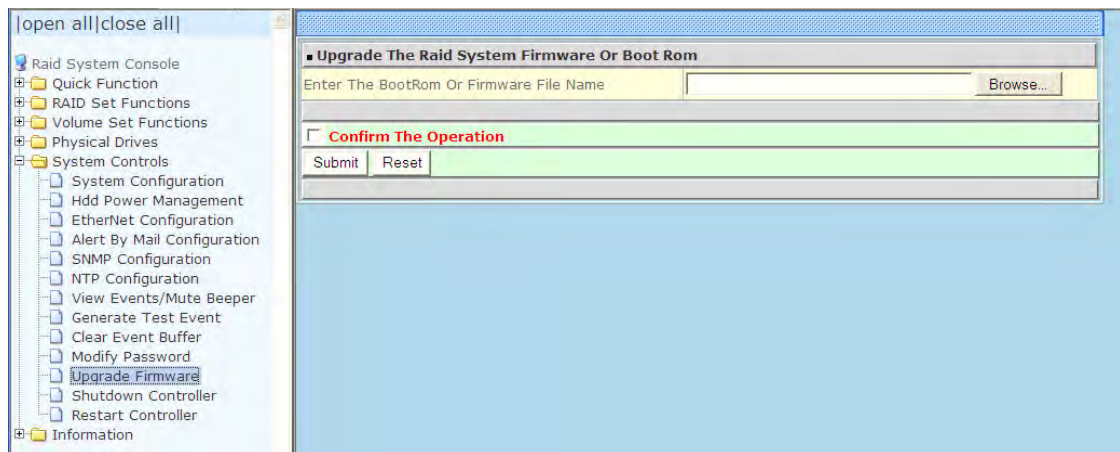

4. The Web Browser begins to download the firmware binary to the controller and start to update the flash ROM.
5. After the firmware upgrade is complete, a message will show "Firmware Has Been Updated Successfully". Restarting the RAID controller is required for the new firmware to take effect.

6.3 Replacing Subsystem Components



CAUTION: When replacing the components of the subsystem, make sure to handle the parts carefully. When handling ESD sensitive parts such as boards or PCBA, it is recommended to use anti-static hand gloves or wrist strap.

Make sure somebody is around to give help when servicing the subsystem.

Take note of the following when replacing the components of the subsystem.

Hot Swappable (Subsystem is online)	Need to Power Off (Subsystem should be offline)
Disk Drive Trays	Front Panel
Power Supply	Bottom Board
SAS Expander (single controller mode)	
Turbo Fan (Fan 06-1)	



IMPORTANT:

(1.) When the subsystem is online and a Power Supply fails, and the replacement Power Supply module is not yet available, don't remove or disconnect the failed Power Supply module. This is to maintain proper airflow within the enclosure, since the fans will still be working.

(2.) When the subsystem is online and a Controller module or SAS Expander module fails and the replacement is not yet available, in order to maintain proper airflow within the enclosure, the failed module can be disconnected just about an inch but not entirely removed from the slot. This is to maintain proper airflow within the enclosure.

(3.) When replacing a failed component online, it is not recommended to remove the failed component for a long period of time; proper air flow within the enclosure might fail causing high controller / disk drive temperature.

6.3.1 Replacing a Disk Drive



NOTE: When the subsystem is already in operational mode, it is not recommended to open the top cover for a long period of time; proper air flow within the enclosure might fail causing high disk drive temperature.

To replace a disk drive:

1. Loosen two screws on both sides of the top cover on the front panel side.



2. Use the Top Cover Key to unlock the key lock on the front panel side.

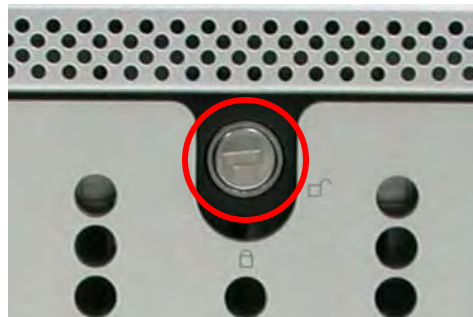

3. Hold the front part of the top cover and slide the top cover about half an inch towards the front side then pull upwards to remove it.



4. To remove the disk tray containing the disk drive to be replaced, unlock the disk tray lock using the key for disk tray lock. The lever handle will automatically open. If the lever handle does not automatically open, pull upwards the tip of the lever handle (part where the tray lock is located). Then pull upwards the lever handle of the disk tray.

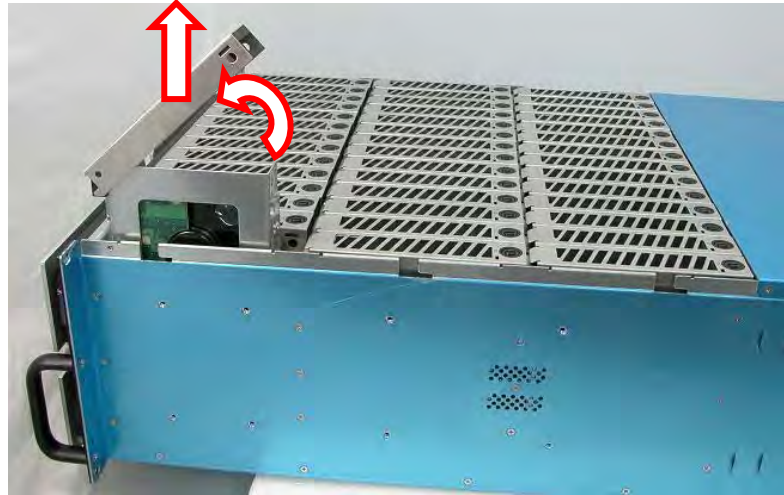

5. Remove the 4 screws on the bottom part of the disk tray.

For SAS Disk Drive or SATA Disk Drive:

- a. Remove the 4 screws as indicated in the picture.



- b. Remove the disk drive from the disk tray and place the new disk drive.
- c. To secure the disk drive in the disk tray, tighten the 4 screws that were removed before.



6. Insert the disk tray into the disk slot.



7. Then push down the latch part of disk tray as indicated in the picture below until it reached a full stop.



8. Close the lever handle then use the Key for Disk Tray Lock and turn the disk tray lock into "locked" position.



9. When all disks that need to be replaced have been replaced, put the top cover back and place it about half an inch away. Then push the top cover towards the rear.



10. Use the Top Cover Key to lock the key lock on the front panel side.

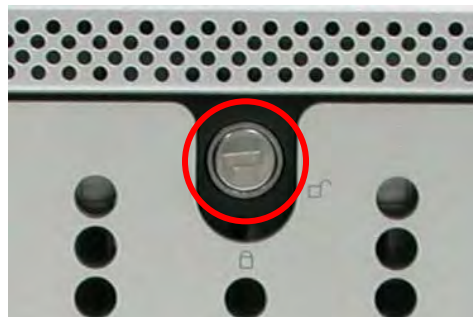

11. To secure the top cover, tighten two screws on both sides of the top cover on the front panel side.



6.3.2 Replacing the RAID Controller Module

To replace a RAID Controller Module:

1. Loosen the 2 thumbscrews of the RAID controller module.
2. Pull the handle outwards. The lock will disengage and the controller module will move out from the slot.
3. Pull out the controller module.
4. Remove the screws from the bottom part of the controller module.
5. Remove the controller PCBA from the case.
6. Remove the screws from the daughter board. Then remove the daughter board.
7. Remove the cache memory from the DIMM socket.
8. Connect the cache memory to the new controller PCBA.
9. Place the daughter board to the new controller PCBA and tighten the screws.
10. Place the new controller PCBA in the case. Then tighten the screws (at the bottom part) that were removed before.
11. Insert the controller module into the slot.
12. With the handle in open position, push the controller module handle until the lock is engaged.
13. Tighten the 2 thumbscrews on the controller module handle.

6.3.3 Replacing the Power Supply Fan Module

Before replacing a PSFM, turn off the PSFM switch and disconnect the power cable from the AC Power Input Socket.

To replace a Power Supply Fan Module:

1. Loosen the thumbscrews of the Power Supply Fan Module.



2. Pull the handle of the Power Supply Fan Module. The Power Supply Fan Module will move out from the slot.



3. Prepare the new Power Supply Fan Module.



4. Insert the replacement Power Supply Fan Module and push inwards. With the handle in open position, close the handle until the lock is engaged.

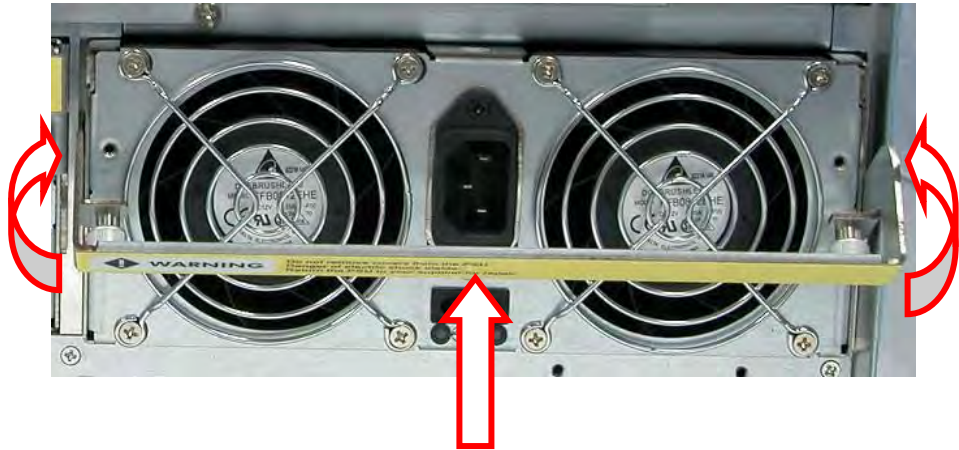

5. Tighten the 2 thumbscrews of the PSFM.



6.3.4 Replacing the Turbo Fan (Fan 06-1)

To replace the Turbo Fan Module:

1. Loosen the 2 screws of the Turbo Fan Module.

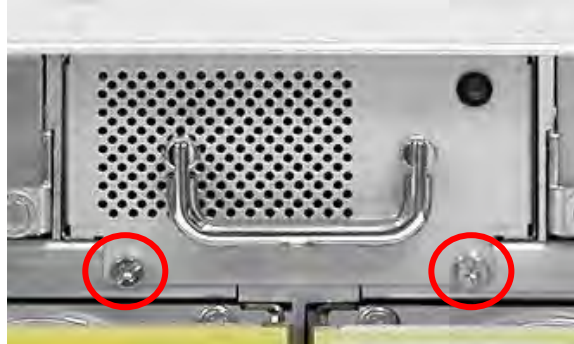

2. Pull the handle to remove the Turbo Fan Module from the slot.

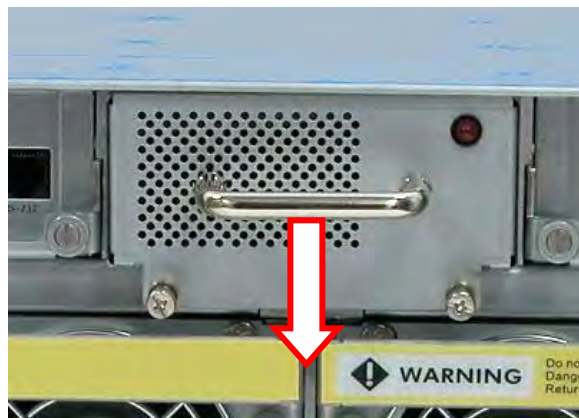

3. Insert the replacement Turbo Fan Module.



NOTE: If only the fan board will be replaced, disconnect first the fan cables, loosen the screws on the fan board, and replace the fan board.

4. Push the Turbo Fan Module until it is fully inserted.

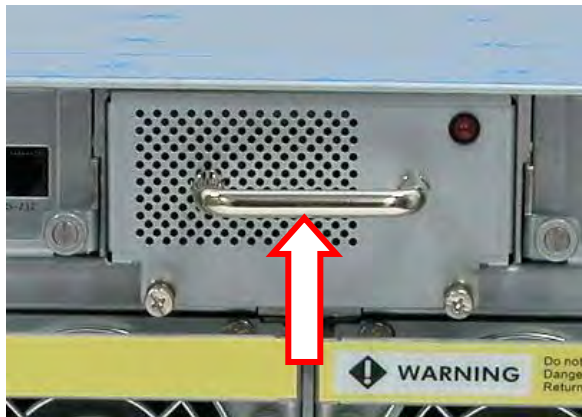

5. Tighten the 2 screws of the Turbo Fan Module.

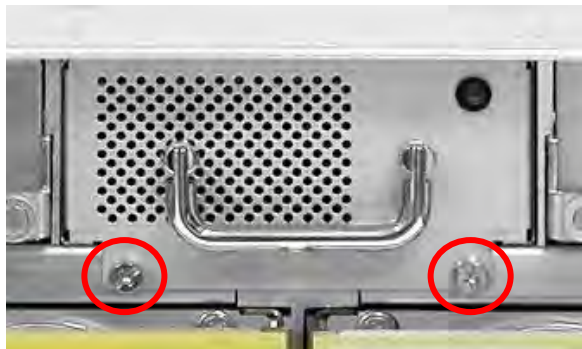

6.3.5 Replacing the Expander Module



CAUTION: Be careful when inserting the Expander Module. Carefully insert the module and make sure that the connector pins are not bent when the module is inserted.

To replace Expander Module:

1. Loosen the thumbscrew of the Expander Module.



2. Pull the thumbscrew just a little.

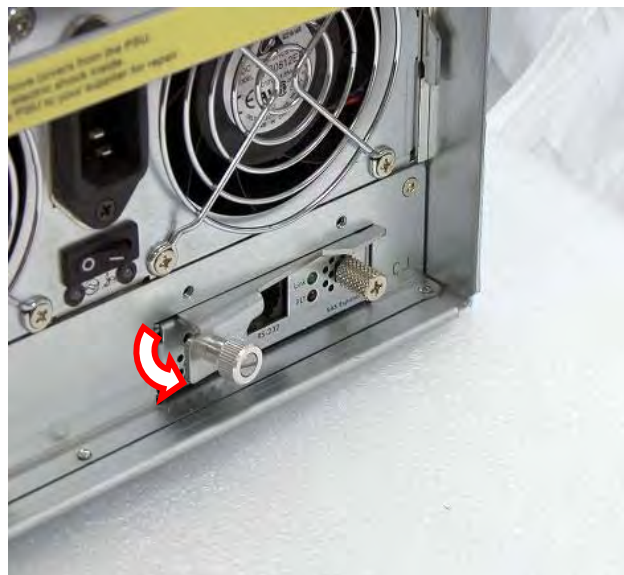

3. Hold the rear part of the thumbscrew handle with your thumb and your forefinger (index finger) on the other screw. Carefully move your thumb outwards to disengage the lock.

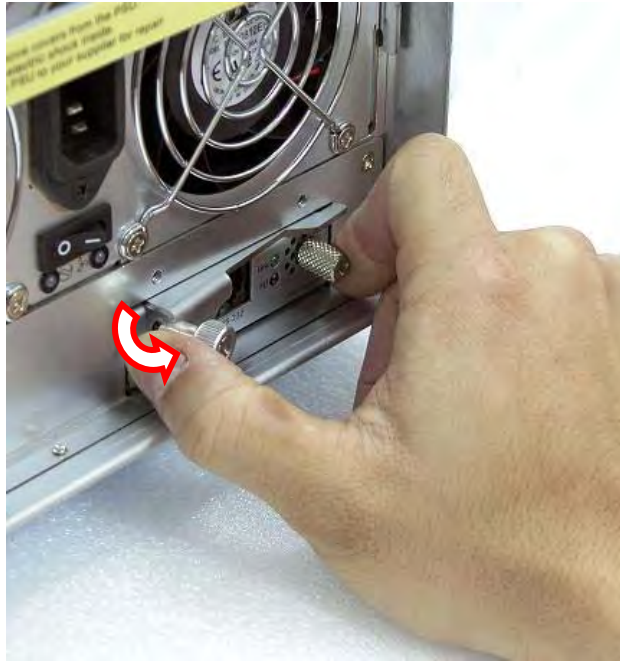

4. The lock will totally disengage and the expander module will move out from the slot.



5. Carefully pull out the handle to remove the expander module.

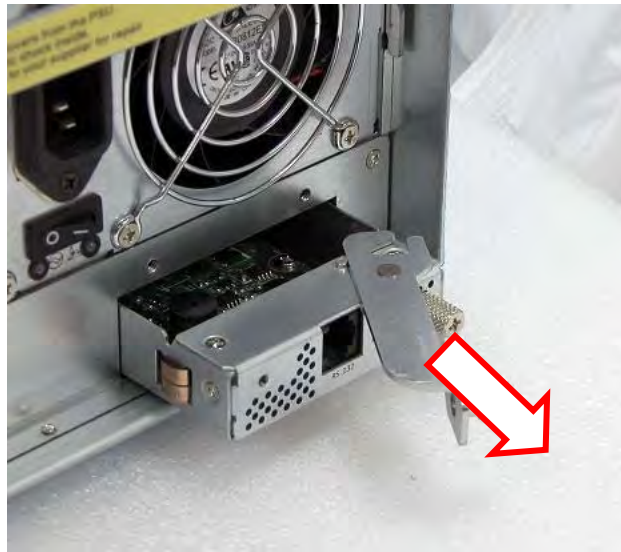

6. Remove the 2 screws from the heat sink. Remove the 6 screws from the Expander PCBA.



7. Place the new Expander PCBA and tighten the screws that were removed before.

8. Insert the Expander module in its slot.

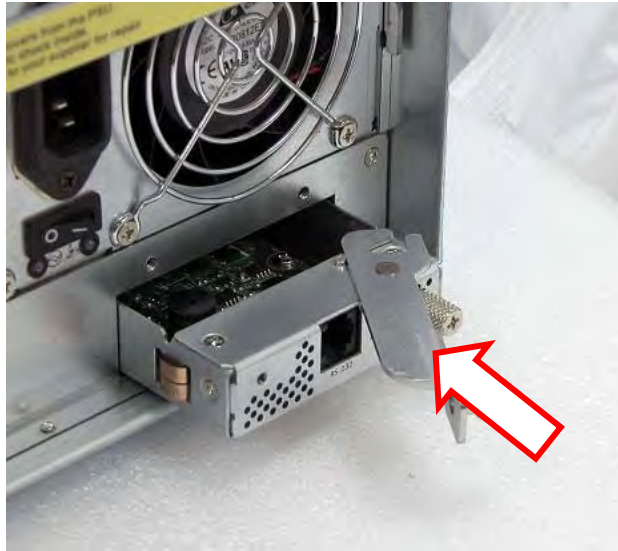

9. Make sure the lever lock is in open position. Carefully close the handle.



10. Carefully push the thumbscrew handle until the lock is engaged.

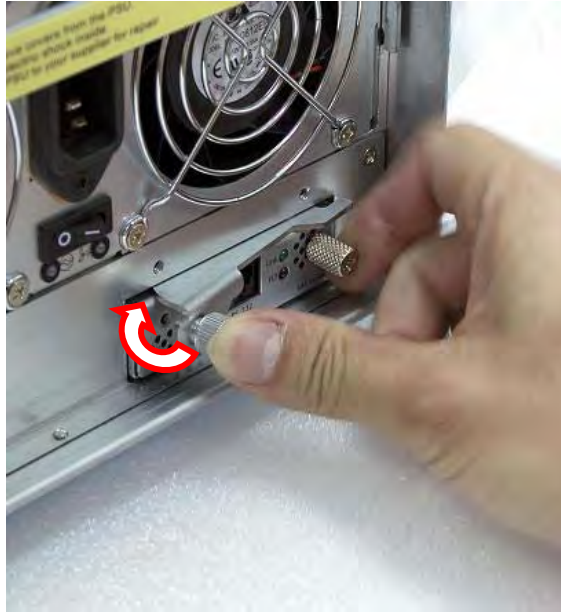

11. Make sure the thumbscrew handle is totally connected to the expander module panel. Tighten the thumbscrew.



To replace the Front Panel:

1. Loosen two screws on both sides of the top cover on the front panel side.



2. Use the Top Cover Key to unlock the key lock on the front panel side.

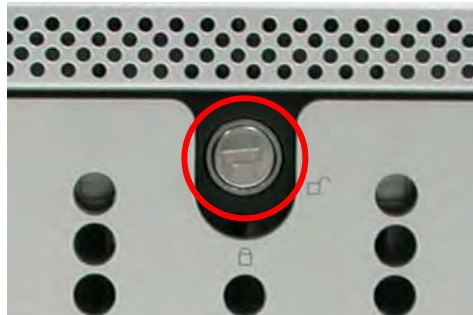

3. Hold the front part of the top cover and slide the top cover about half an inch towards the front side then pull upwards to remove it.



4. Loosen the 2 screws on both sides of the front panel.



5. Hold the front panel on both sides and carefully detach the front panel from the enclosure. Note that the main switch cable is connected to the front panel. Disconnect the cable.

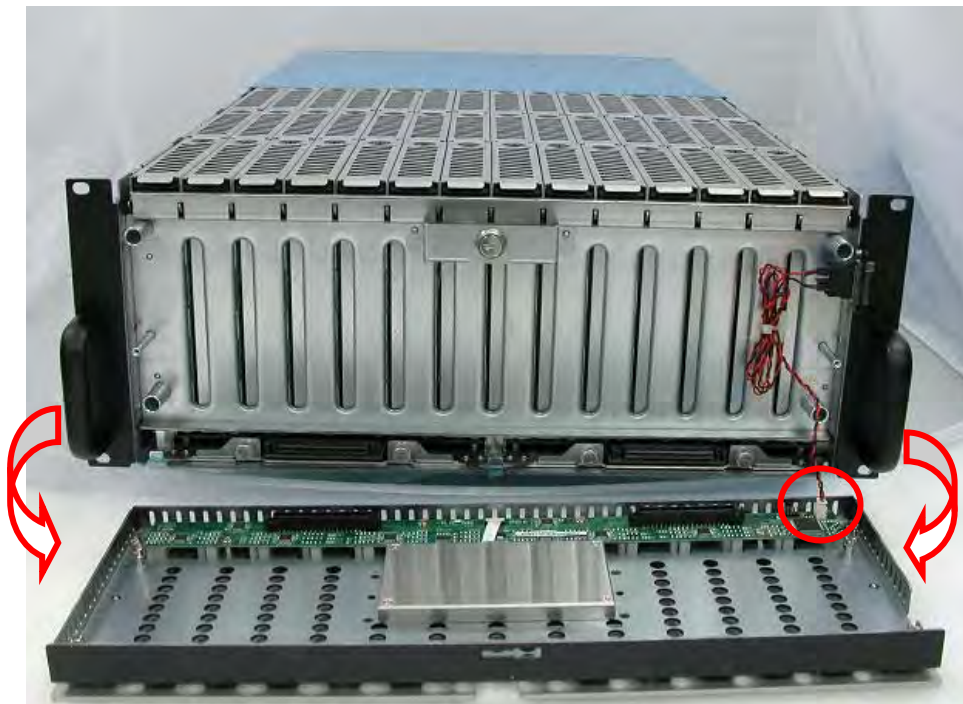

6. Replace the front panel.



7. Reconnect the cable to the front panel.

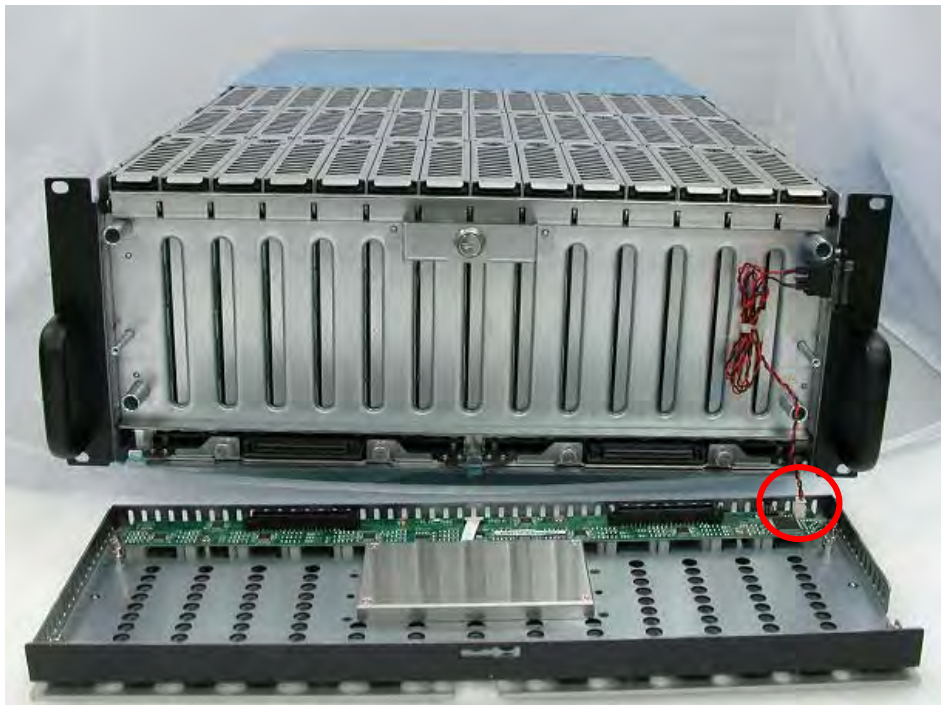

8. Hold the front panel and carefully attach to the enclosure. Note that there are 4 contact points which the front panel must connect to.

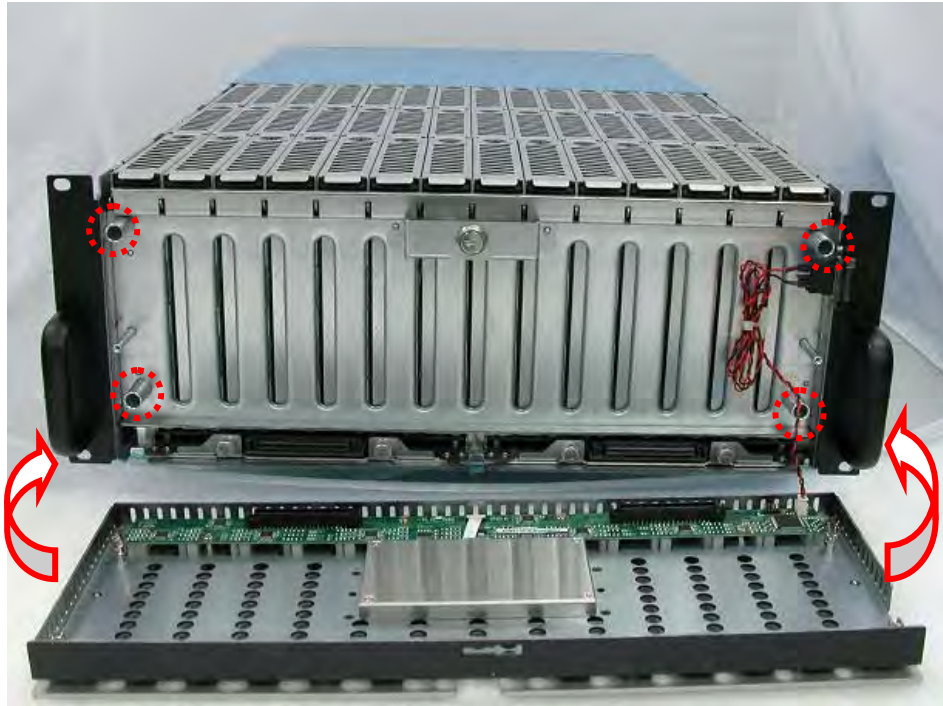

9. Tighten the 2 screws on the front panel side.



10. Put the top cover back and place it about half an inch away. Then push the top cover towards the rear.



11. Use the Top Cover Key to lock the key lock on the front panel side.

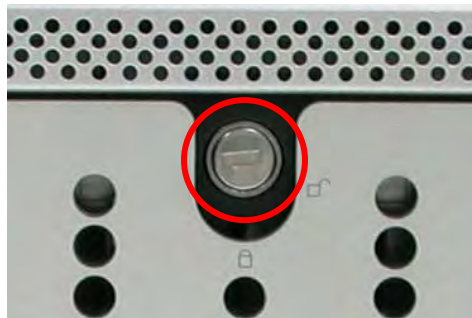

12. To secure the top cover, tighten two screws on both sides of the top cover on the front panel side.



6.3.7 Replacing the Bottom Board

The subsystem has 2 bottom boards. One or both bottom boards can be replaced, if necessary.

To replace a Bottom Board:

1. Loosen two screws on both sides of the top cover on the front panel side.



2. Use the Top Cover Key to unlock the key lock on the front panel side.

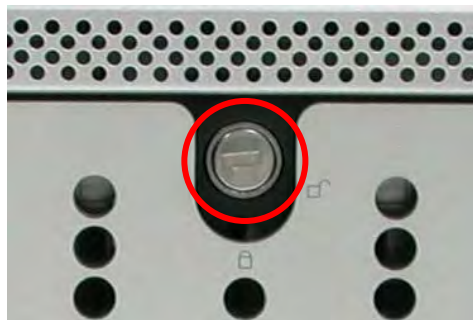

3. Hold the front part of the top cover and slide the top cover about half an inch towards the front side then pull upwards to remove it.



4. Loosen the 2 screws on both sides of the front panel.



5. Hold the front panel on both sides and carefully detach the front panel from the enclosure. Note that the main switch cable is connected to the front panel. Disconnect the cable.

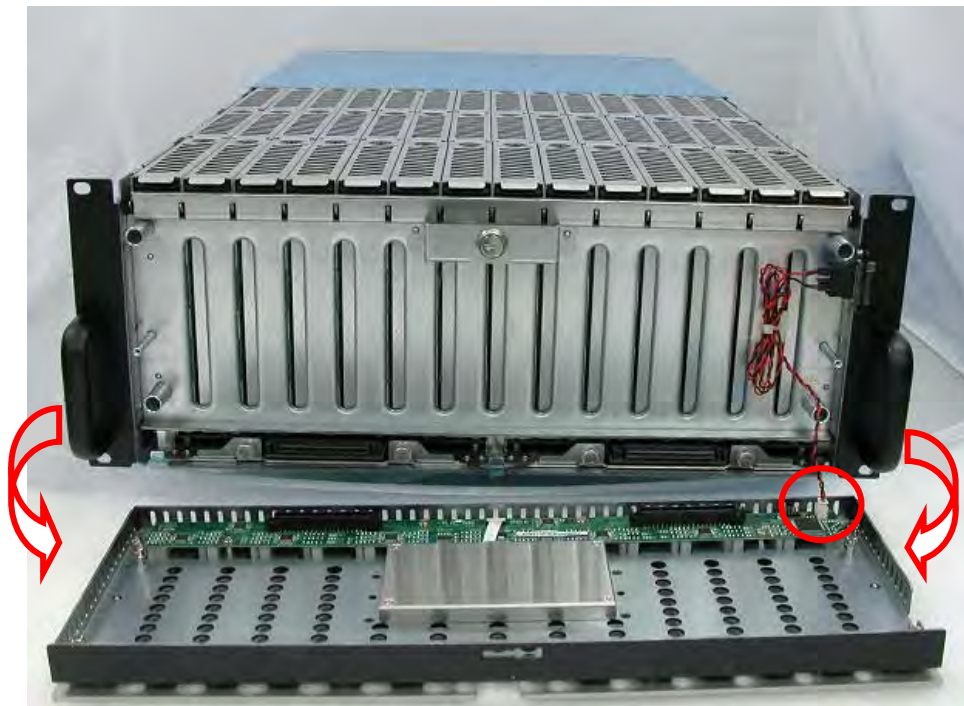

- Place the front panel in a safe place.



- If the right bottom board will be replaced, unlock and remove disk trays 1 to 21 and hung the trays in the slots. If the left bottom board will be replaced, unlock and remove disk trays 22 to 42 and hung the trays in the slots.

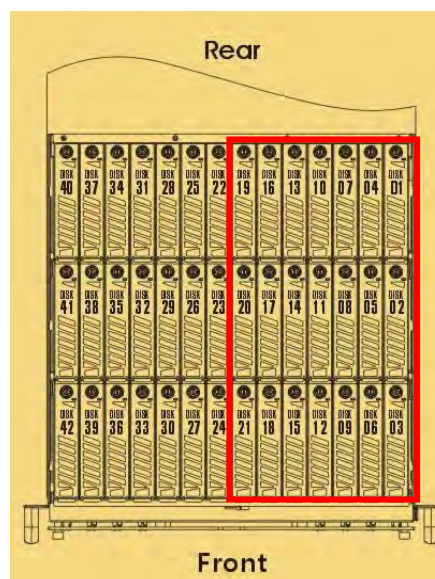

- Loosen 2 screws on the bottom part of the subsystem, on the subsystem side of the bottom board to be removed. (To have access to the 2 screws, the subsystem need to be moved a few inches forward.)

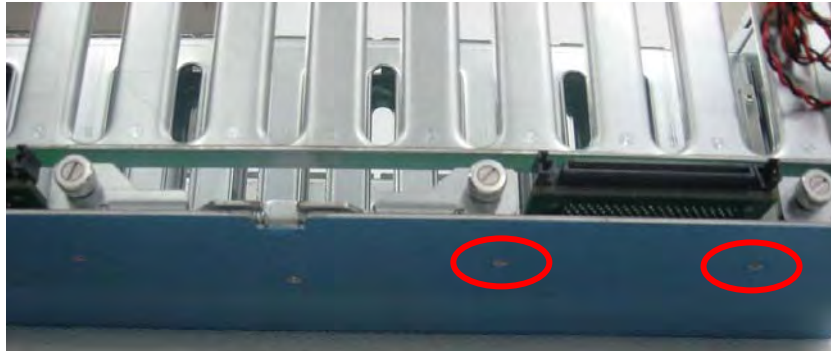

- Loosen the 2 thumbscrews of the bottom board then pull the 2 thumbscrews. The bottom board will detach from the enclosure. Pull the bottom board outwards.

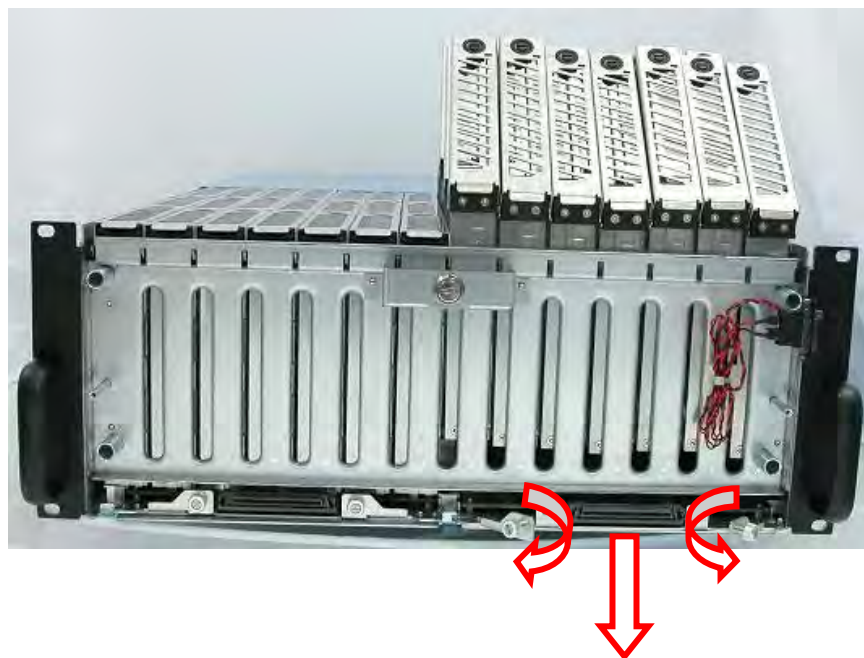

- Replace the bottom board. If necessary, remove the screws from the bottom board and place the new bottom board then tighten back the screws.



11. Before reinserting the bottom board, the expander module(s) need to be removed. This is a precautionary step to prevent the connector pins of the expander module(s) from possibly being bent when the bottom board is inserted. Refer to Section on Replacing the Expander Module for steps on how to remove or reinsert the expander module.

Controller Mode:	Bottom Board that was/were Replaced:	Expander Module(s) to be Removed:
Single Controller	Left	1-2
Single Controller	Right	1-1
Single Controller	Left and Right	1-1 and 1-2



Left Bottom Board

Right Bottom Board

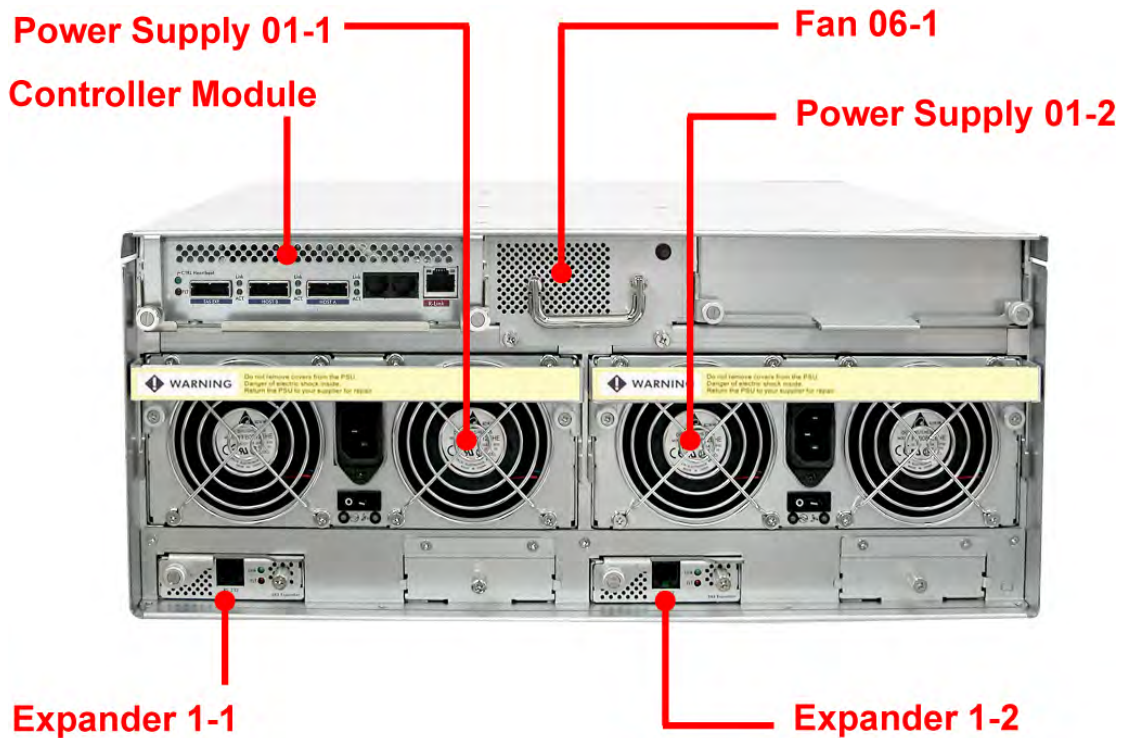

Power Supply 01-1

Fan 06-1

Controller Module

Power Supply 01-2

Expander 1-1

Expander 1-2

12. Insert the bottom board into the bottom board slot. Slide the bottom board inwards. Make sure the 2 thumbscrews are in open position. Push the 2 thumbscrews until the bottom board is engaged in the enclosure.

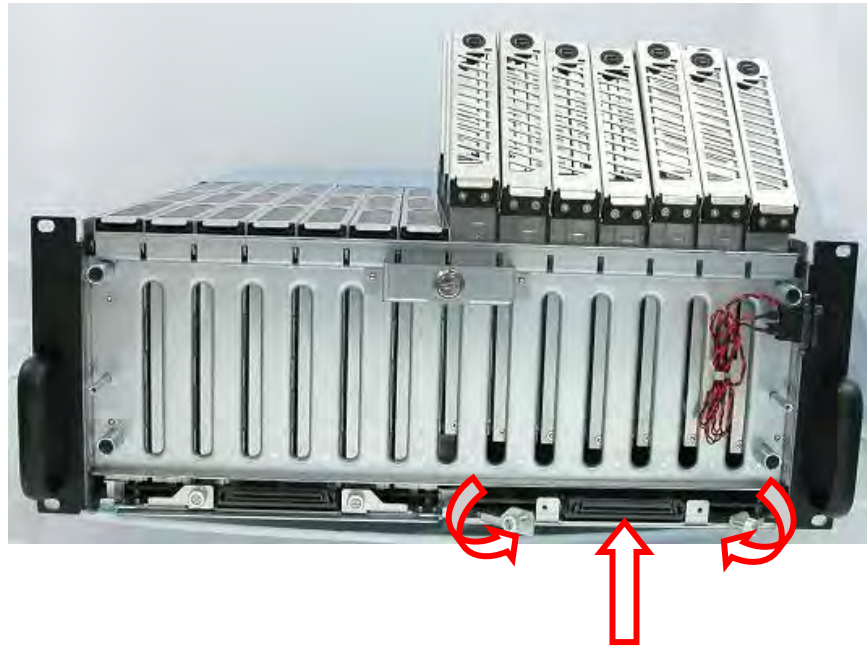

13. Tighten the 2 thumbscrews of the bottom board.
14. Tighten the 2 screws on the bottom part of the subsystem, on the subsystem side of the bottom board that was replaced.
15. Reinsert the Expander Module(s) that was/were removed in Step 11.
16. Insert all the disk trays that were hung and lock them.
17. Reconnect the cable to the front panel.

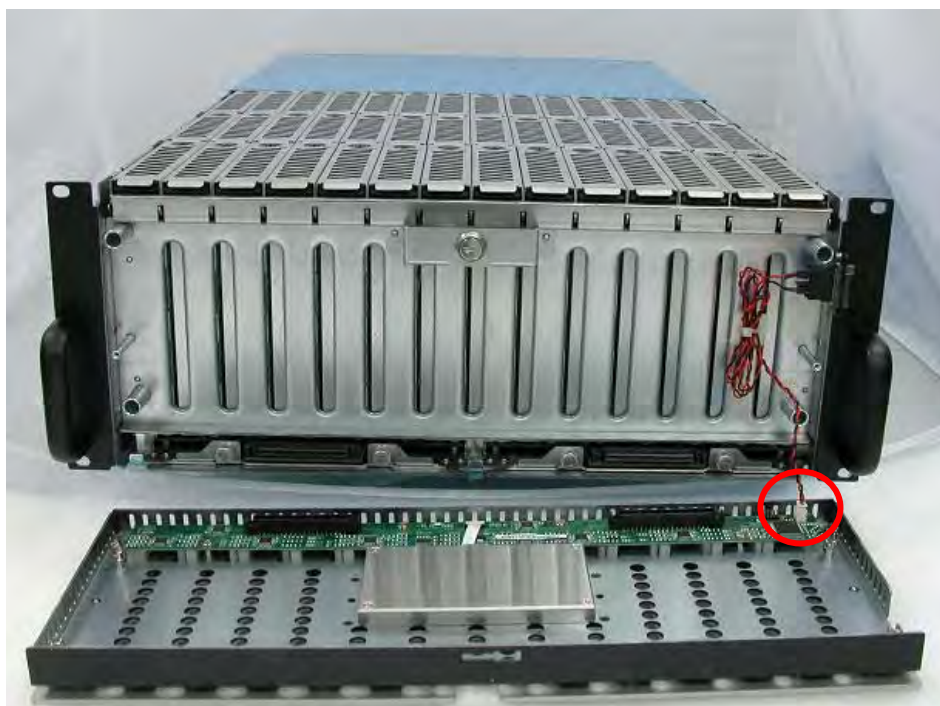

18. Hold the front panel and carefully attach to the enclosure. Note that there are 4 contact points which the front panel must connect to.

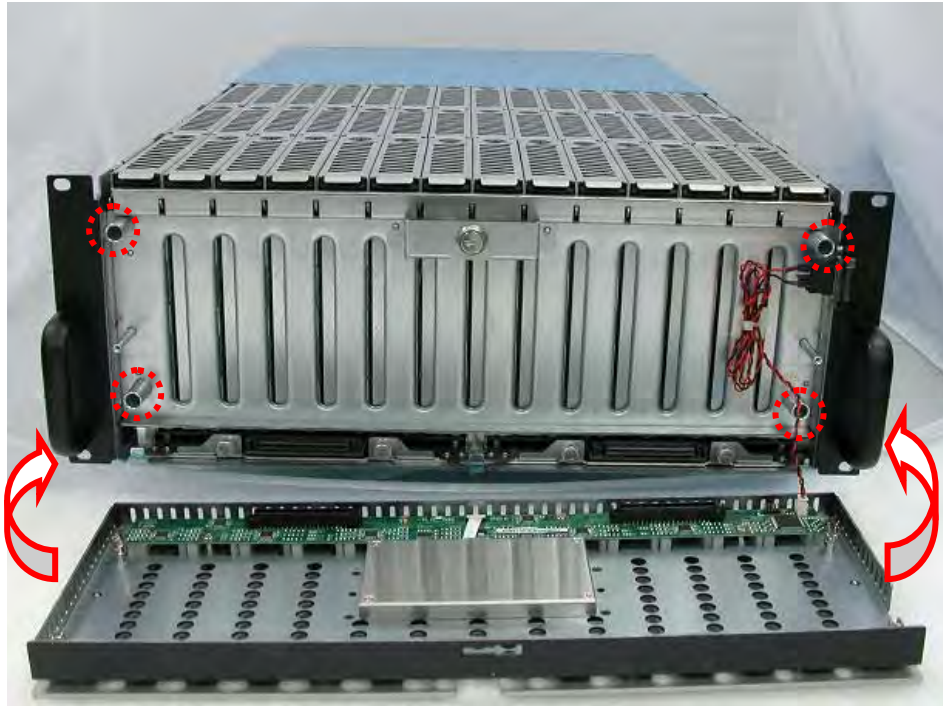

19. Tighten the 2 screws on the front panel side.



20. Put the top cover back and place it about half an inch away. Then push the top cover towards the rear.



21. Use the Top Cover Key to lock the key lock on the front panel side.

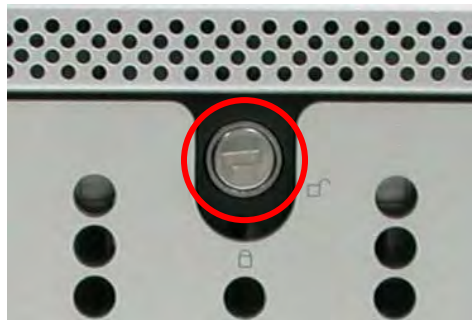

22. To secure the top cover, tighten two screws on both sides of the top cover on the front panel side.



Appendix 1 Disk Power Off/On Function in Web GUI



NOTE: This document is intended to help Support Engineers to remotely verify disk problem in the RAID Subsystem.

In order to use the Disk Power Cycle (Off/On) Function in Web GUI, the RAID Subsystem must use Firmware version 1.48.

1. When Disk Fails, How to Use Disk Power Function Command in Web GUI; Hot Spare is Not Configured



NOTE: When a disk fails and the Volume Set use RAID Level with redundancy, such as RAID Level 5, the Volume Set state will become Degraded.

1. Check which Disk has failed. In this example, **Disk** in **Enclosure#1 Slot#1** has failed. The disk failure event can also be verified in the System Event Information (event log) when you use "View Events/Mute Beeper" under System Controls.

The screenshot displays the RAID Subsystem Web GUI. The left sidebar shows a tree view with 'RAID Set Hierarchy' selected. The main content area is divided into two sections:

RAID Set Hierarchy

RAID Set	Devices	Volume Set(Ch/Lun)	Volume State	Capacity
Raid Set # 000	Failed	Volume---VOL#000(0&1/0)	Degraded	9000.0GB
	E#1Slot#2	Volume---VOL#001(0&1/1)	Initializing(23.8%)	9000.0GB
	E#1Slot#4			
	E#1Slot#6			
	E#1Slot#7			
	E#1Slot#9			
	E#1Slot#12			
	E#1Slot#13			
	E#1Slot#14			
	E#1Slot#15			
	E#1Slot#16			

Enclosure#1 : SAS RAID Subsystem V1.0

Device	Usage	Capacity	Model
Slot#1 (0:A)	Failed	2000.4GB	WDC WD2002FYPS-01U1B0
Slot#2 (0:9)	Raid Set # 000	2000.4GB	WDC WD2002FYPS-01U1B0
Slot#3	N.A.	N.A.	N.A.
Slot#4	N.A.	N.A.	N.A.



NOTE: The Disk used in this example is from Enclosure#1 Slot#1. Make sure to verify which **Enclosure#** and **Slot#** the failed disk is located.

2. **To power off the Disk in Slot#1 of Enclosure#1**, select “Rescue RAID Set” under RAID Set Functions. In the Enter The Keyword box, type “**PowerOffDisk**”, press space bar, and then type “**Enclosure#1 Slot#1**”. The contents of “Enter The Keyword” box will become “**PowerOffDisk Enclosure#1 Slot#1**”. Tick “Confirm The Operation” and click “Submit”.

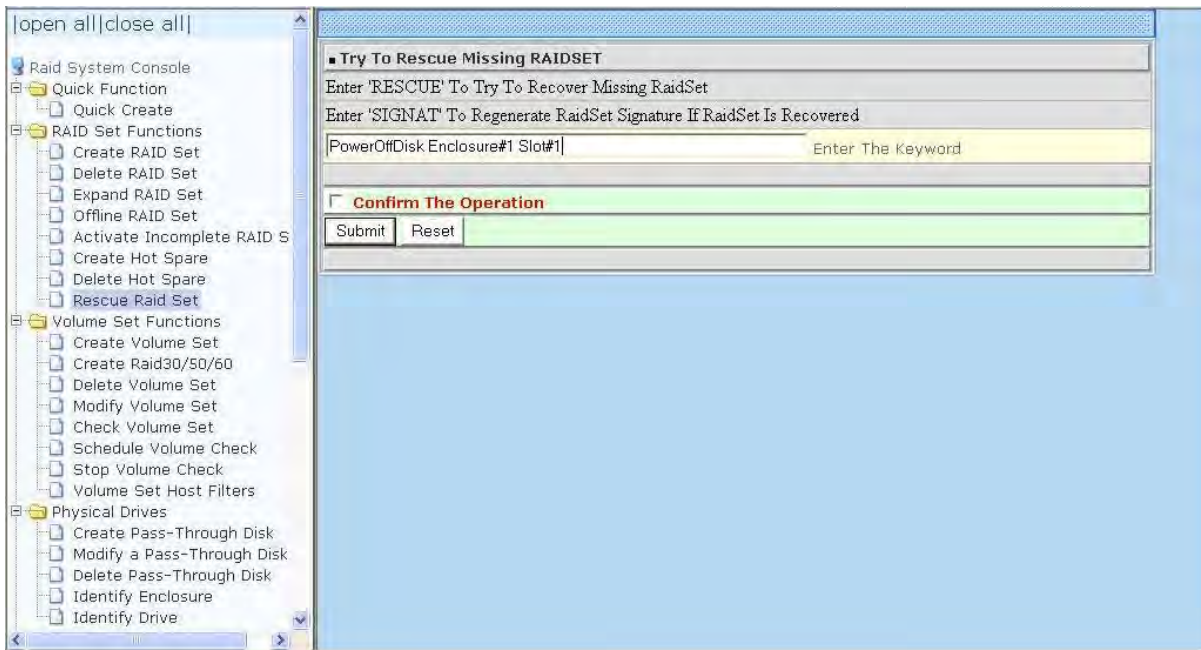

NOTE: Sometimes the “PowerOffDisk” command will need to wait for several seconds before command execution is completed (web GUI is updated), specially when the RAID Subsystem is active or busy.



NOTE: If you try to power off a Disk, for example Disk in Slot#3 of Enclosure#1, but the Disk is not failed the Disk will not be powered off. The screen will show “Device Not In Failed State”.



- The Disk Power will be turned off. In Device List of Enclosure#1, Disk in Slot#1 will no longer appear.

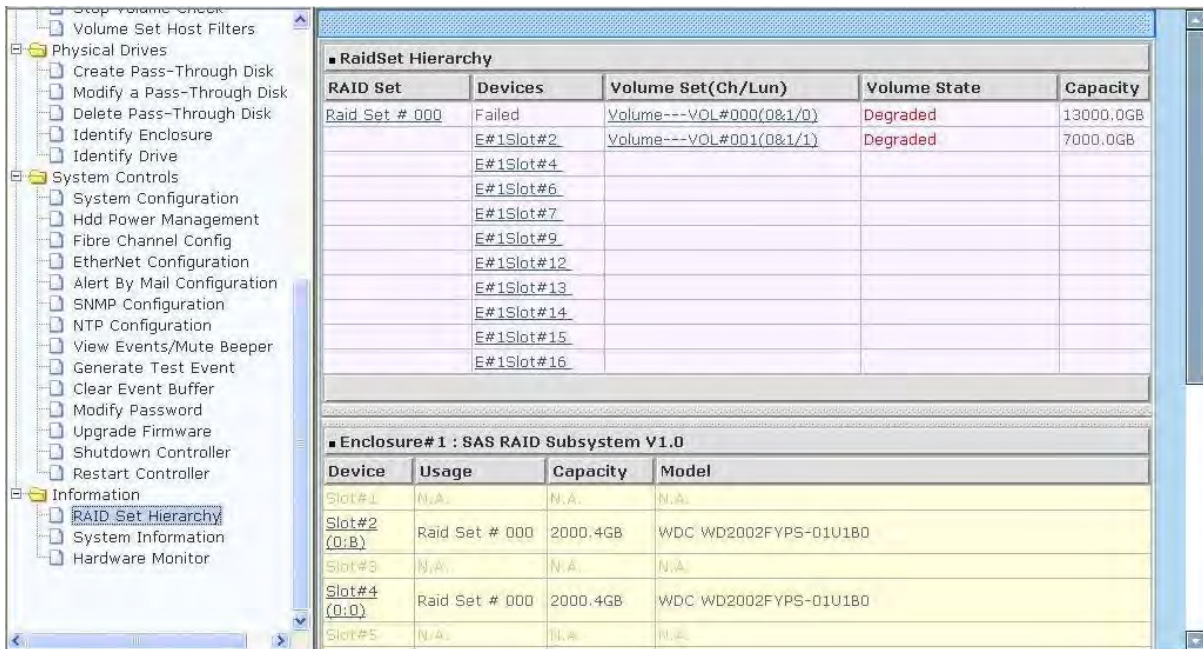
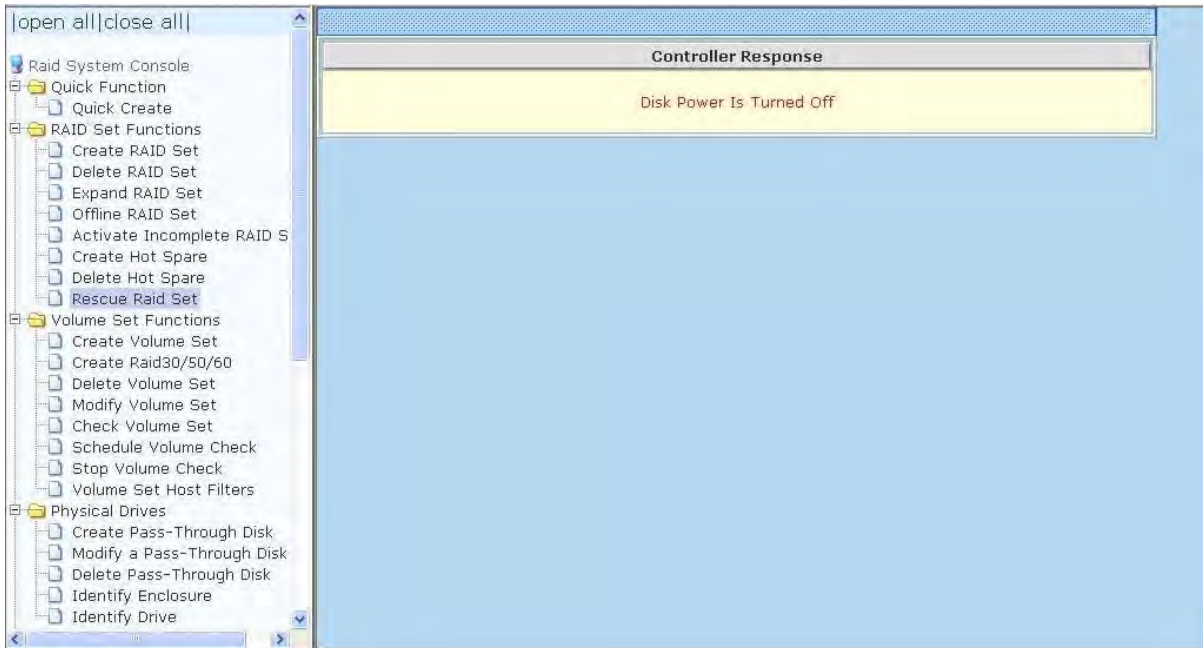

4. **To verify if Disk is really failed or still usable, you can try to power on the Disk. To power on Disk in Slot#1 of Enclosure#1, select "Rescue RAID Set".** In the "Enter The Keyword" box, type "**PowerOnDisk**", press space bar, and then type "**Enclosure#1 Slot#1**". The contents of "Enter The Keyword" box will become "**PowerOnDisk Enclosure#1 Slot#1**". Tick "Confirm The Operation" and click "Submit".

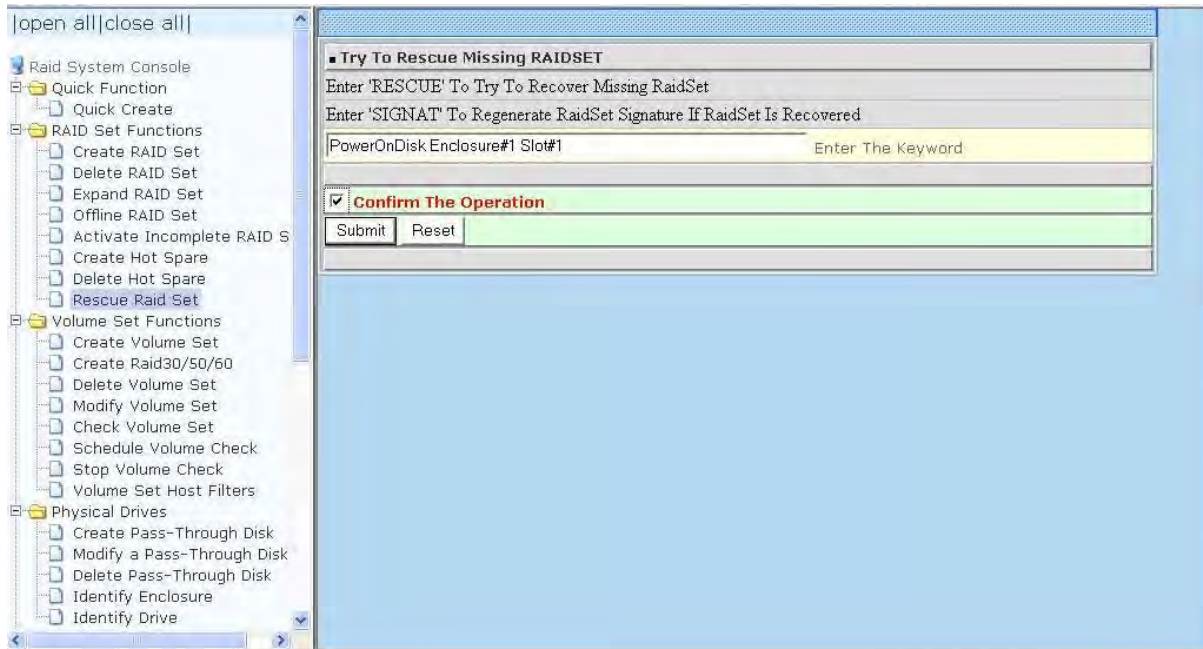

NOTE: Sometimes the "PowerOnDisk" command will need to wait for several seconds before command execution is completed (web GUI is updated), specially when the RAID Subsystem is active or busy.

5. If the Disk in Enclosure#1 Slot#1 is **still good**, the Disk in Slot#1 of Enclosure#1 will be turned on. The RAID Set and Volume Set will be rebuilt automatically. The Volume Set state will show "Rebuilding".

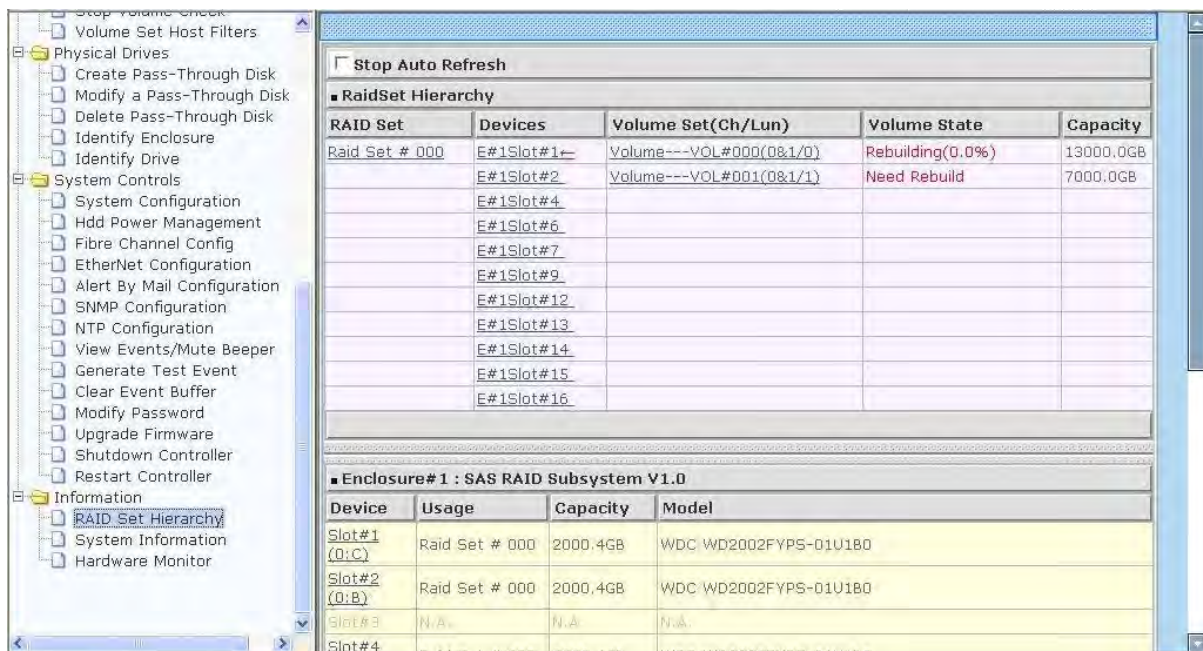
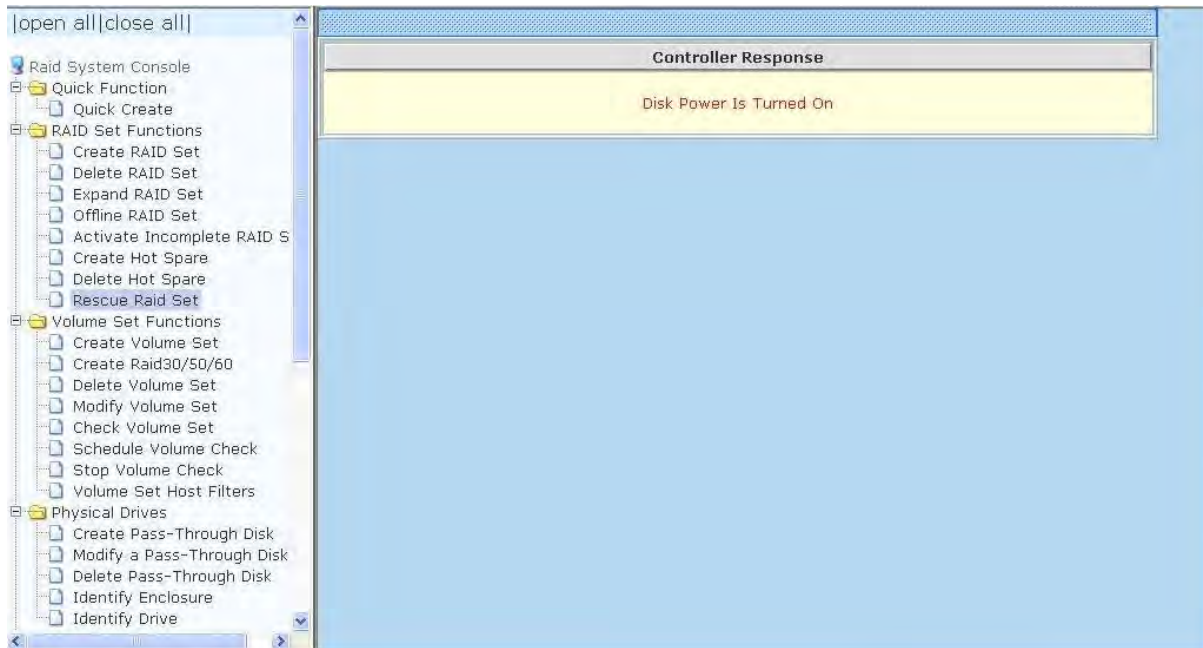

IMPORTANT: If the disk is really failed and cannot power on, replace the failed disk with a new one.

If the failed disk is still good, observe this particular disk. If this disk fails again, replace it with a new one.

Use the disk manufacturer's utility/disk tool to verify the health status of the failed disk.

3. In RAID Set Hierarchy, the Volume Set state will be shown as “Rebuilding”. Note that Disk in Slot#1 is shown as “Failed”.

The screenshot displays the RAID System Console interface. On the left is a tree view with categories: RAID Set Functions, Volume Set Functions, and Physical Drives. The main area shows the RAID Set Hierarchy table and the Enclosure#1 details table.

RAID Set	Devices	Volume Set(Ch/Lun)	Volume State	Capacity
Raid_Set # 000	E#1Slot#2 E#1Slot#4 E#1Slot#6 E#1Slot#7 E#1Slot#9 E#1Slot#12 E#1Slot#13 E#1Slot#14 E#1Slot#15 E#1Slot#16	Volume---VOL#000(0&1/0)	Rebuilding(0.0%)	18000.0GB

Enclosure#1 : SAS RAID Subsystem V1.0			
Device	Usage	Capacity	Model
Slot#1 (0:C)	Failed	2000.4GB	WDC WD2002FYPS-01U1B0
Slot#2 (0:B)	Raid Set # 000	2000.4GB	WDC WD2002FYPS-01U1B0
Slot#3	N.A.	N.A.	N.A.
Slot#4 (0:2)	Raid Set # 000	2000.4GB	WDC WD2002FYPS-01U1B0

4. To power off the Disk in Slot#1 of Enclosure#1, select “Rescue RAID Set” under RAID Set Functions. In the Enter The Keyword box, type “PowerOffDisk”, press space bar, and then type “Enclosure#1 Slot#1”. The contents of “Enter The Keyword” box will become “PowerOffDisk Enclosure#1 Slot#1”. Tick “Confirm The Operation” and click “Submit”.

The screenshot shows the RAID System Console with the 'Rescue RAID Set' option selected in the left-hand menu. The main window displays the 'Try To Rescue Missing RAIDSET' dialog box.

Enter 'RESCUE' To Try To Recover Missing RaidSet
 Enter 'SIGNAT' To Regenerate RaidSet Signature If RaidSet Is Recovered

PowerOffDisk Enclosure#1 Slot#1 Enter The Keyword

Confirm The Operation

Submit Reset



NOTE: Sometimes the “PowerOffDisk” command will need to wait for several seconds before command execution is completed (web GUI is updated), specially when the RAID Subsystem is active or busy.



NOTE: If you try to power off a Disk, for example Disk in Slot#3 of Enclosure#1, but the Disk is not failed the Disk will not be powered off. The screen will show “Device Not In Failed State”.



5. The Disk Power will be turned off.

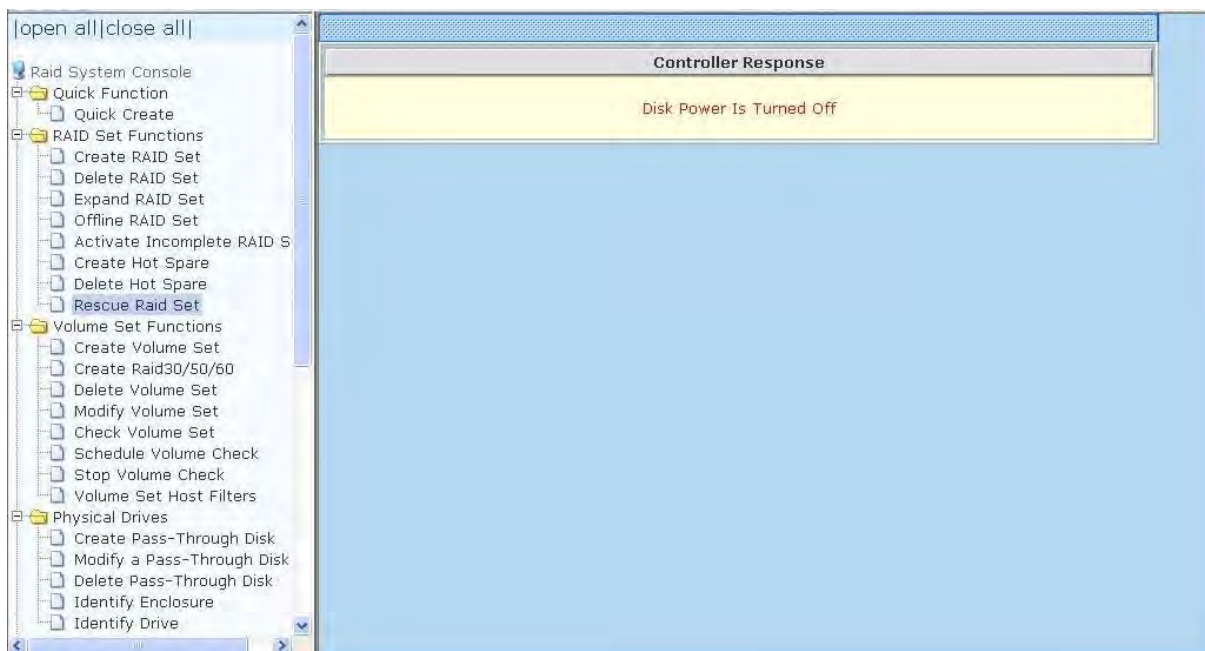

6. The System Event Information will show "Device Removed" for Device Enc#1 Slot#1.



7. In Device List of Enclosure#1, Disk in Slot#1 will no longer appear.

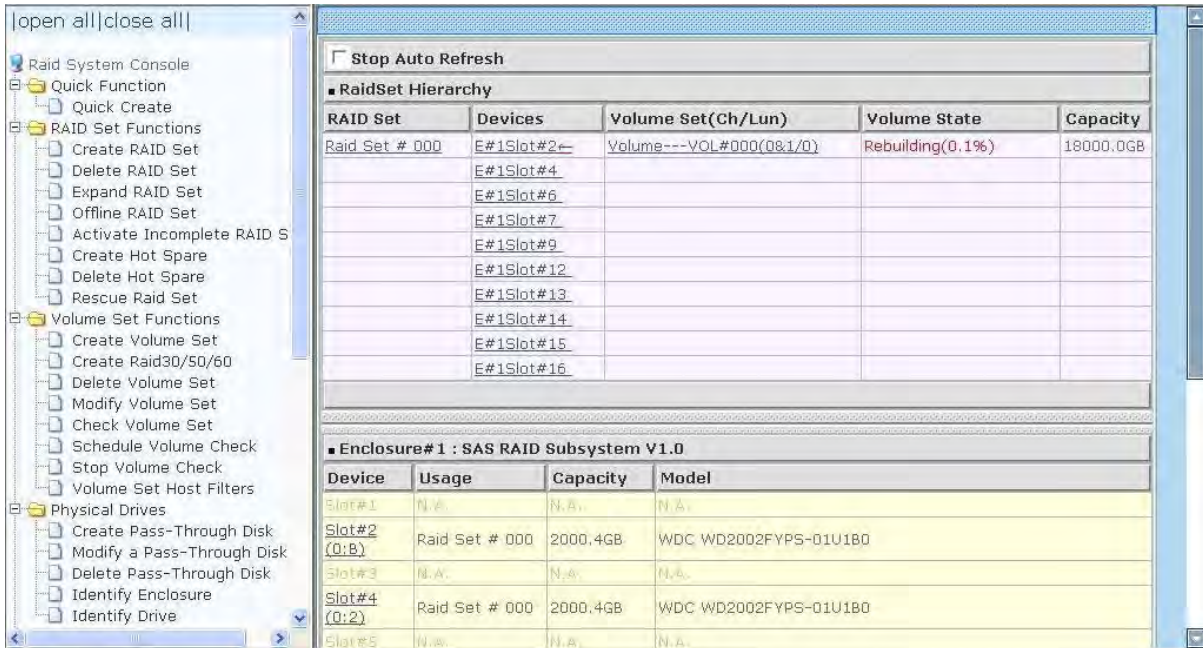

8. **To verify if Disk is really failed or still usable, you can try to power on the Disk. To power on Disk in Slot#1 of Enclosure#1, select "Rescue RAID Set".** In the "Enter The Keyword" box, type "**PowerOnDisk**", press space bar, and then type "**Enclosure#1 Slot#1**". The contents of "Enter The Keyword" box will become "**PowerOnDisk Enclosure#1 Slot#1**". Tick "Confirm The Operation" and click "Submit".

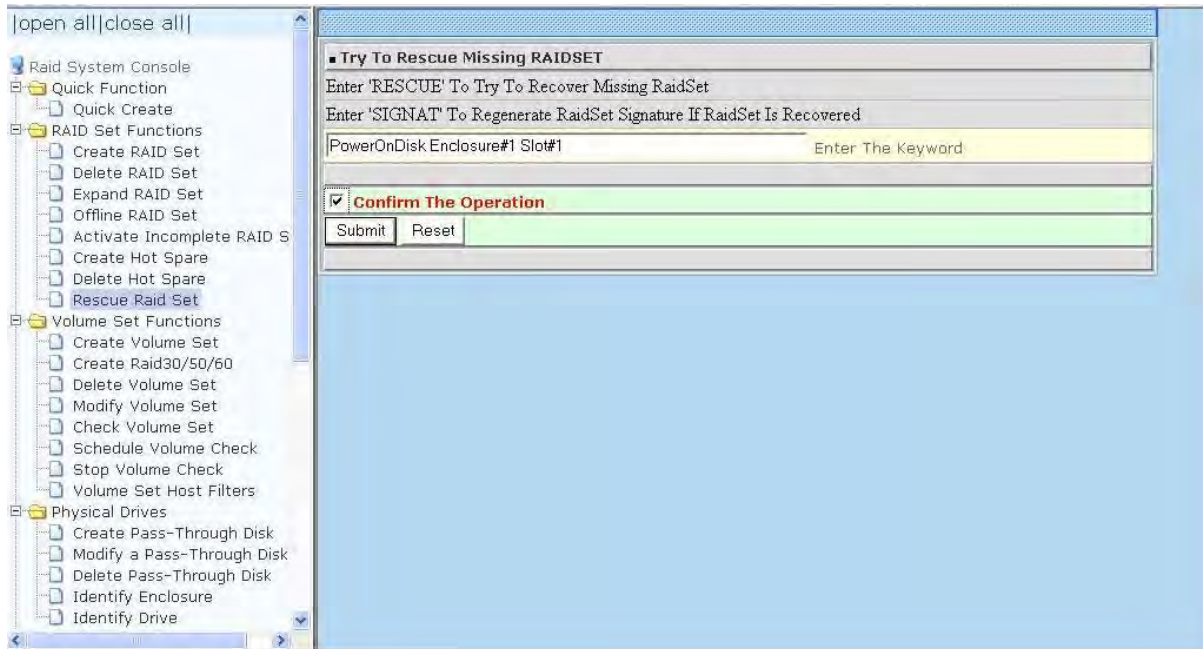

NOTE: Sometimes the "PowerOnDisk" command will need to wait for several seconds before command execution is completed (web GUI is updated), specially when the RAID Subsystem is active or busy.

9. If the Disk in Enclosure#1 Slot#1 is **still good**, the Disk will be turned on.

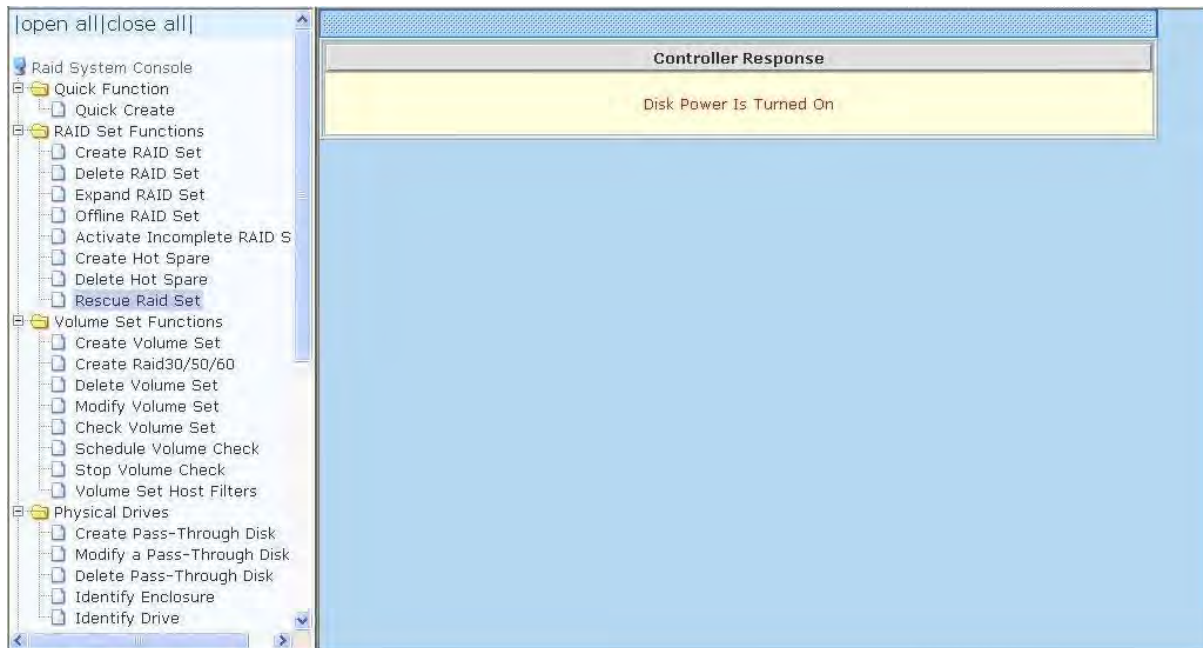

IMPORTANT: If the disk is really failed and cannot power on, replace the failed disk with a new one.

If the failed disk is still good, observe this particular disk. If this disk fails again, replace it with a new one.

Use the disk manufacturer's utility/disk tool to verify the health status of the failed disk.

- If the Disk in Enclosure#1 Slot#1 is **still good**, the Disk will automatically become Hot Spare. Note that this function (new disk will automatically become hot spare) will only work if there is a previously configured hot spare that has replaced a failed disk.

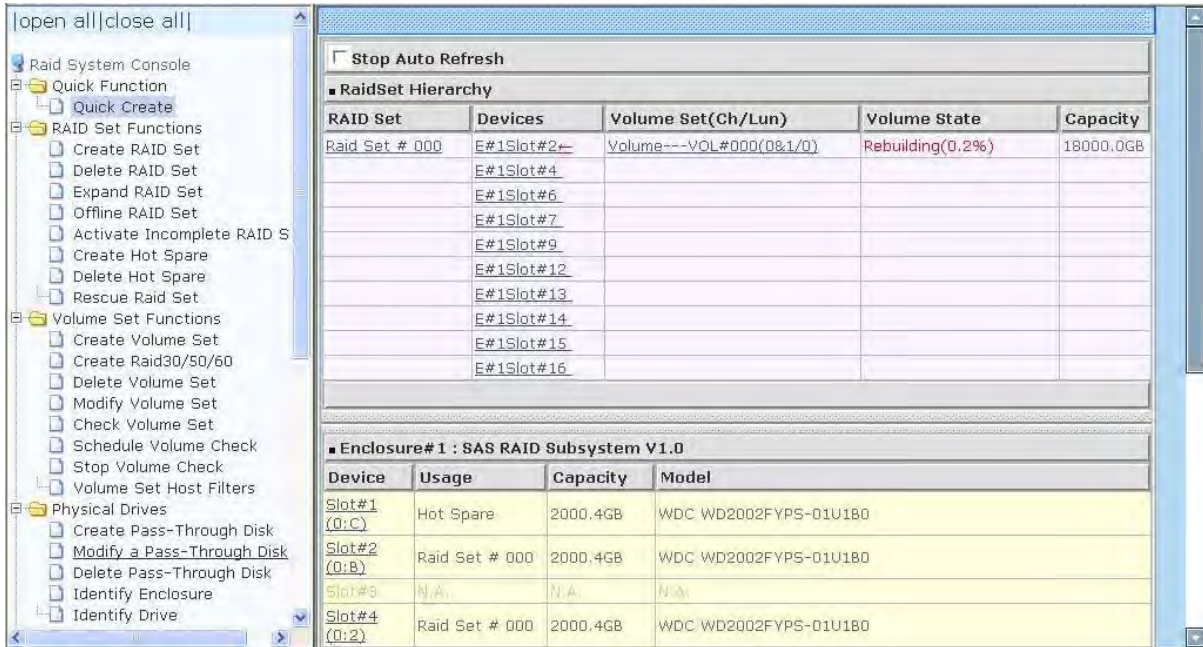

- The System Event Information will show "Device Inserted" for Enc#1 Slot#1 after executing the "PowerOnDisk" command and the Disk is still good.



3. Additional Information

- a. When a disk has failed in Enclosure#1 Slot#1 and you try to **power off Enclosure#1 Slot#1** using the command "**PowerOffDisk Enclosure#1 Slot#1**", and then **remove** the Disk from the slot and **insert a new Disk**, the Disk will not power on because the Disk Slot is still in power off state.

You need to use the command "**PowerOnDisk Enclosure#1 Slot#1**" to power on the Disk Slot.



NOTE: Sometimes the "PowerOffDisk" and "PowerOnDisk" command will need to wait for several seconds before command execution is completed (web GUI is updated), specially when the RAID Subsystem is active or busy.

- b. When a disk has failed in Enclosure#1 Slot#1 and you try to **power off Enclosure#1 Slot#1** using the command "**PowerOffDisk Enclosure#1 Slot#1**", remove the failed disk, and then **power-cycle the RAID Subsystem**, the Disk Slot will be powered on. If you insert a new Disk in Enclosure#1 Slot#1, the Disk will be detected. Take note that using "Restart Controller" function, instead of power-cycle, still will not power on the Disk Slot.



NOTE: Sometimes the "PowerOffDisk" command will need to wait for several seconds before command execution is completed (web GUI is updated), specially when the RAID Subsystem is active or busy.